

INTRODUCTION (1)

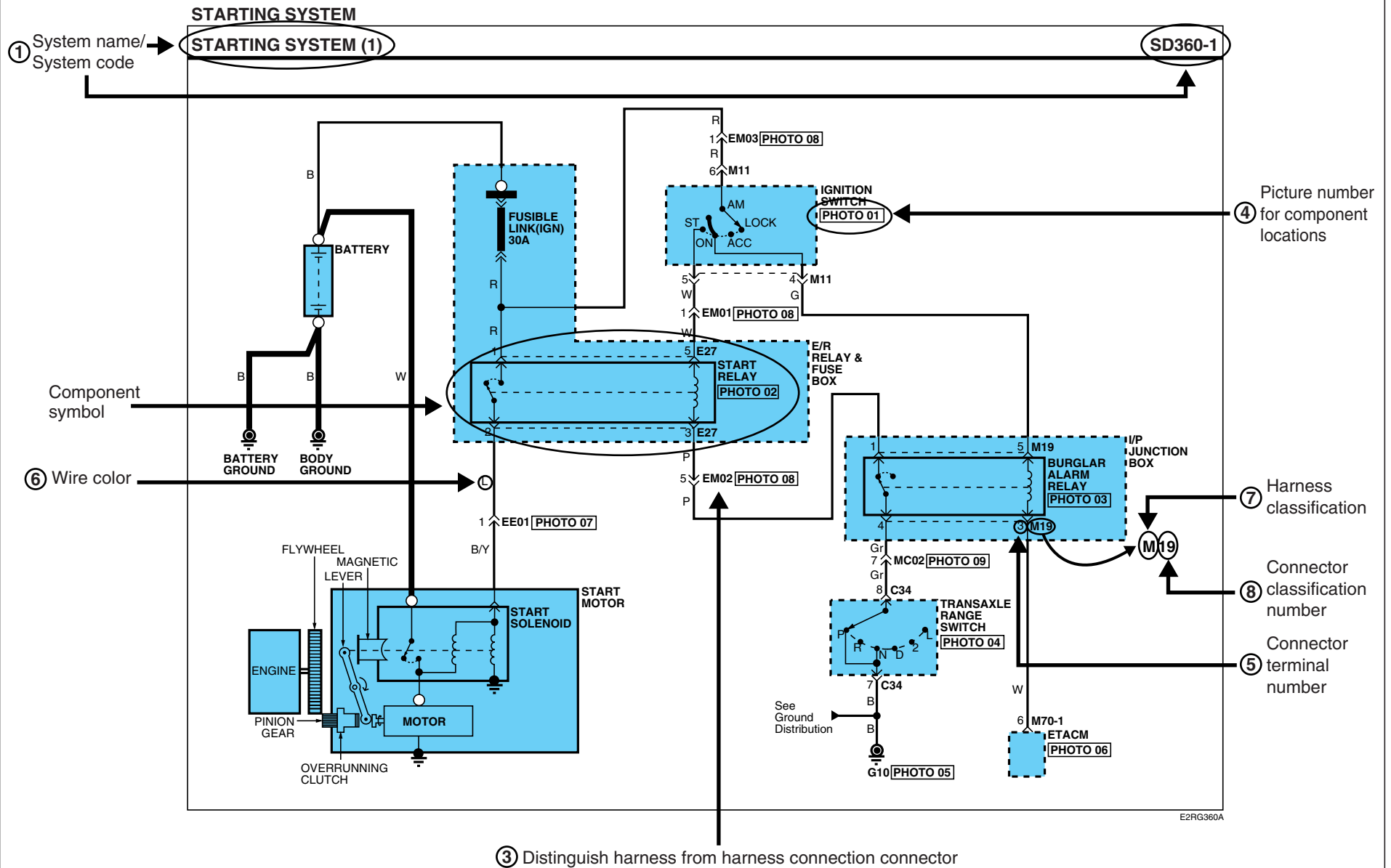

INTRODUCTION

INTRODUCTION (2)

GI-2

STARTING SYSTEM

STARTING SYSTEM (2)

SD360-2

② Connector configurations (components)

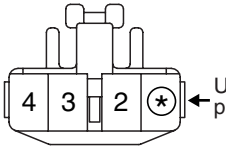
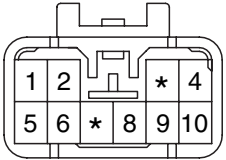
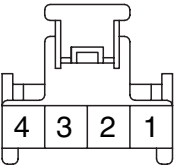
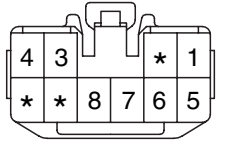
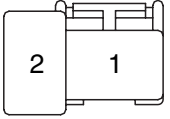
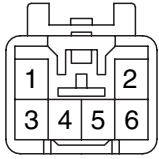
<p>M05</p>  <p>KET_090II_04F_W</p>	<p>M06</p>  <p>KET_090II_10M_W</p>	<p>M11</p>  <p>KUM_AR_04F_W</p>	<p>M13</p>  <p>KET_090II_10F_W</p>
<p>M67</p>  <p>AMP_PLM2_02F_B</p>	<p>M81</p>  <p>KET_090II_06M_W</p>	<p>BLANK</p>	<p>BLANK</p>

E2RG360B

Explanation of connector code

M05

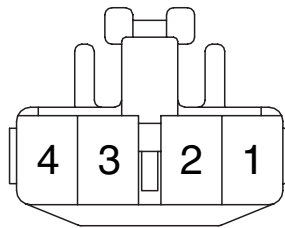

KET_090II_04F_W

a b c d e

a : Connector manufacturer

b : Terminal series number

c : The number of connector terminals

d : Connector distinguishing

Female Pin : F

Male Pin : M

e : Connector color abbreviations

- B (Black)
- Br (Brown)
- G (Green)
- Gr (Gray)
- L (Blue)
- R (Red)
- W (White)
- Y (Yellow)

① Pages by system/ Name of Schematic diagram

- Each page is consisted of circuits by system. This schematic diagram includes the path of electricity flow, connection condition for each switch, and the function of other relevant circuits at once. It is applicable to real service work.
- It is very important to understand relevant circuits exactly before troubleshooting diagnosis.
- Circuits by system depends upon part number and are indicated on schematic diagram index.

② Connector configuration (components)

- The connector figure of components in the schematic diagram by system is indicated on the last page of schematic diagram.
- It shows the front of the connector on the harness side when not to the harness connector. The terminal number on each connector can be obtained by following the pattern used in ⑤ connector view and numbering order. Unused terminals are marked with an asterisk (*).

③ Connector configurations (connection between harnesses)

- When connecting the harness with connector between harnesses, it shows female and male connectors and indicates them on the connector configurations group.

EM02

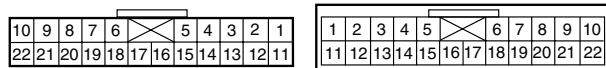

④ Component locations

- To find the components easily, a component locations diagram is indicated with "PHOTO NO" on the lower portion of the component name.
- To make it easy to distinguish connectors, the connector in the picture is indicated being installed in the vehicle.

PHOTO 03

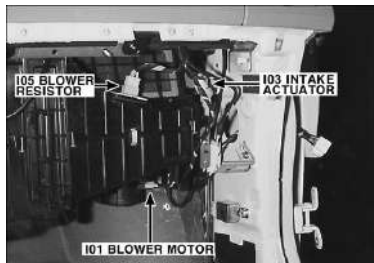

⑤ CONNECTOR VIEW AND NUMBERING ORDER

Female	Male	Remarks
		<p>It is not the shape of the connector housing, but the connector pin that distinguishes between male or female connectors. When numbering female and male connectors, refer to the numbering order in the following table. Some connectors may not follow this method of numbering order. For individual detailed numbering, refer to the CONNECTOR CONFIGURATIONS.</p>
		<p>Numbered in order from upper right to lower left</p> <p>Numbered in order from upper left to lower right</p>

NOTE

UNLESS OTHERWISE STATED, ALL CONNECTOR VIEWS ARE FROM THE TERMINAL SIDE OF THE CONNECTOR.

INTRODUCTION

INTRODUCTION (4)

GI-4

⑥ WIRE COLOR ABBREVIATIONS

The following abbreviations are used to identify wire colors in the circuit schematics.

Symbol	Color of wire	Symbol	Color of wire
B	Black	O	Orange
Br	Brown	P	Pink
G	Green	R	Red
Gr	Gray	W	White
L	Blue	Y	Yellow
Lg	Light Green	Pp	Purple
T	Tan	LI	Light Blue

* **(Y/B)**: Black stripe with yellow ground (2 colors)

↑ ↑
the color of the color of
background stripe

⑦ HARNESS CLASSIFICATION

Electrical wiring connectors are classified according to the wiring parts in the Harness Layouts.

Symbol	Harness name	Location
E	Engine, Battery harness	Engine compartment
M	Main, Socket EXT. harness	Passenger compartment, Floor
S	Seat harness	Seat
C	Control, Injector, Ignition, Oil control valve harness	Engine compartment, Passenger compartment
R	Roof, Sunroof, Tail gate harness	Roof, Tail gate
I	Air bag harness	Under crash pad and Floor
D	Door harness	Door

* It depends on vehicles, it is necessary to check the harness name symbol on the harness layouts for detailed symbol.

⑧ CONNECTOR IDENTIFICATION

A connector identification symbol consists of a wiring harness location classification symbol corresponding to a wiring harness location and number corresponding to the connector. These connector locations can be found in the HARNESS LAYOUTS.

For example:

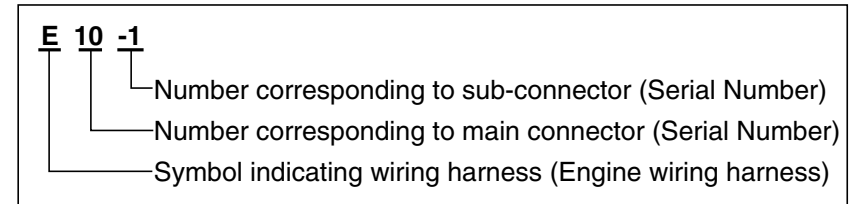

NOTE

Connectors which connect each wiring harness are represented by the following symbols.

For example:

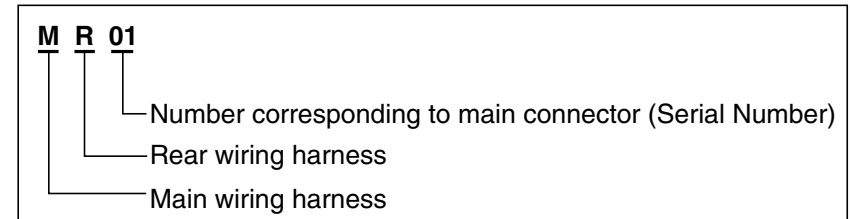

JUNCTION BLOCK IDENTIFICATION

A junction block identification symbol consists of a wiring harness location classification symbol corresponding to a wiring harness location and number corresponding to the connector in the junction block.

For example:

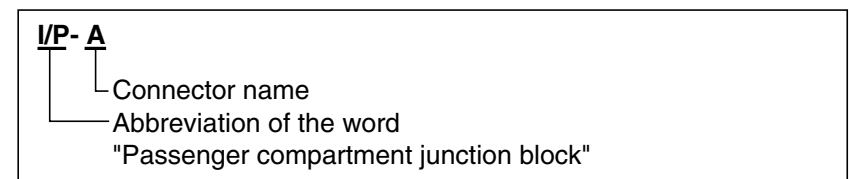

HARNESS LAYOUTS

Harness layouts show the routing of the major wiring harnesses, the in-line connectors and the splices between the major harnesses. These layouts will make electrical troubleshooting easier.

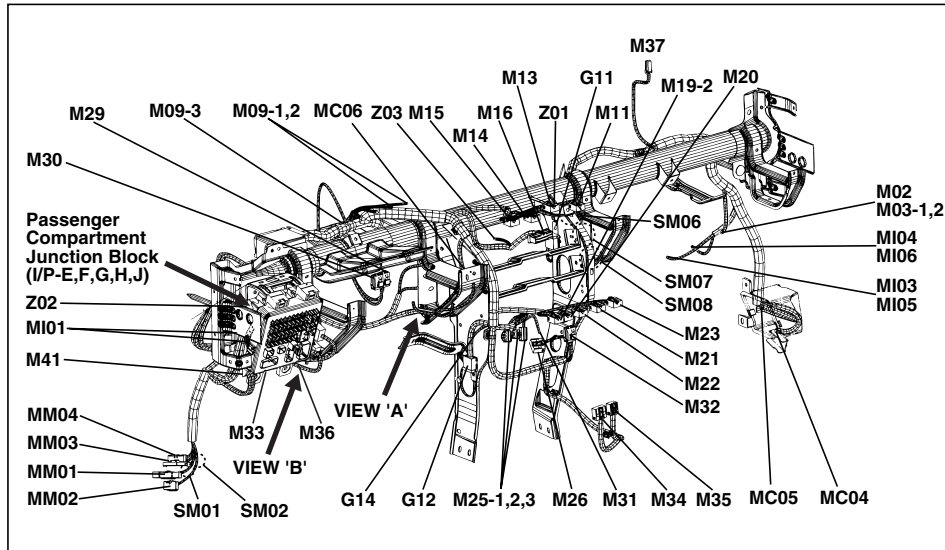







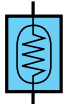
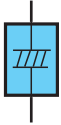

SYMBOLS (1)

Section	Symbol	Meaning	Section	Symbol	Meaning	Section	Symbol	Meaning	Section	Symbol	Meaning
C O M P O N E N T		A solid line means the entire component is shown.	C O N N E C T O R		Shows the name of each connector on the component location index for reference.	S H I E L D W I R E		This represents RFI (Radio Frequency Interference) Shielding around a wire. The shielding is always connected to ground.	L A M P		Double filament
		A broken line indicates only part of the component is shown.			Indicates the number of corresponding terminal. (Only relevant terminal on the corresponding schematic diagram).			Single filament			
		This means the connector connects directly to the component.	W I R E		A wavy line means the wire is broken but is to be continued.	J O I N T C O N N E C T O R		This is a connector showing the joining wires.	D I O D E		Diode
		This indicates the connector connects to a lead (pigtail), wired directly to the component.			Wire insulation is yellow with a red strip.			Led diode			
		This indicates a screw terminal on the component.	S P L I C E S		Current path is continued on the same page or another page. The arrow shows the direction of current flow. You should look for the "A" in the marked position.	S L O W B L O W		Power supplied at all times. Name Capacity	T R		NPN
		This ground symbol (dot and 3 lines overlapping the component) means the housing of the component is attached to a metal part of the vehicle.			A wire connects to another circuit. The wire is shown again on that circuit which the arrow is pointing.			PNP			
		The name of the component appears next to its upper right corner.	G R O U N D		Name of Circuit	F U S E		This means power is supplied with the ignition on position. This means the short bar connects to other fuses. Identification Current rating	G E N E R A L C O M P O N E N T S Y M B O L		These switches move together: a dashed line shows a mechanical connection between them.
		Shows the number of pictures for component location.			Splices are numbered and shown as a dot with circle. The exact location and connection of these splices may vary among vehicles.			Identification Current rating			Switch (1 contact point)
					This symbol means the end of the wire is attached to a metal part of the vehicle.	C O N T R O L L O C A T I O N					Heater

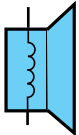
SYMBOLS

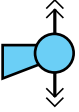
SYMBOLS (2)

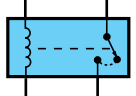
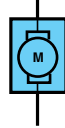
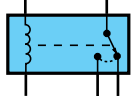
GI-7

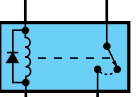
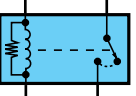
Section	Symbol	Meaning	Section	Symbol	Meaning
GENERAL COMPONENTS SYMBOL		Sensor	GENERAL COMPONENTS SYMBOL		Condenser
		Sender			Speaker
		Injector			Horn, Buzzer, Siren, Chime Bell
		Solenoid			Normally open contact
		Motor		This is a relay shown with no current flowing through its coil. When a current flows through coil, contact will toggle.	
		Battery		Diode interior relay	
				Resistance interior relay	

TROUBLESHOOTING INSTRUCTIONS (1)

GI-8

TROUBLESHOOTING INSTRUCTIONS

TROUBLESHOOTING PROCEDURES

The following five-step troubleshooting procedure is recommended.

1. Verify the customer's complaints

Turn on all the components in the problem circuit to check the accuracy of the customer's complaints. Note the symptoms. Do not begin disassembly or testing until you have narrowed down the probable causes.

2. Read and analyze the schematic diagram

Locate the schematic for the problem circuit. Determine how the circuit is supposed to work by tracing the current paths from the power source through the system components to ground. If you do not understand how the circuit should work, read the circuit operation text. Also check other circuits that share with the problem circuit. The name of circuits that share the same fuse, ground, or switch, for example, are referred to on each diagram. Try to operate any shared circuits you did not check in step 1. If the shared circuit works, the shared wiring is okay, and the cause must be within the wiring used only by the problem circuit.

If several circuits fail at the same time, the fuse or ground is a likely cause.

3. Inspect the circuit/ component with the problem isolated

Make a circuit test to check the diagnosis you made in step 2. Remember that a logical, simple procedure is the key to efficient troubleshooting. Narrow down the probable causes using the troubleshooting hints and system diagnosis charts. Test for the most likely cause of failure first. Try to make tests at points that are easily accessible.

4. Repair the problem

Once the problem is found, make the necessary repairs.

5. Make sure the circuit works

Repeat the system check to be sure you have repaired the problem. If the problem was a blown fuse, be sure to test all of the circuits on that fuse.

TROUBLESHOOTING EQUIPMENT

VOLTMETER AND TEST LAMP

Use a test lamp or a voltmeter on circuits without solidstate units and use a test lamp to check for voltage. A test lamp is made up of a 12-volt light bulb with a pair of leads attached. After grounding one lead, touch the other lead to various points along the circuit where voltage should be present. When the bulb goes on, there is voltage at the point being tested.

CAUTION

A number of circuits include solid-state modules, such as the Engine Control Module(ECM), used with computer command control injection. Voltage in these circuits should be tested only with a 10-megaohm or higher impedance digital multimeter. Never use a test lamp on circuits that contain solid state modules. Damage to the modules may result.

A voltmeter can be used in place of a test lamp. While a test lamp shows whether the voltage is present or not, a voltmeter indicates how much voltage is present.

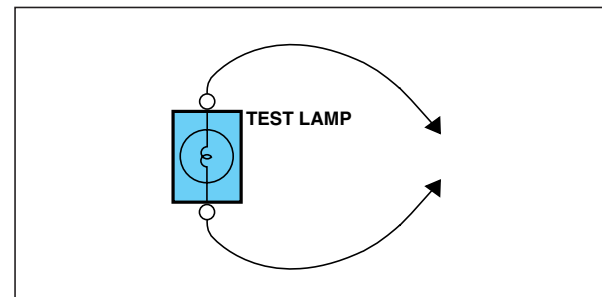
**SELF-POWERED TEST LAMP AND OHMMETER**

Use a self-powered test lamp or an ohmmeter to check for continuity. The ohmmeter shows how much resistance there is between two points along a circuit. Low resistance means good continuity.

TROUBLESHOOTING INSTRUCTIONS

TROUBLESHOOTING INSTRUCTIONS (2)

GI-9

CAUTION

Never use a self-powered test lamp on circuits that contain solid state modules. Damage to these modules may result.

An ohmmeter can be used in place of a self-powered test lamp. The ohmmeter shows how much resistance there is between two points along a circuit. Low resistance means good continuity.

Circuits which include any solid-state devices should be tested only with a 10-megaohm or higher impedance digital multimeter. When measuring resistance with a digital multimeter, the battery negative terminal should be disconnected. Otherwise, there may be incorrect readings. Diodes and solid-state devices in a circuit can make an ohmmeter give a false reading. To find out if a component is affecting a measurement, take one reading, reverse the leads and take a second reading. If different the solid-state device is affecting the measurement.

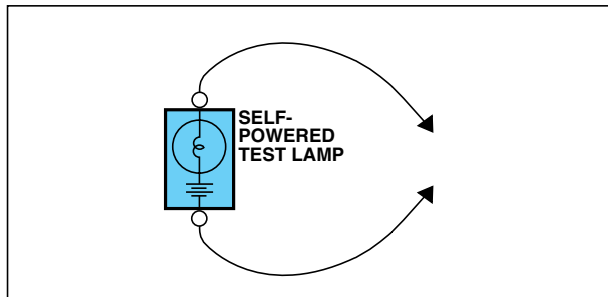

JUMPER WIRE WITH FUSE

Use a jumper wire with a fuse to by-pass an open circuit.

A jumper wire is made up of an in-line fuse holder connected to a set of test leads. This tool is available with small clamp connectors providing adaption to most connectors without damage.

CAUTION

Do not use a fuse with a higher rating than the specified fuse that protects the circuit being tested. Do not use this tool in any situation to substitute an input or output at the solid-state control module, such as ECM, TCM, etc.

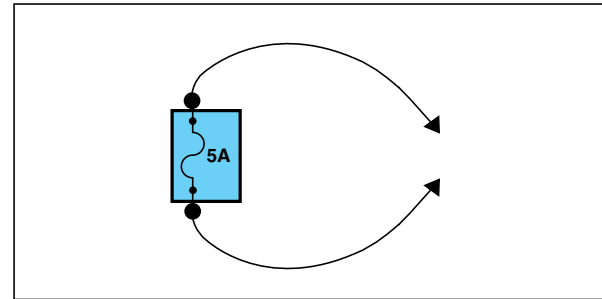

SHORT FINDER

A short finder is available to locate a short to ground. The short finder creates a pulsing magnetic field in the shorted circuit and shows you the location of the short through body trim or sheet metal.

TROUBLESHOOTING TEST

1. TESTING FOR VOLTAGE

This test measures voltage in a circuit. When testing for voltage at a connector, you do not have to separate the two halves of the connector. Instead, probe the connector from the back(backprobe). Always check both sides of the connector because dirt and corrosion between its contact surfaces can cause electrical problems.

- A. Connect one lead of a test lamp or voltmeter to a ground. If you are using a voltmeter, be sure it is the voltmeter's negative test lead you have connected to ground.
- B. Connect the other lead of the test lamp or voltmeter to a selected test point(connector or terminal).
- C. If the test lamp glows, there is voltage present. If you are using a voltmeter, note the voltage reading. A loss of more than 1 volt from specification indicates a problem.

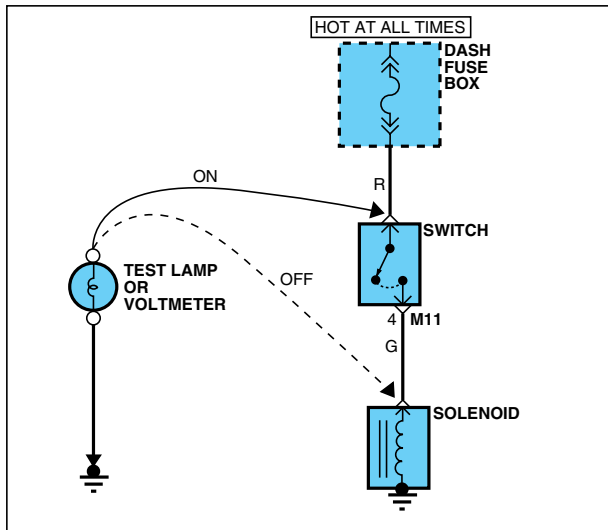

2. TESTING FOR CONTINUITY

- A. Disconnect the battery negative terminal.
- B. Connect one lead of a self-powered test lamp or ohmmeter to one end of the part of the circuit you wish to test. If you are using an ohmmeter, hold the leads together and adjust the ohmmeter to read zero ohms.
- C. Connect the other lead to the other end.
- D. If the self-power test lamp glows, there is continuity. If you are using an ohmmeter, low or zero resistance means good continuity.

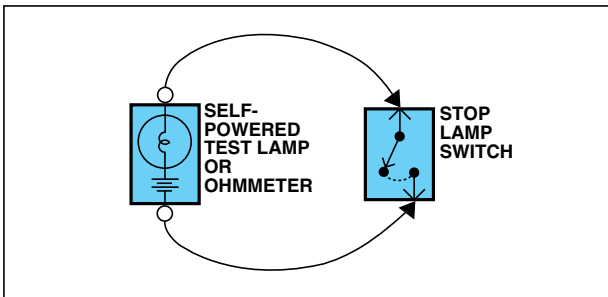

3. TESTING FOR SHORT TO GROUND

- A. Disconnect the battery negative terminal.
- B. Connect one lead of a self-powered test lamp or an ohmmeter to the fuse terminal on the load side.
- C. Connect the other lead to a ground.
- D. Beginning near the fuse block move the harness from side to side. Continue this procedure (about six inches apart) while watching the self-powered test lamp or ohmmeter.
- E. When the self-powered test lamp glows, or ohmmeter registers, there is a short to a ground in the wiring near that point.

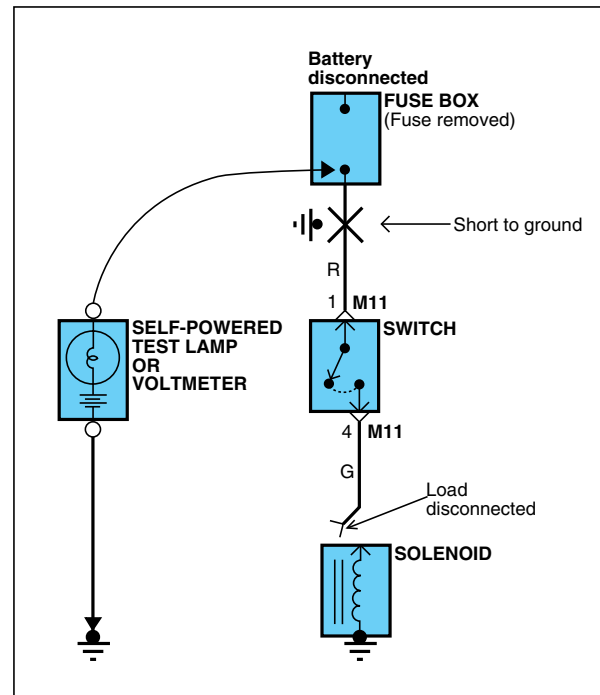

4. TESTING FOR A SHORT WITH A SHORT FINDER

- A. Remove the blown fuse. Leave the battery connected.
- B. Connect the short finder across the fuse terminals.
- C. Close all switches in series in the circuit that is being testing.
- D. Turn on the short circuit locator. It sends pulses of current to the short.
This creates a pulsing magnetic field around the wiring between the fuse box and the short.
- E. Beginning at the fuse box, slowly move the short finder along the circuit wiring. The meter will show current pulses through sheet metal and body trim. As long as the meter is between the fuse and the short, the needle will move with each current pulse. Once the meter is moved past the point of the short, the needle will stop moving. Check around this area to locate the cause of the short circuit.

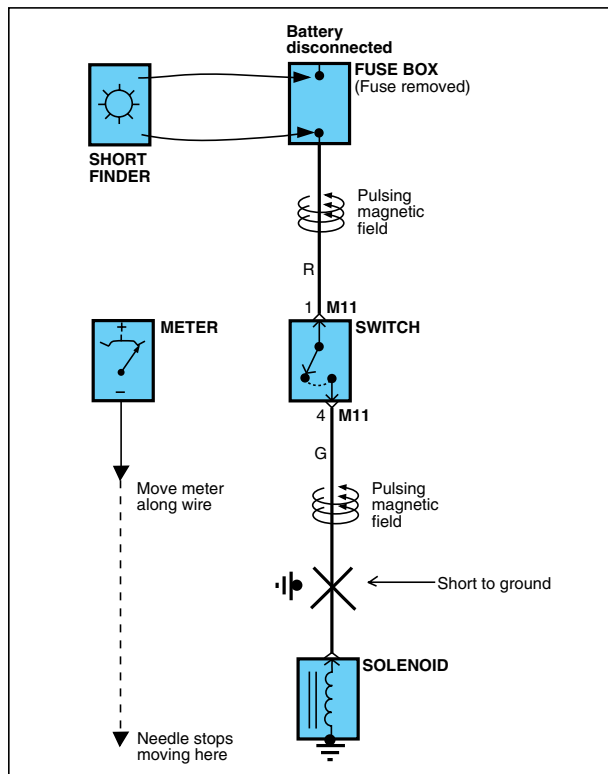

*** REFERENCE SERVICE TOOLS**

Tool Number	Tool Name
TRK00A	Wiring Repair Kit (Standard Kit)
TRK001	Wire Stripper Set
TRK002	Remover Tool Set
TRK003	Terminal Tension Gauge Set
TRK004	Cable Tie Set
TRK005	Shrink Tube Set
TRK006	Jump Connector Kit(A)
TRK007~10	General Connector Kit(B~E)
TRK011	Terminal With Lead Wire Kit(F)
TRK012	Composition Kit(G)
TRK013	Lead Wire Set
TRK014	Carrying Case
TRK015	User's Guide & Parts Information
TRK016	Inner Box(Large)
TRK017	Inner Box(Small)
TRK018	Solder

* For more details, refer to the User's guide & parts Information of the Wiring Repair Kit (Pub. No. : OSG200208).

*** Wiring Repair Kit**

[Standard Kit (TRK00A)]

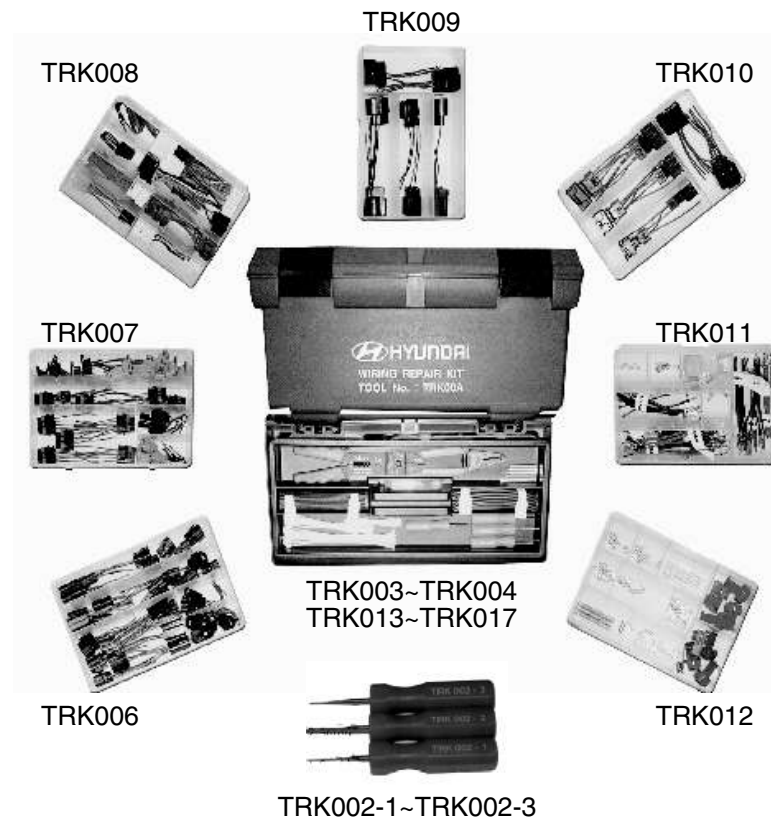

*** Optional Items**



REWORK PROCEDURE

1. Use of Wire stripper set (TRK001)

- 1) Disconnect the battery cable.
- 2) Choose the correct clamping slot for the wire and strip off the wire coat.
- ◎ If the incorrect crimping slot is used, the terminal may be damaged and may not fit into the connector.

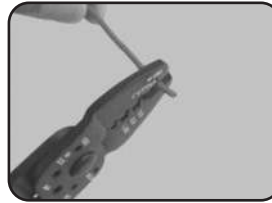

2. Use of Remover tool set (TRK002)

► **Flat tip type** : Removal of single locking male/female terminal from the connector.

- 1) Remove the front or rear retainer (holder, stopper) of the connector.



- 2) Ensure that the tip of the tool is inserted into the gap between the elastic arm of key and terminal.



- 3) Remove the terminal and check the terminal condition, if there is a damaged, replace it with a new terminal.

► **Double tip type** : Removal of double locking male/female terminal from the connector.



3. Use of Terminal tension gauge set (TRK003)

- 1) Select the tension gauge that matches the female terminal to be checked.



- 2) Insert a tension gauge into the female terminal and check the terminal condition. (as shown in the photograph)



◎ If the tension of female terminal is not tight enough, remove it and replace the terminal and wire assembly (including seal).



4. Use of Ring terminal (TRK012-4)

1) Strip off about 5mm of the wire coat at the end of the wire.



2) Joint the stripped wire with ring terminal and crimp using wire stripper.

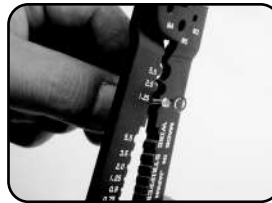

3) Put the shrink tube over the connection area and shrink the tube using electrical hot gun.

**5. Use of Inline solder (TRK012-5) and Shrink tube set (TRK005)**

1) Strip off about 5mm of the wire coat at the end of the wires.



2) Insert each wire into the opposite ends of the inline solder and crimp using wire stripper.



3) Put the shrink tube over the connection area and shrink the tube using electrical hot gun.



◎ Shrink tube should be securely wrapped around the inline solder area.

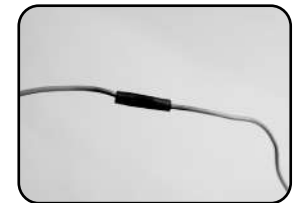

6. Use of Terminal with lead wire kit (TRK011)

- 1) Remove the damaged connector and terminal using remover tool.



- 2) Select the right wire, which is fitted with the terminal specification from terminal with lead wire box and cut of the end of wire using wire stripper.

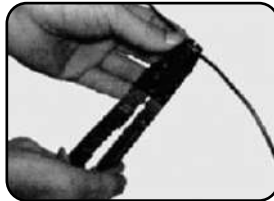

- 3) Put the end of each cut off wire in the middle of the splice joint terminal and compress using wire stripper.



- 4) Put the shrink tube over the connection area and shrink the tube using electrical hot gun.

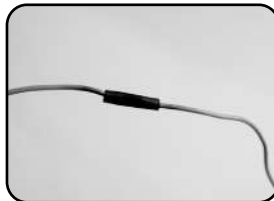

- 5) Insert the terminal with lead wire into the connector.



FUSE & RELAY INFORMATIONS (1)

SD100-1

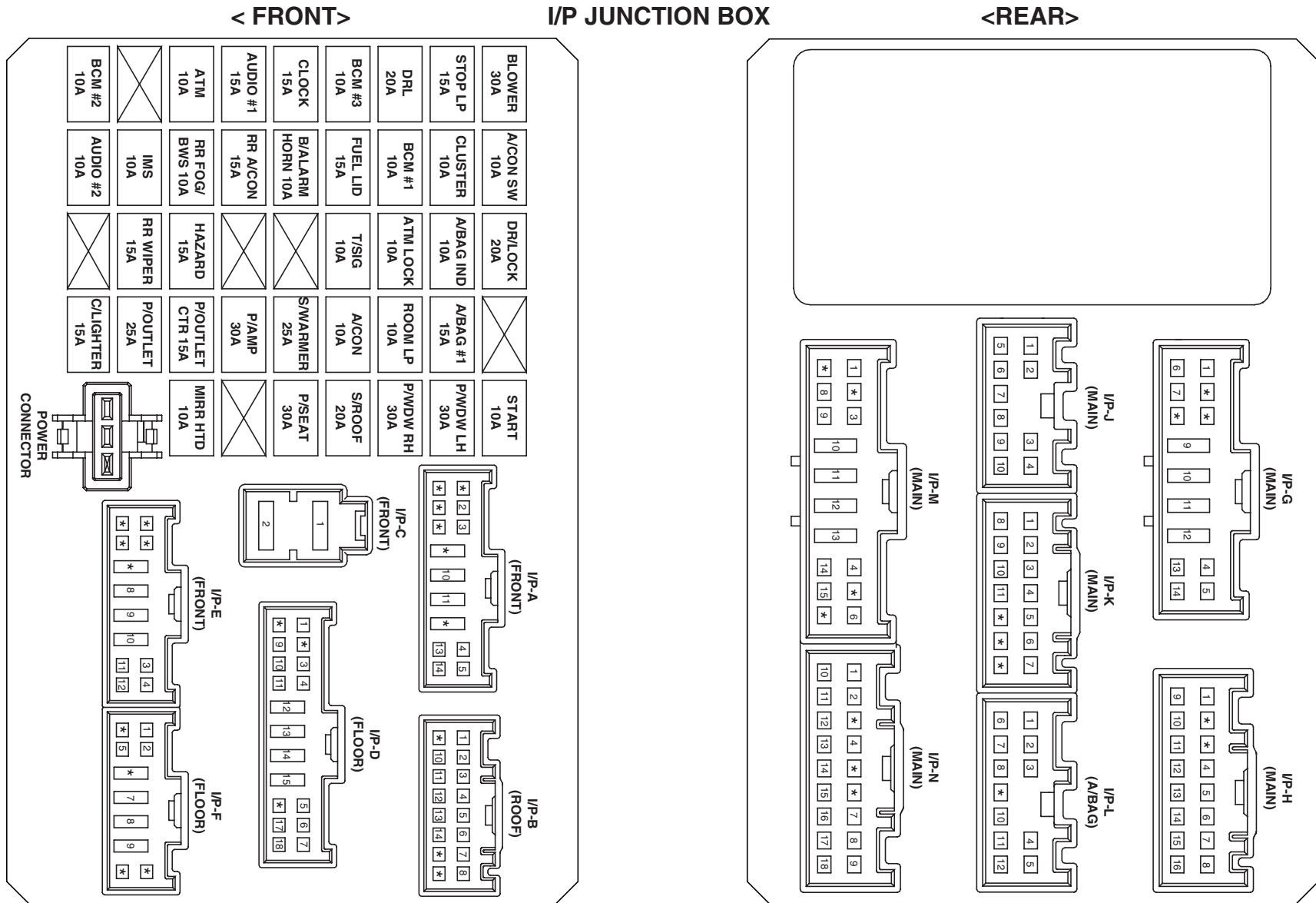

✳️ USE THE DESIGNATED FUSE ONLY

FUSE & RELAY INFORMATIONS

FUSE & RELAY INFORMATIONS (2)

SD100-2

CIRCUIT

FUSE	(A)	Circuit Protected	FUSE	(A)	Circuit Protected
C/LIGHTER	15A	CIGARETTE LIGHTER	P/AMP	30A	DELPHI AMP, MOBIS AMP
P/OUTLET	25A	FRONT POWER OUTLET, REAR POWER OUTLET	S/WARMER	25A	SEAT WARMER CONTROL MODULE
P/OUTLET CTR	15A	CENTER POWER OUTLET	P/SEAT	30A	POWER SEAT SWITCH
AUDIO #2	10A	DRIVER POWER OUTSIDE MIRROR SWITCH, AUDIO, DIGITAL CLOCK, ATM KEY LOCK CONTROL MODULE	RR A/CON	15A	ICM RELAY BOX
RR WIPER	15A	MULTIFUNCTION SWITCH, REAR WIPER CONTROL MODULE, REAR WIPER MOTOR	RR FOG/BWS	10A	ICM RELAY BOX
IMS	10A	RAIN SENSOR	S/ROOF	20A	SUNROOF MOTOR
BCM #2	10A	RHEOSTAT, BCM, INSTRUMENT CLUSTER	B/ALARM HORN	10A	BURGLAR ALARM HORN RELAY
A/CON	10A	A/C CONTROL MODULE, INCAR & HUMIDITY SENSOR, HIGH BLOWER RELAY, REAR A/CON SWITCH, ICM RELAY BOX, AQS SENSOR, FUSIBLE LINK BOX (DSL), SUNROOF MOTOR, BLOWER RELAY, ELECTRO CHROMIC MIRROR	MIRR HTD	10A	REAR DEFOGGER SWITCH, POWER OUTSIDE MIRROR MOTOR
BLOWER	30A	BLOWER RELAY, BLOWER MOTOR, A/C CONTROL MODULE	DR/LOCK	20A	DOOR LOCK (UN) RELAY, ICM RELAY BOX
A/CON SW	10A	A/C CONTROL MODULE	STOP LP	15A	STOP LAMP SWITCH
A/BAG #1	15A	SRS CONTROL MODULE	FUEL LID	15A	FUEL LID SWITCH
A/BAG IND	10A	PAB CUT OFF SWITCH, INSTRUMENT CLUSTER	ATM	10A	KEY SOLENOID, SEMI ACTIVE SOLENOID (GSL), SPORTS MODE SWITCH
T/SIG	10A	HAZARD SWITCH	ROOM LP	10A	INSTRUMENT CLUSTER, LUGGAGE LAMP, MAP LAMP, REAR PERSONAL LAMP, ROOM LAMP, DOOR LAMP, CARGO LAMP, VANITY LAMP SWITCH
ATM LOCK	10A	MULTIFUNCTION SWITCH, STEERING ANGLE SENSOR, ESP SWITCH, ATM KEY LOCK CONTROL MODULE, SEAT WARMER MODULE	BCM #3	10A	IGNITION KEY ILL. & DOOR WARNING SWITCH, BCM, SECURITY INDICATOR
BCM #1	10A	OIL LEVEL SENSOR MODULE, BCM	CLOCK	15A	A/C CONTROL MODULE, DATA LINK CONNECTOR, DIGITAL CLOCK
CLUSTER	10A	INSTRUMENT CLUSTER, PRE-EXCITATION RESISTOR, BCM, SEMI ACTIVE ENGINE MOUNTING CONTROL MODULE (GSL), GENERATOR	AUDIO #1	15A	DELPHI AUDIO, MOBIS AUDIO
START	10A	BURGLAR ALARM RELAY	HAZARD	15A	HAZARD SWITCH, HAZARD RELAY
DRL	20A	ICM RELAY BOX	P/WDW LH	30A	POWER WINDOW MAIN SWITCH, REAR POWER WINDOW SWITCH LH
			P/WDW RH	30A	POWER WINDOW MAIN SWITCH, REAR POWER WINDOW SWITCH RH

✘ USE THE DESIGNATED FUSE ONLY

U/H JUNCTION BOX

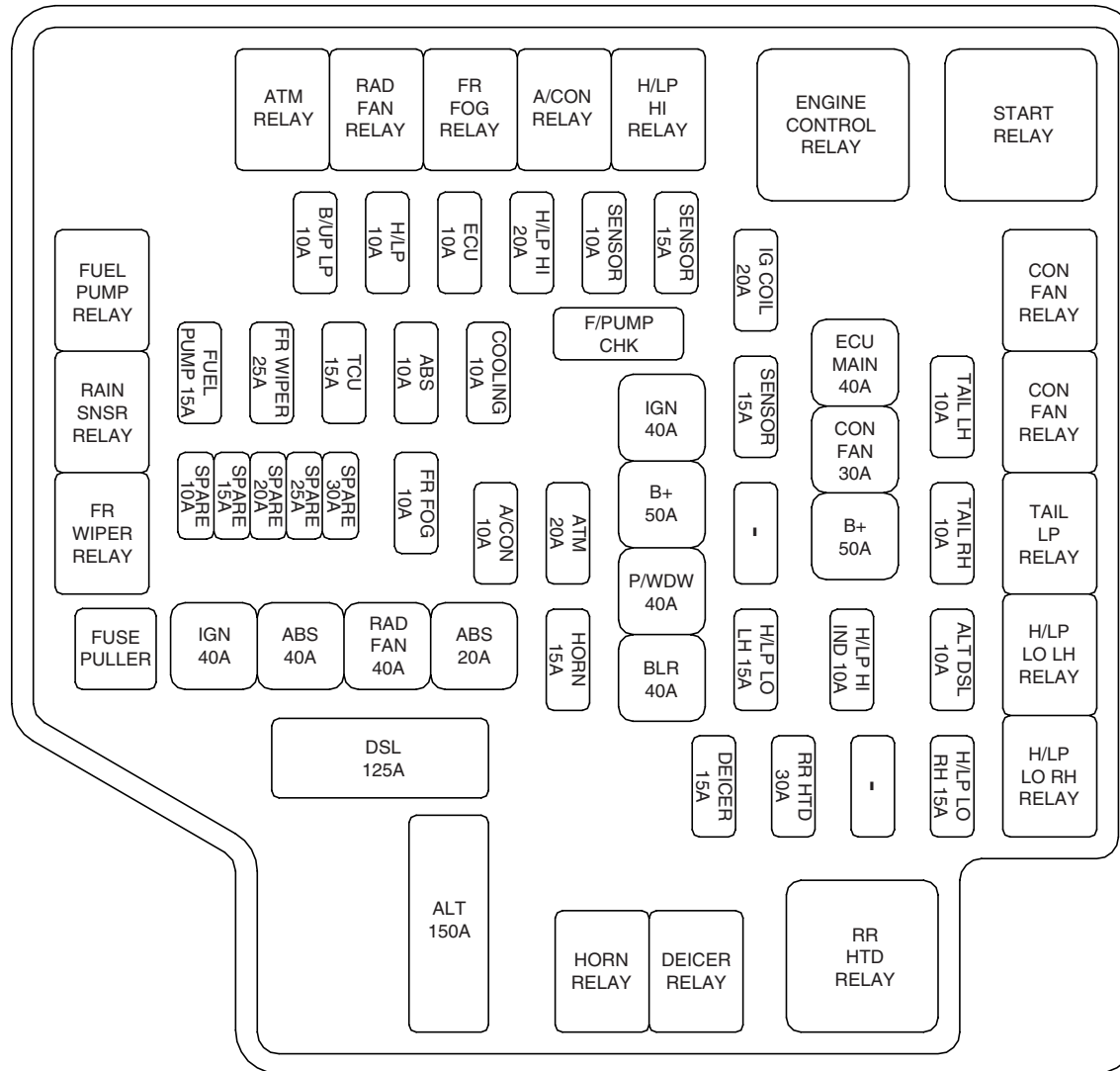

※ USE THE DESIGNATED FUSE AND RELAY ONLY

FUSE & RELAY INFORMATIONS

FUSE & RELAY INFORMATIONS (4)

SD100-4

CIRCUIT

FUSE	(A)	Circuit Protected	FUSE	(A)	Circuit Protected
DSL	125A	FUSIBLE LINK BOX	H/LP	10A	I/P JUNCTION BOX
ALT	150A	GENERATOR	FR WIPER	25A	FR WIPER RELAY, RAIN SNSR RELAY, FRONT WIPER MOTOR, MULTIFUNCTION SWITCH
A/CON	10A	A/CON RELAY	H/LP HI	20A	H/LP HI RELAY
RR HTD	30A	RR HTD RELAY	H/LP HI IND	10A	HEAD LAMP, INSTRUMENT CLUSTER
BLR	40A	I/P JUNCTION BOX	IGN #1	40A	IGNITION SWITCH
B+ #2	50A	I/P JUNCTION BOX	IGN #2	40A	IGNITION SWITCH, START RELAY
P/PDW	40A	I/P JUNCTION BOX	B+ #1	50A	I/P JUNCTION BOX
ABS #1	40A	ABS CONTROL MODULE, ESP CONTROL MODULE, MULTIPURPOSE CHECK CONNECTOR	ATM	20A	ATM RELAY(GSL), 4WD ECM, ATM CONTROL RELAY(DSL)
ABS #2	20A	ABS CONTROL MODULE, ESP CONTROL MODULE, MULTIPURPOSE CHECK CONNECTOR	TCU	15A	PCM(GSL), TCM(DSL)
DEICER	15A	DEICER RELAY	ALT DSL	10A	GENERATOR
ECU MAIN	40A	ENGINE CONTROL RELAY	ECU	10A	VEHICLE SPEED SENSOR, MASS AIR FLOW SENSOR(DSL), ECM(DSL), SEMI ACTIVE CONTROL MODULE(GSL), PCM(GSL)
HORN	15A	HORN RELAY	COOLING	10A	CON FAN #1 RELAY, CON FAN #2 RELAY
IG COIL	20A	IGNITION COIL #1~#6(GSL), CONDENSER(GSL), ECM(DSL)	B/UP LP	10A	INPUT SPEED SENSOR, OUTPUT SPEED SENSOR, TCM(DSL), TRANSAXLE RANGE SWITCH, BACK-UP LAMP SWITCH
SENSOR #3	15A	ECM(DSL), PURGE CONTROL SOLENOID VALVE(GSL), VARIABLE INTAKE MANIFOLD VALVE(GSL), PCM(GSL), OIL CONTROL VALVE(GSL)	ABS	10A	ABS CONTROL MODULE, ESP CONTROL MODULE, YAW RATE SENSOR, 4WD ECM, STOP LAMP SWITCH(GSL), FUSIBLE LINK BOX(DSL), FUEL FILTER WARNING SWITCH(DSL), CLUTCH SWITCH(GSL), MULTIPURPOSE CHECK CONNECTOR
RAD FAN	40A	RAD FAN RELAY	TAIL LH	10A	REAR COMBINATION LAMP LH, POSITION LAMP LH
CON FAN	30A	CON FAN #1 RELAY, CON FAN #2 RELAY	TAIL RH	10A	REAR COMBINATION LAMP RH, POSITION LAMP RH, GLOVE BOX LAMP, ICM RELAY BOX
SENSOR #2	15A	MASS AIR FLOW SENSOR(GSL), OXYGEN SENSOR #1~#4(GSL), EGR ACTUATOR(DSL), BOOST PRESSURE ACTUATOR(DSL), CAM SHAFT POSITION SENSOR(DSL), FUSIBLE LINK BOX(DSL), THROTTLE FLAP ACTUATOR(DSL), PCM(GSL)	FR FOG	10A	FR FOG RELAY
SENSOR #1	10A	IMMOBILIZER MODULE, INJECTOR #1~#6(GSL), PCM(GSL) STOP LAMP SWITCH(DSL), A/CON RELAY, FUEL PUMP RELAY	SPARE	10A	-
FUEL PUMP	15A	FUEL PUMP RELAY	SPARE	15A	-
H/LP LO LH	15A	H/LP LO LH RELAY	SPARE	20A	-
H/LP LO RH	15A	H/LP LO RH RELAY	SPARE	25A	-
			SPARE	30A	-

※ USE THE DESIGNATED FUSE ONLY

FUSIBLE LINK BOX

DIESEL

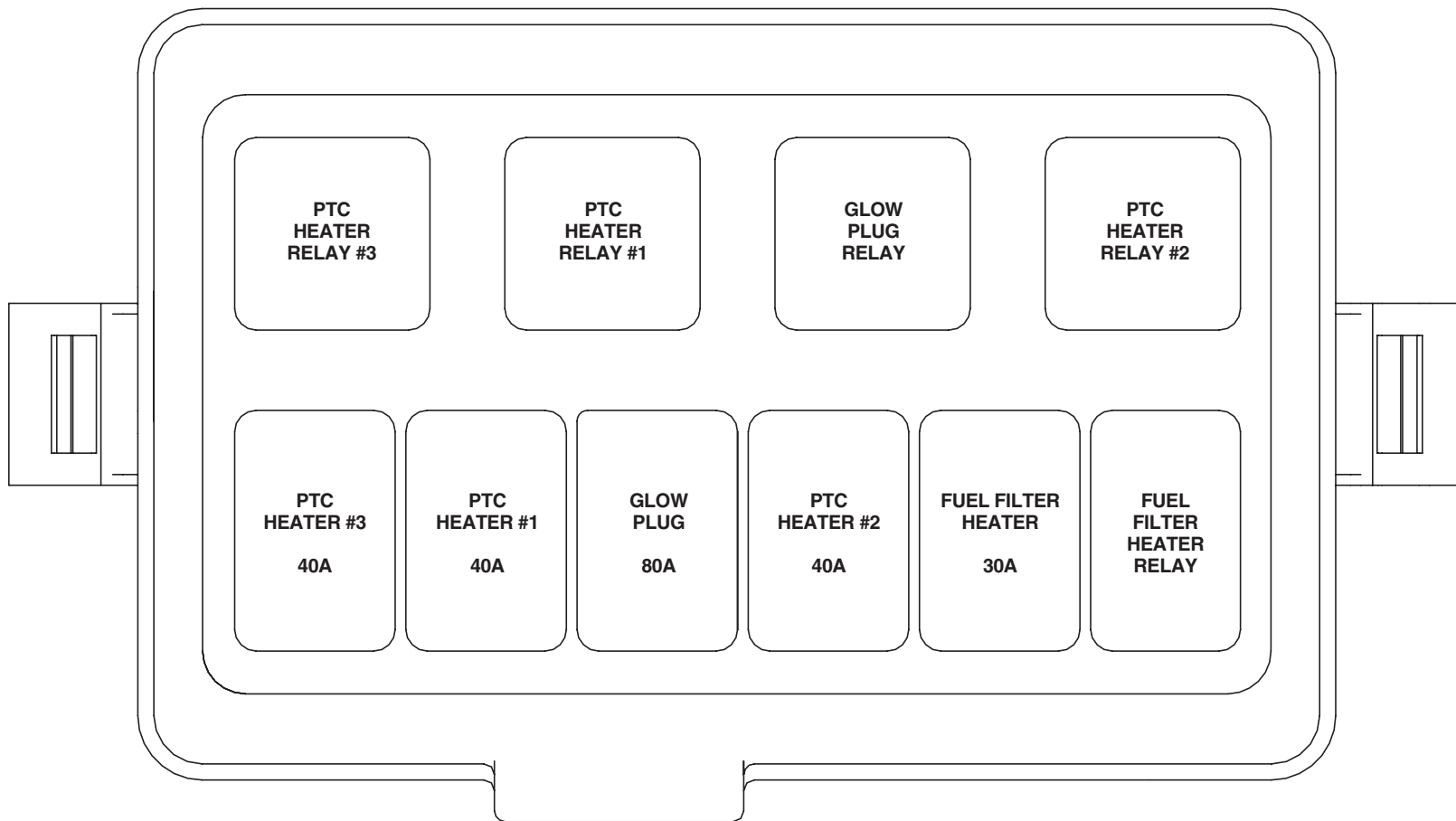

※ USE THE DESIGNATED FUSE ONLY

FUSE & RELAY INFORMATIONS

FUSE & RELAY INFORMATIONS (6)

SD100-6

ICM RELAY BOX

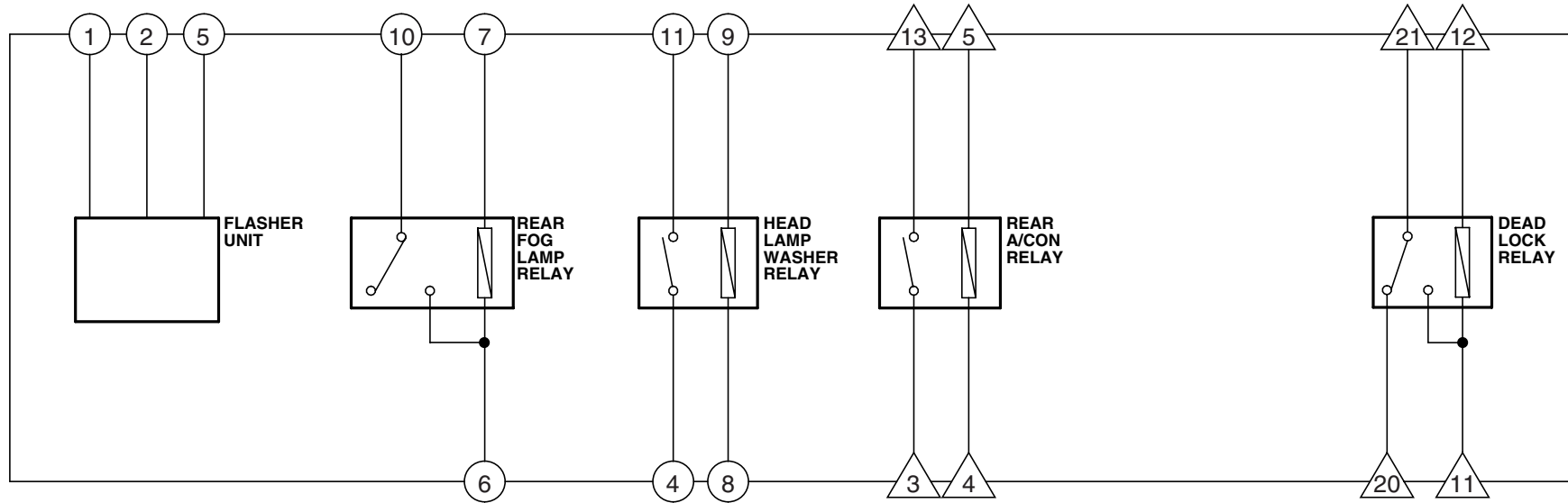

ICM-A(O)

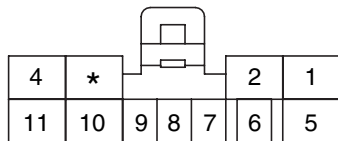

KET_1809_11F_W_UNIT

ICM-B(△)

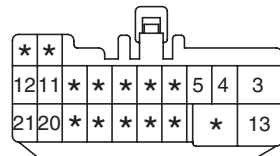

KET_1809_21F_W_A

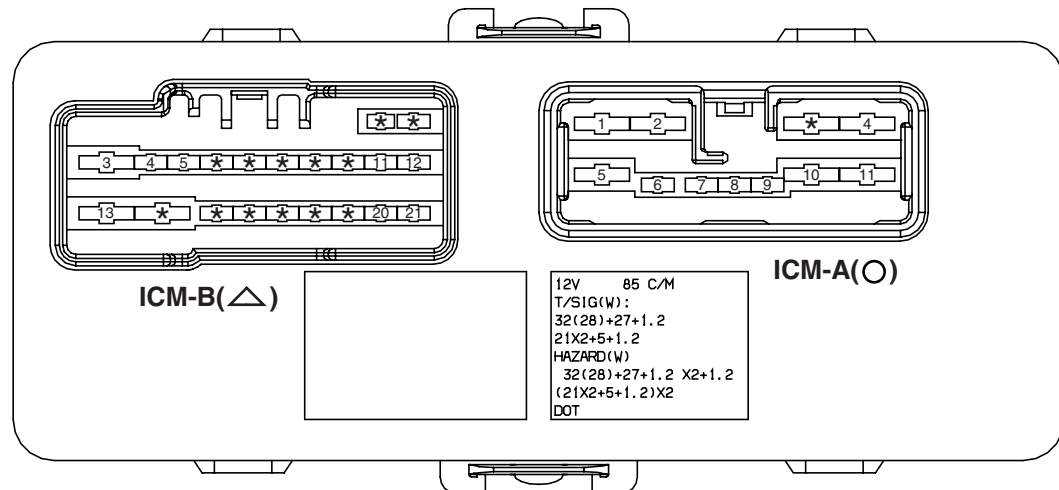

ICM-B(△)

ICM-A(O)

12V 85 C/M
 T/SIG(W):
 32(28)+27+1.2
 21X2+5+1.2
 HAZARD(W)
 32(28)+27+1.2 X2+1.2
 (21X2+5+1.2)X2
 DOT

POWER DISTRIBUTION (1)

SD110-1

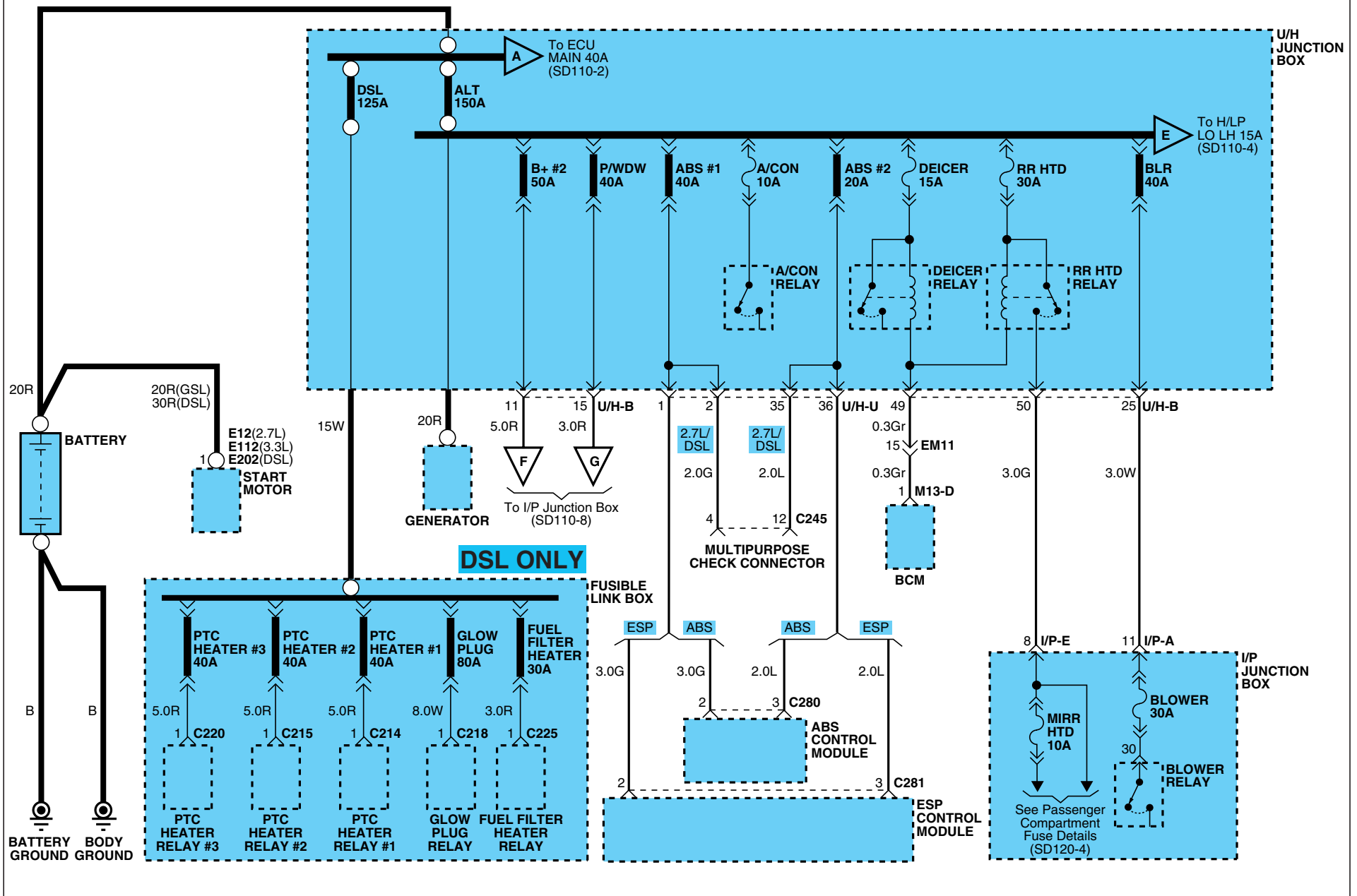

POWER DISTRIBUTION

POWER DISTRIBUTION (2)

SD110-2

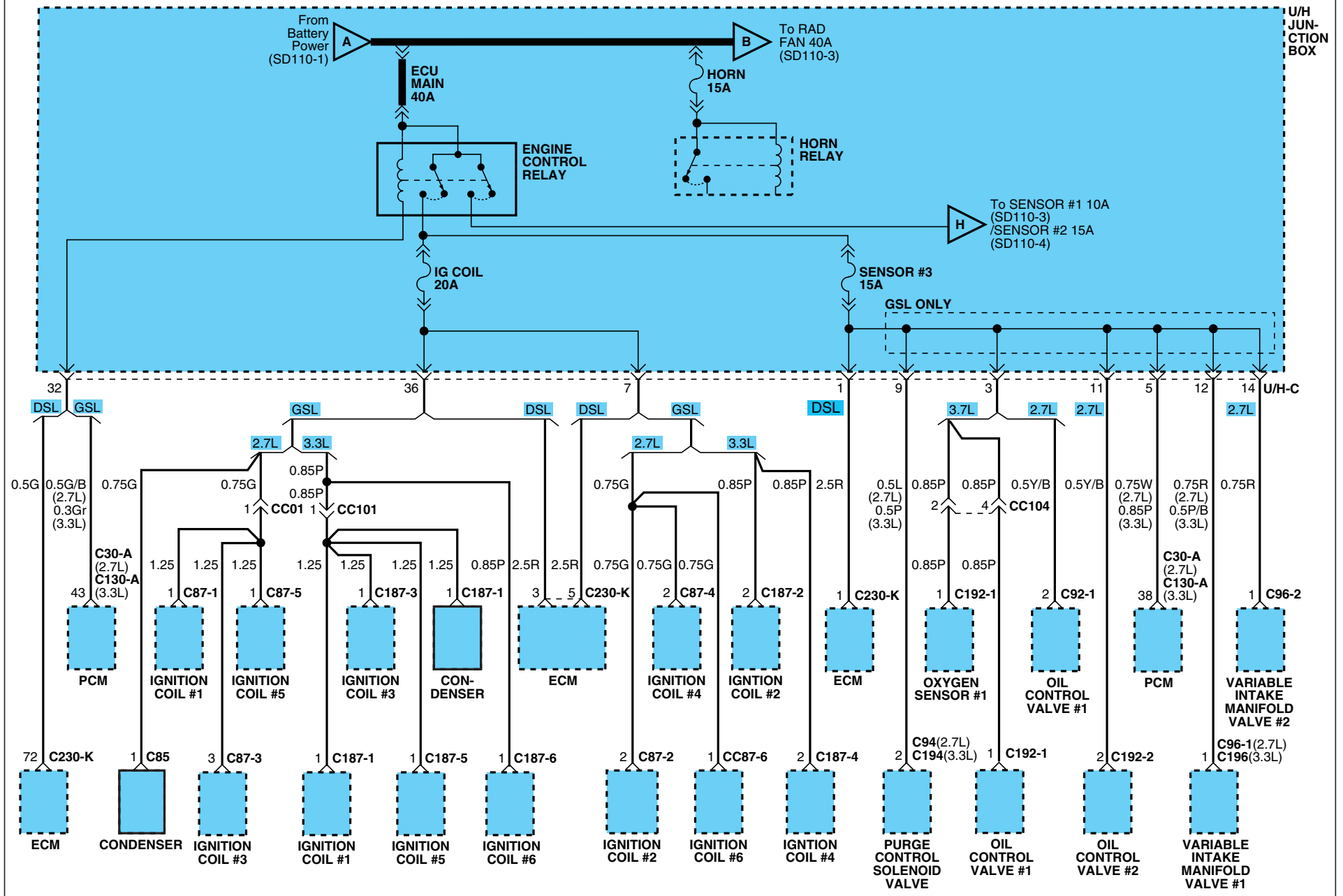

POWER DISTRIBUTION

POWER DISTRIBUTION (3)

SD110-3

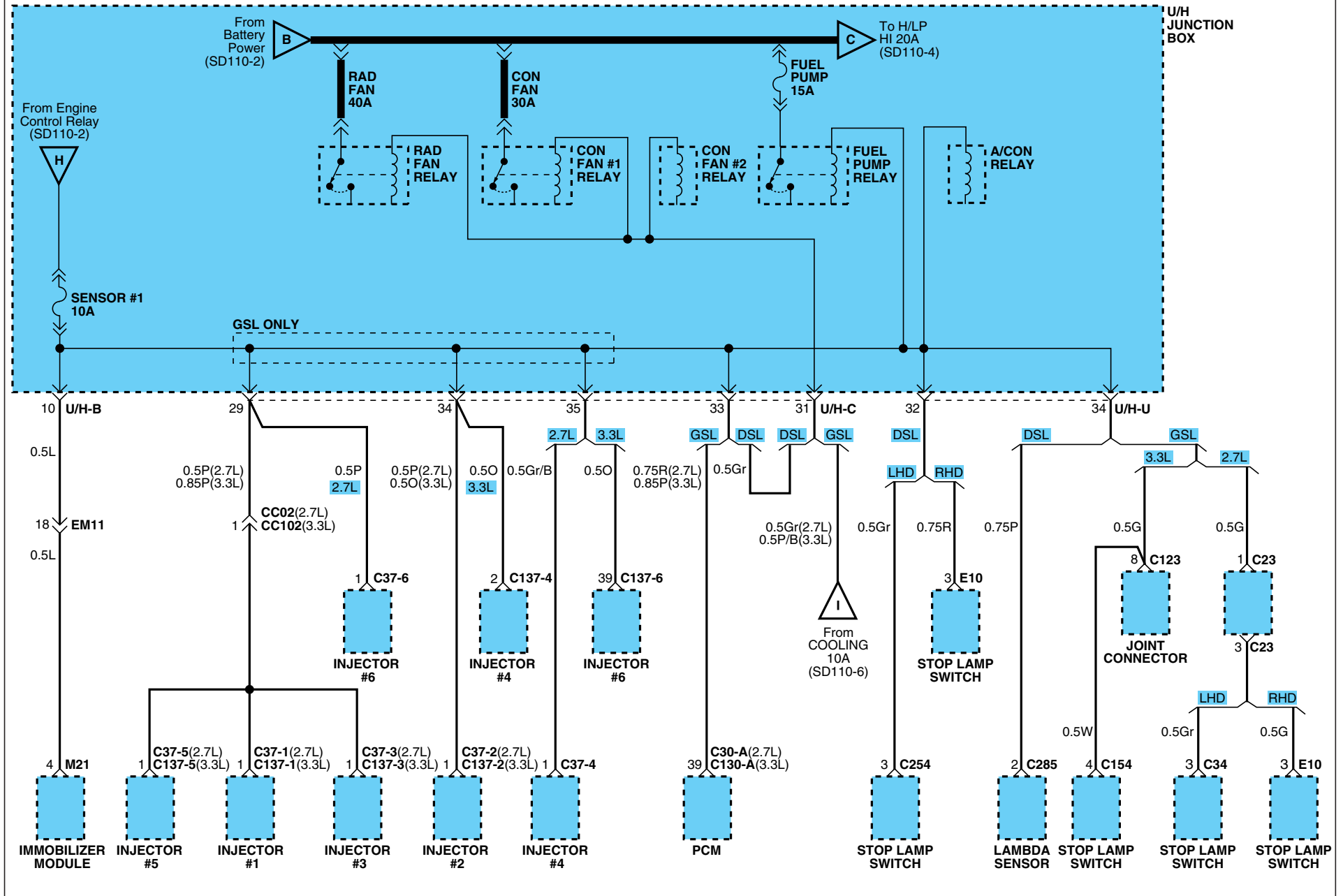

POWER DISTRIBUTION

POWER DISTRIBUTION (4)

SD110-4

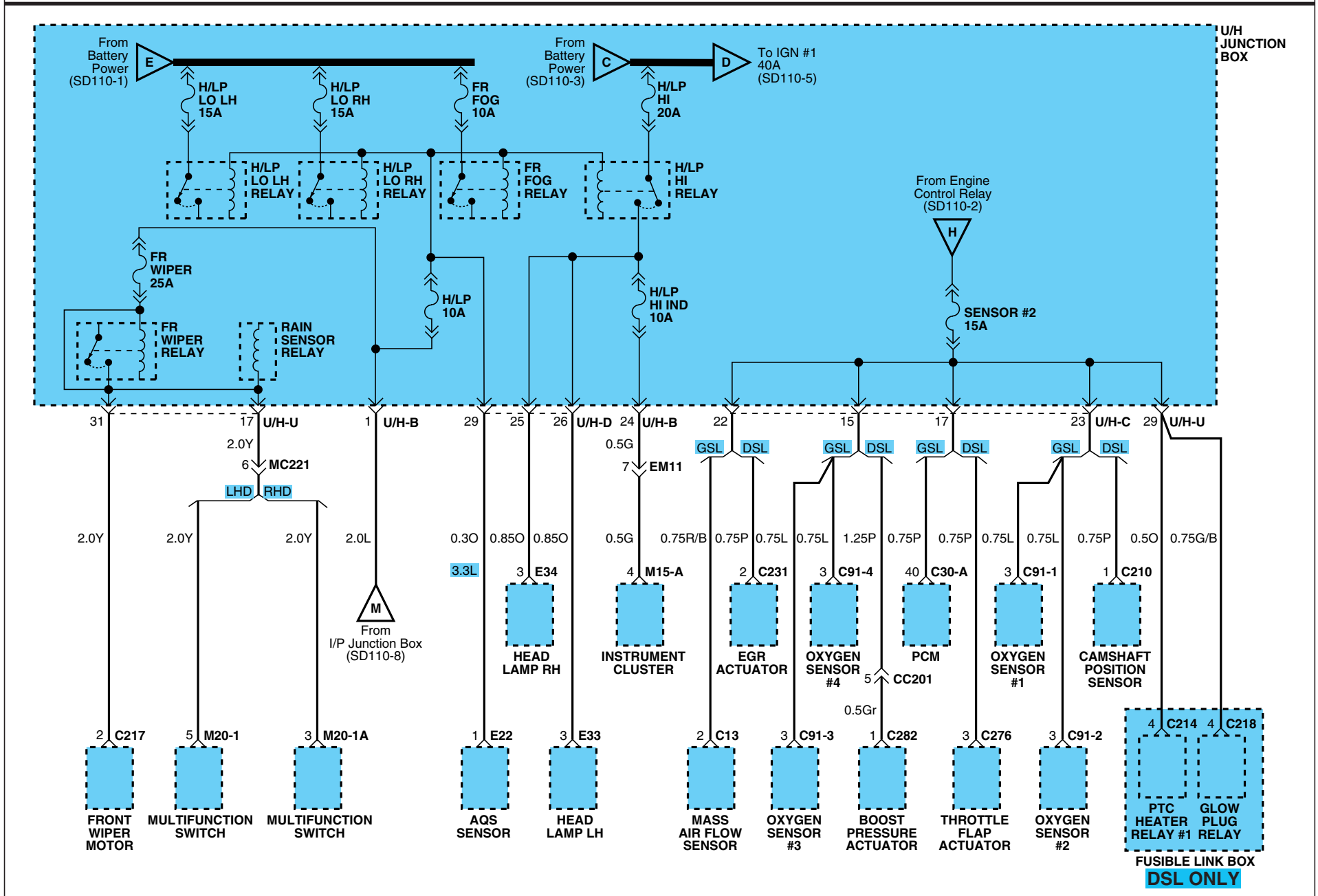

POWER DISTRIBUTION

POWER DISTRIBUTION (5)

SD110-5

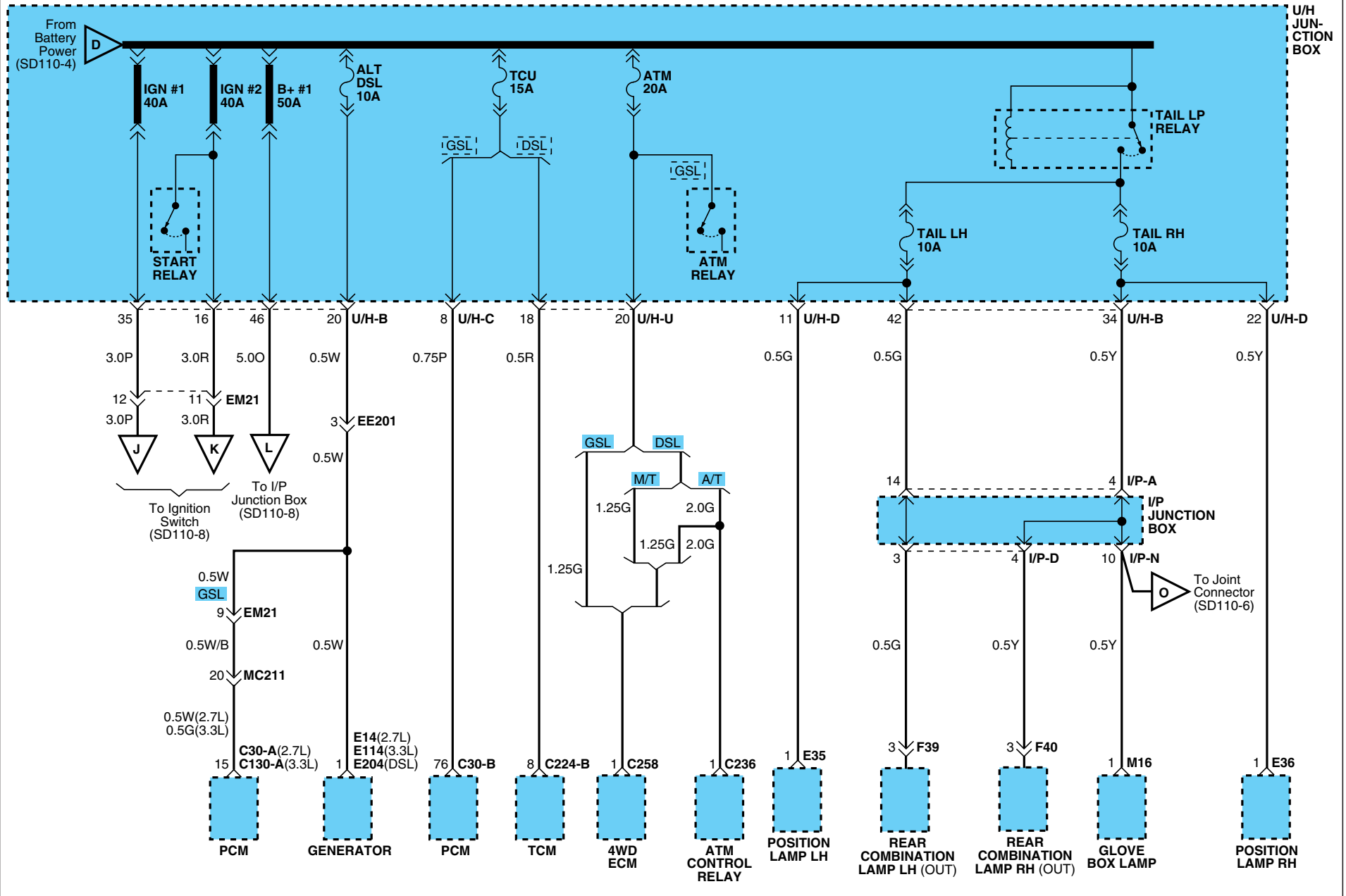

POWER DISTRIBUTION

POWER DISTRIBUTION (6)

SD110-6

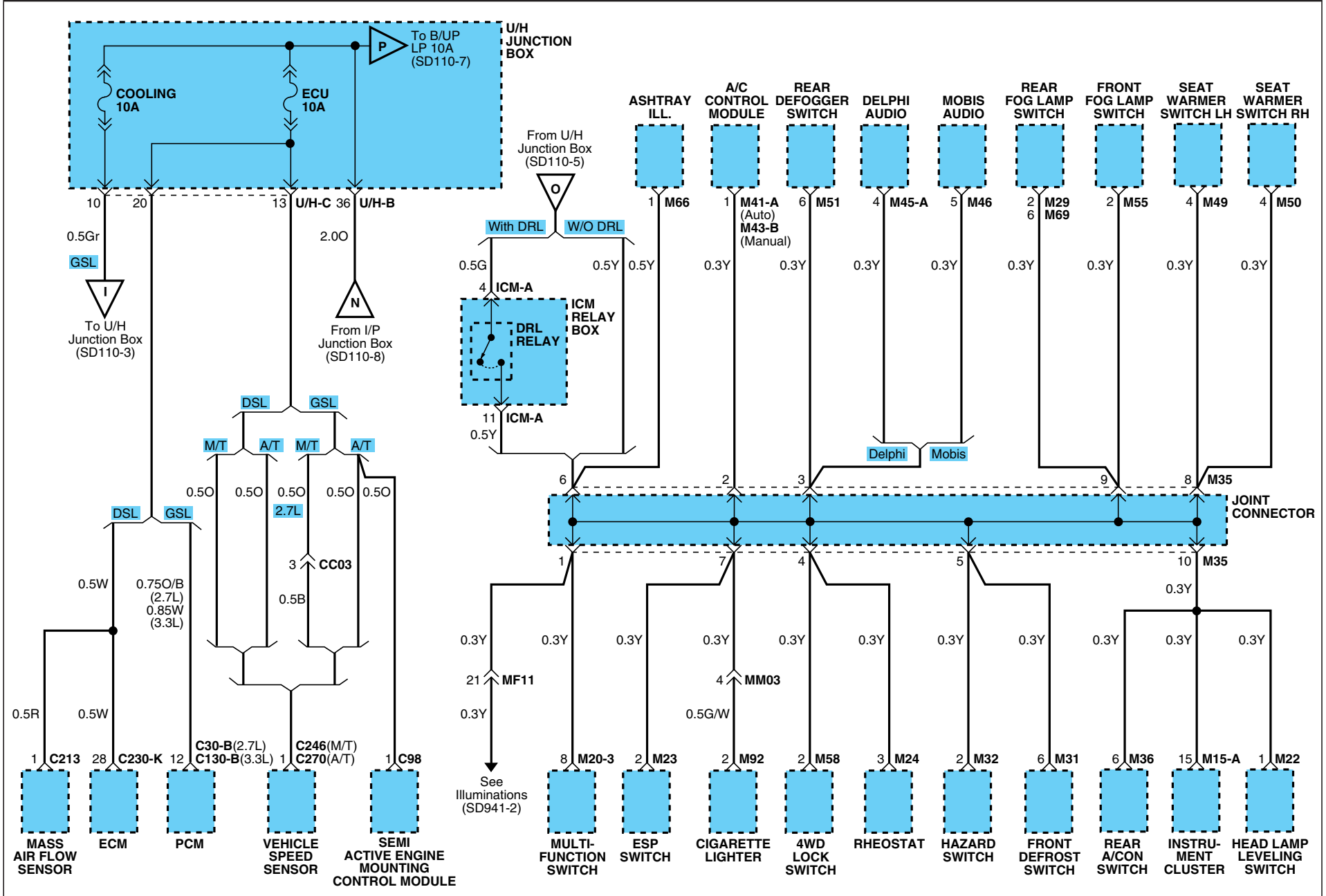

POWER DISTRIBUTION

POWER DISTRIBUTION (7)

SD110-7

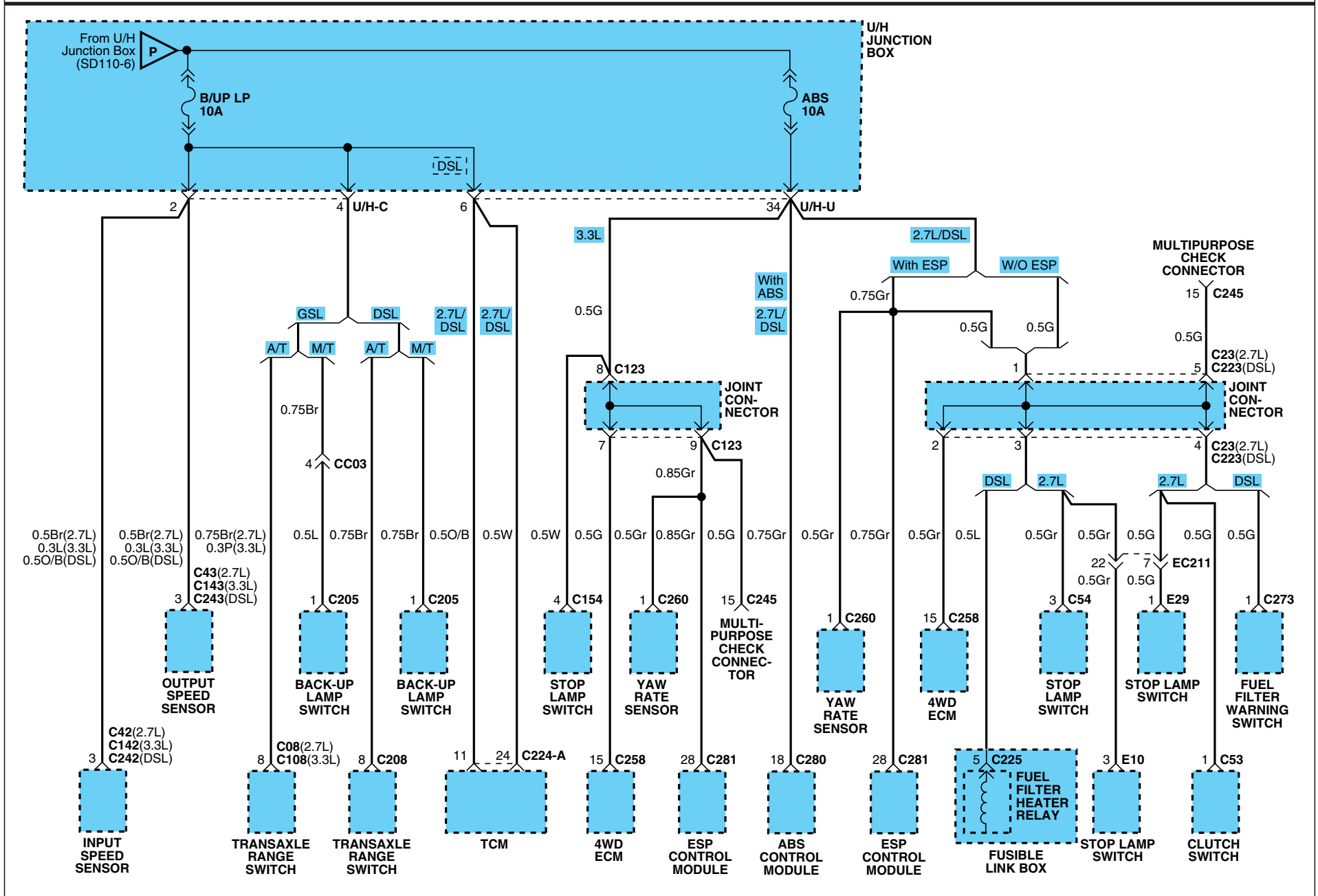

POWER DISTRIBUTION

POWER DISTRIBUTION (8)

SD110-8

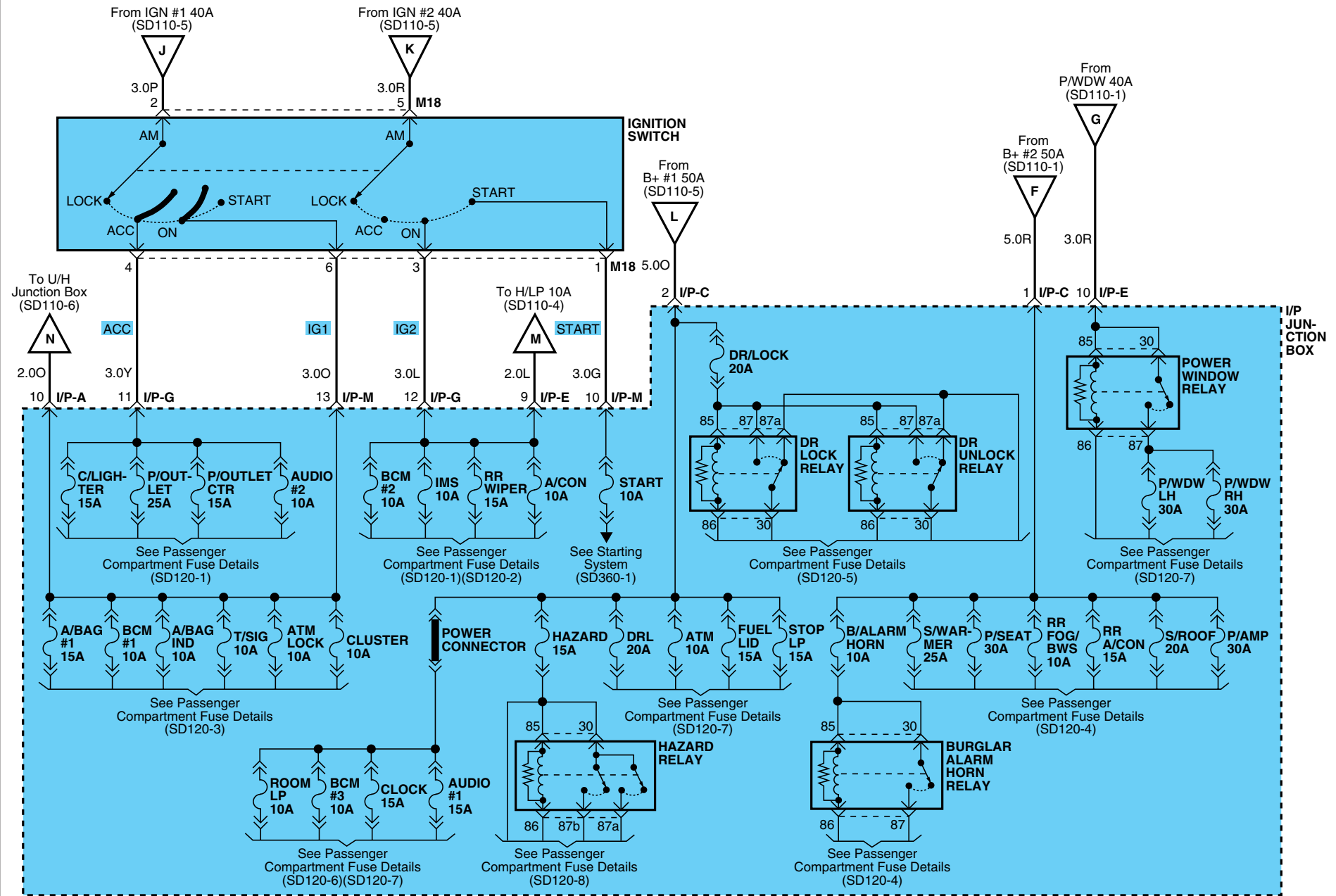

PASSENGER COMPARTMENT FUSE DETAILS EDDAB1EA

PASSENGER COMPARTMENT FUSE DETAILS (1)

SD120-1

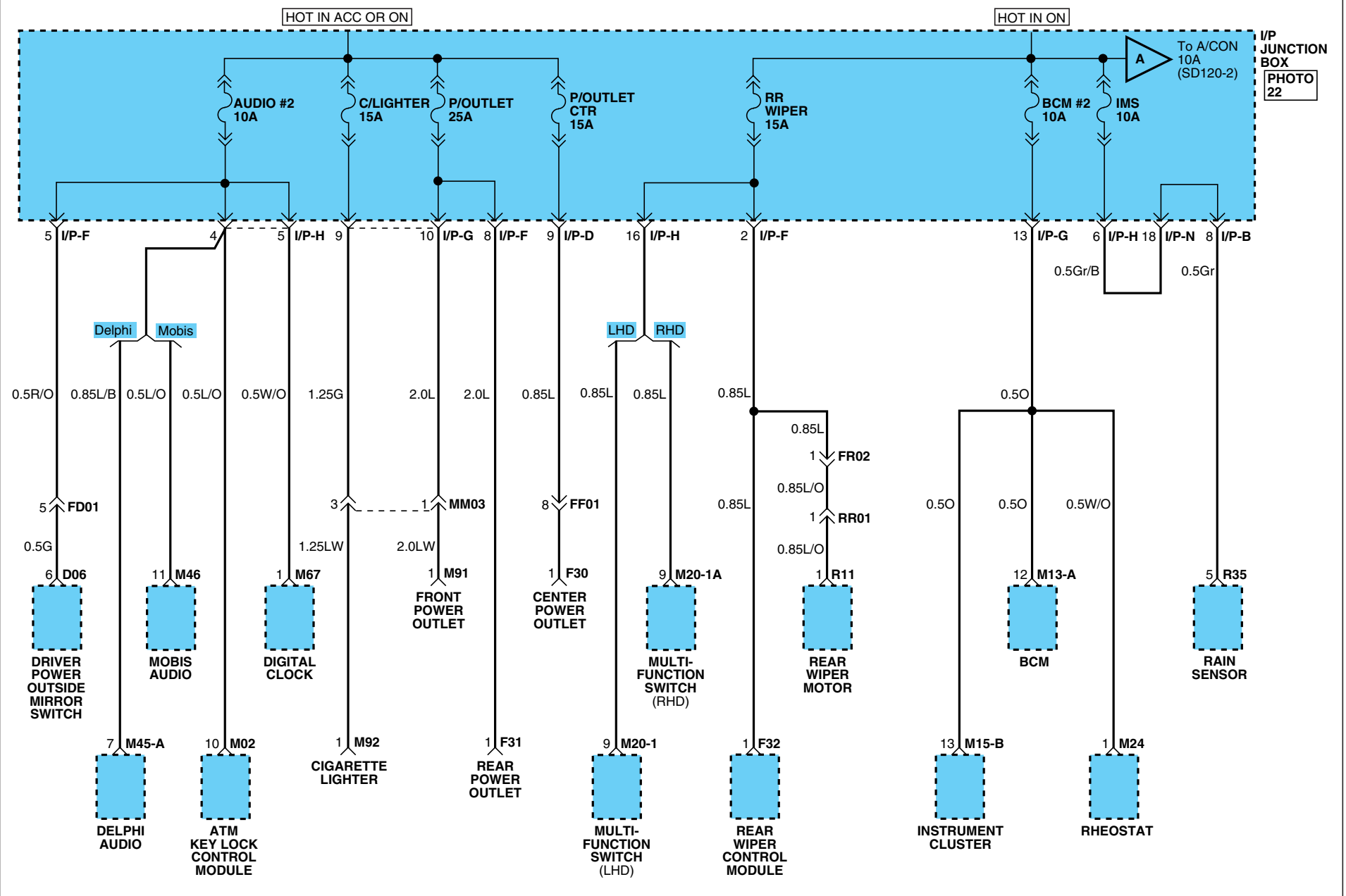

PASSENGER COMPARTMENT FUSE DETAILS

PASSENGER COMPARTMENT FUSE DETAILS (2)

SD120-2

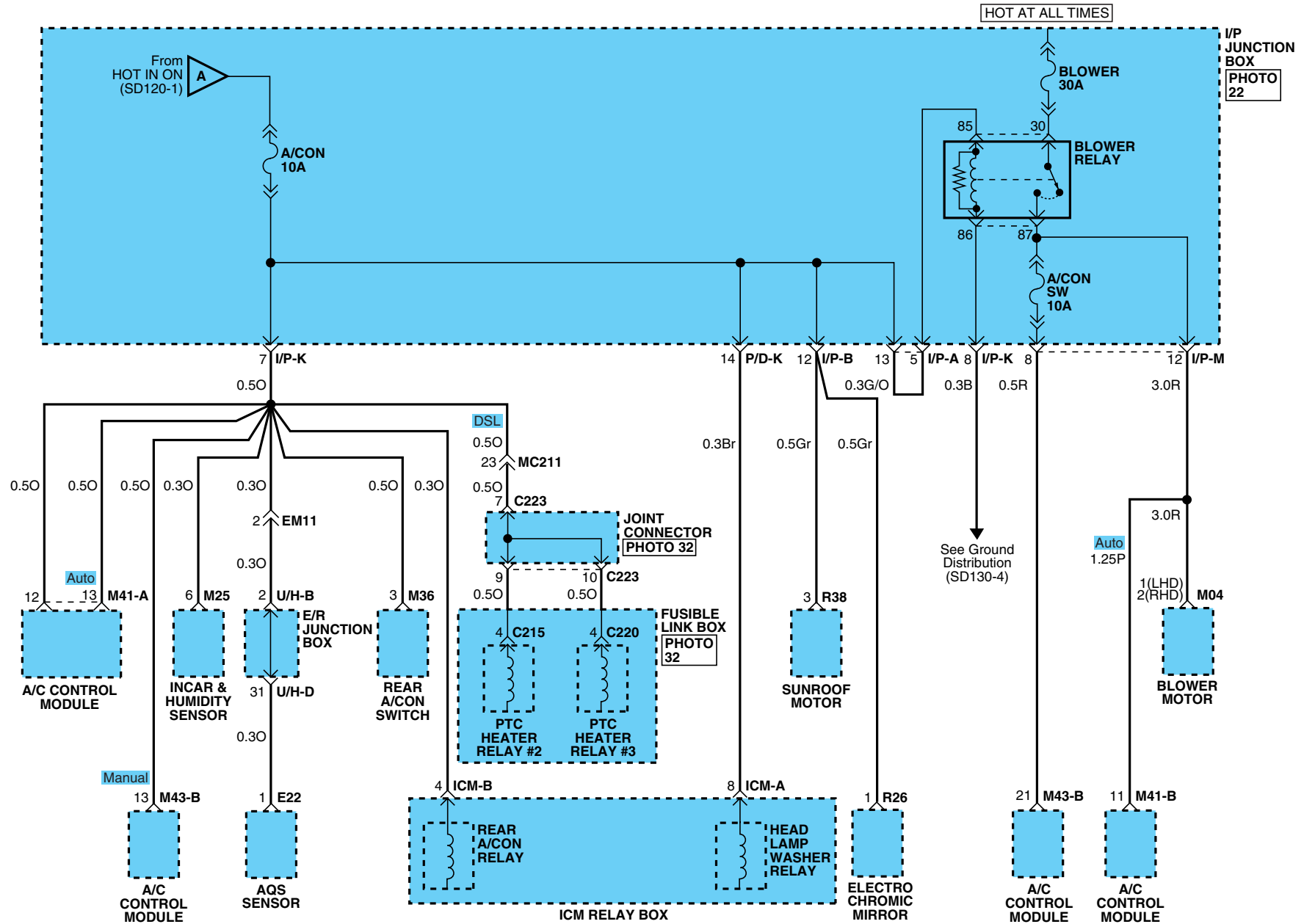

PASSENGER COMPARTMENT FUSE DETAILS

PASSENGER COMPARTMENT FUSE DETAILS (3)

SD120-3

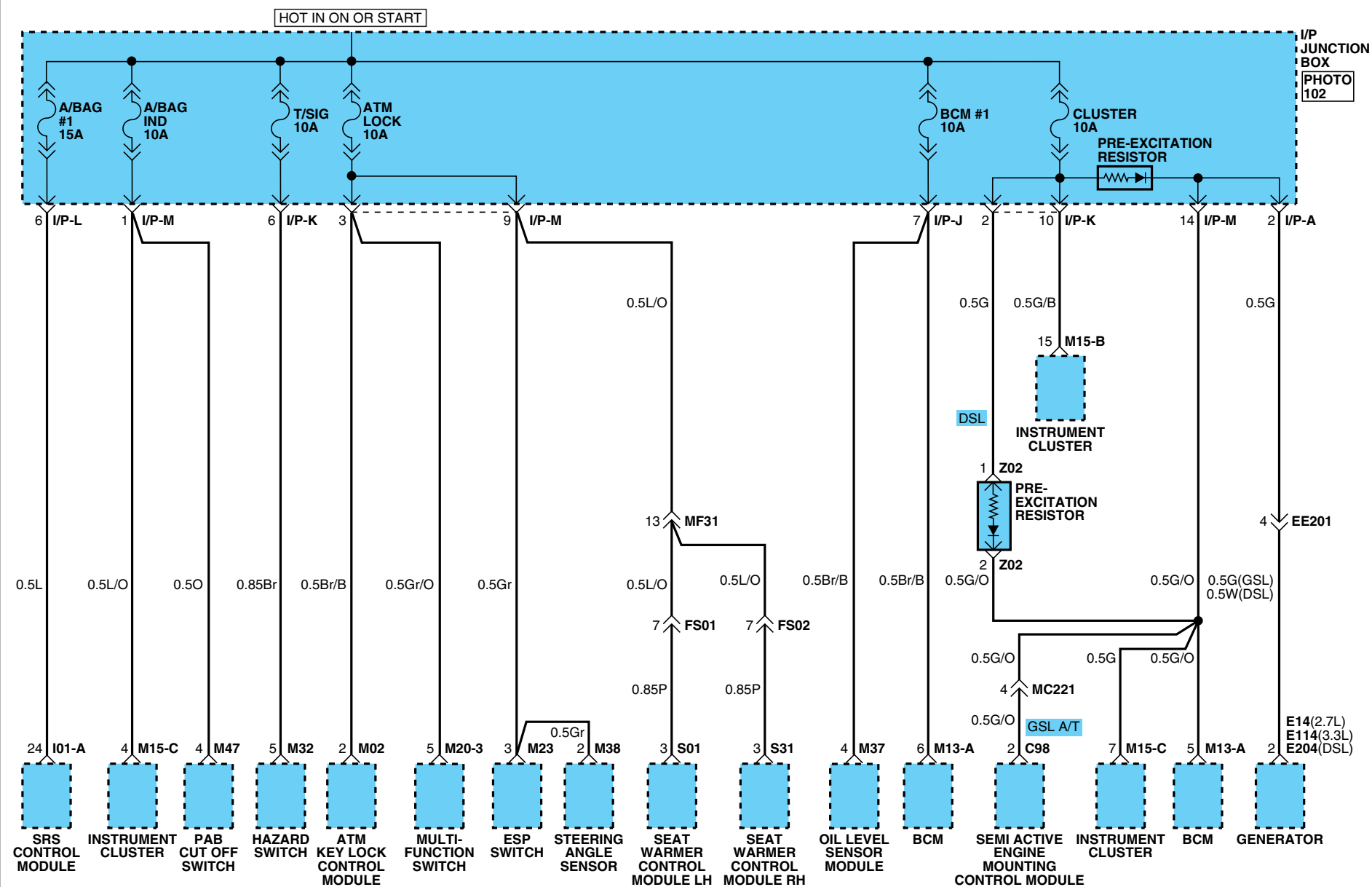

PASSENGER COMPARTMENT FUSE DETAILS

PASSENGER COMPARTMENT FUSE DETAILS (4)

SD120-4

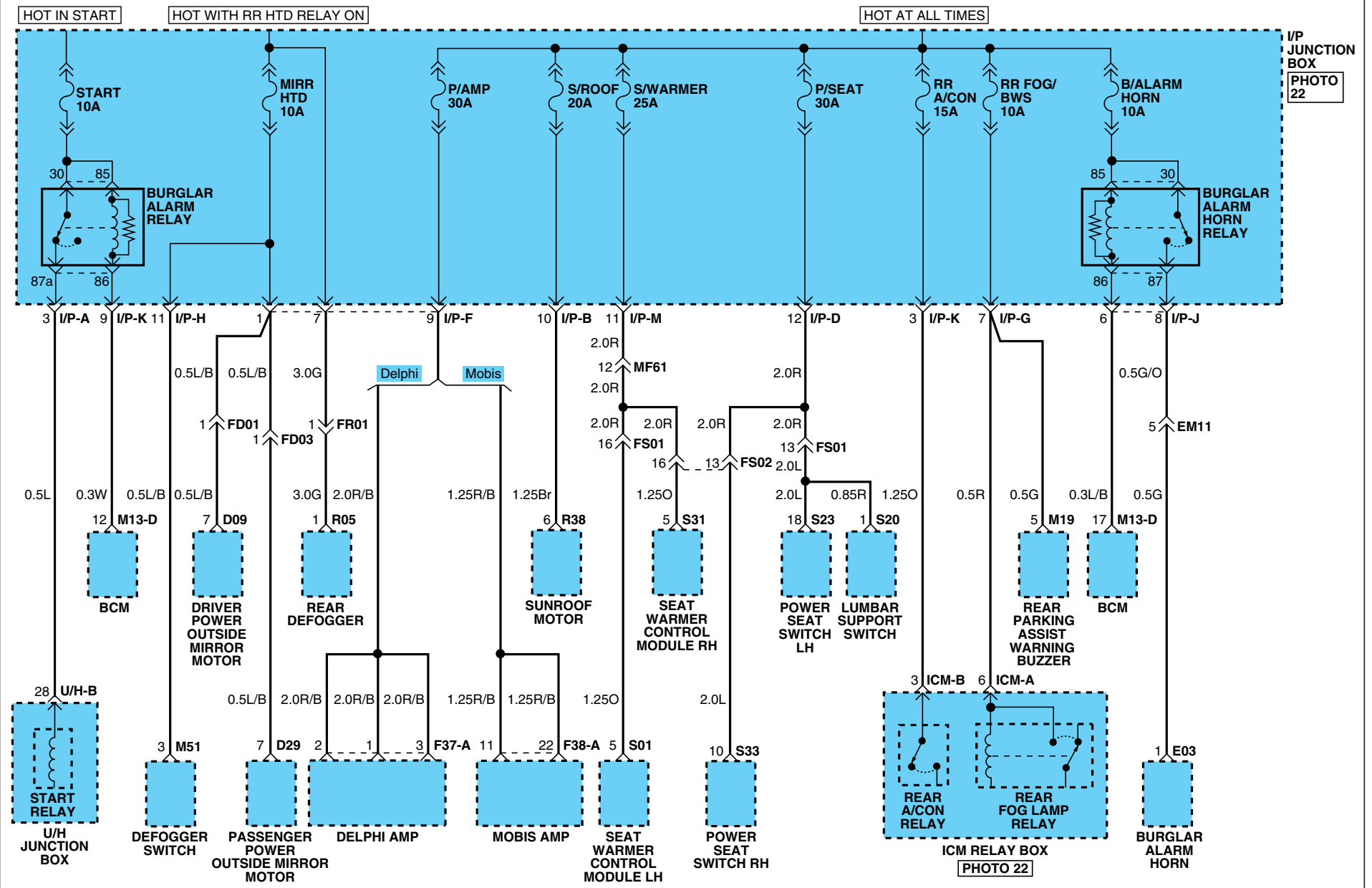

PASSENGER COMPARTMENT FUSE DETAILS

PASSENGER COMPARTMENT FUSE DETAILS (5)

SD120-5

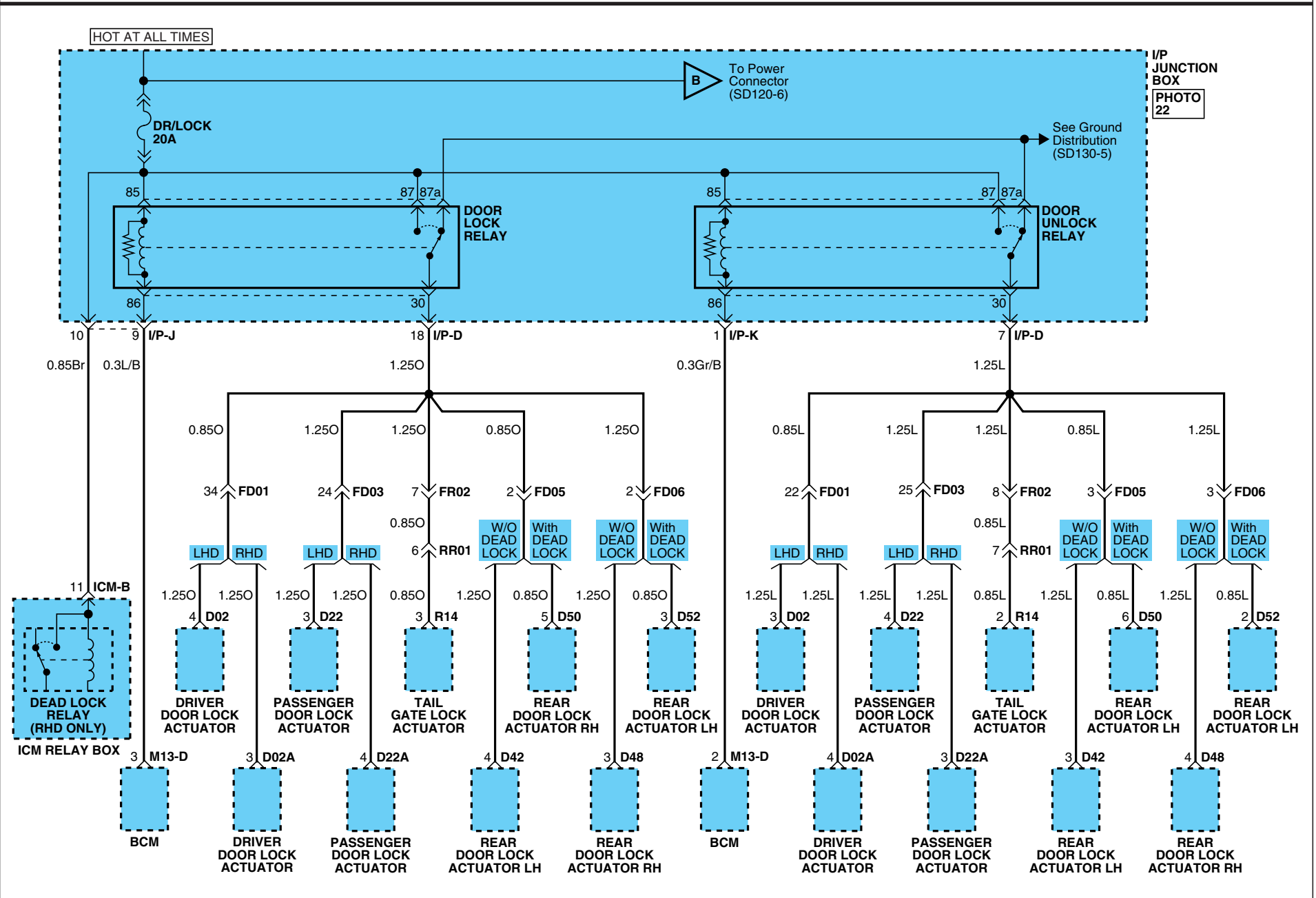

PASSENGER COMPARTMENT FUSE DETAILS

PASSENGER COMPARTMENT FUSE DETAILS (6)

SD120-6

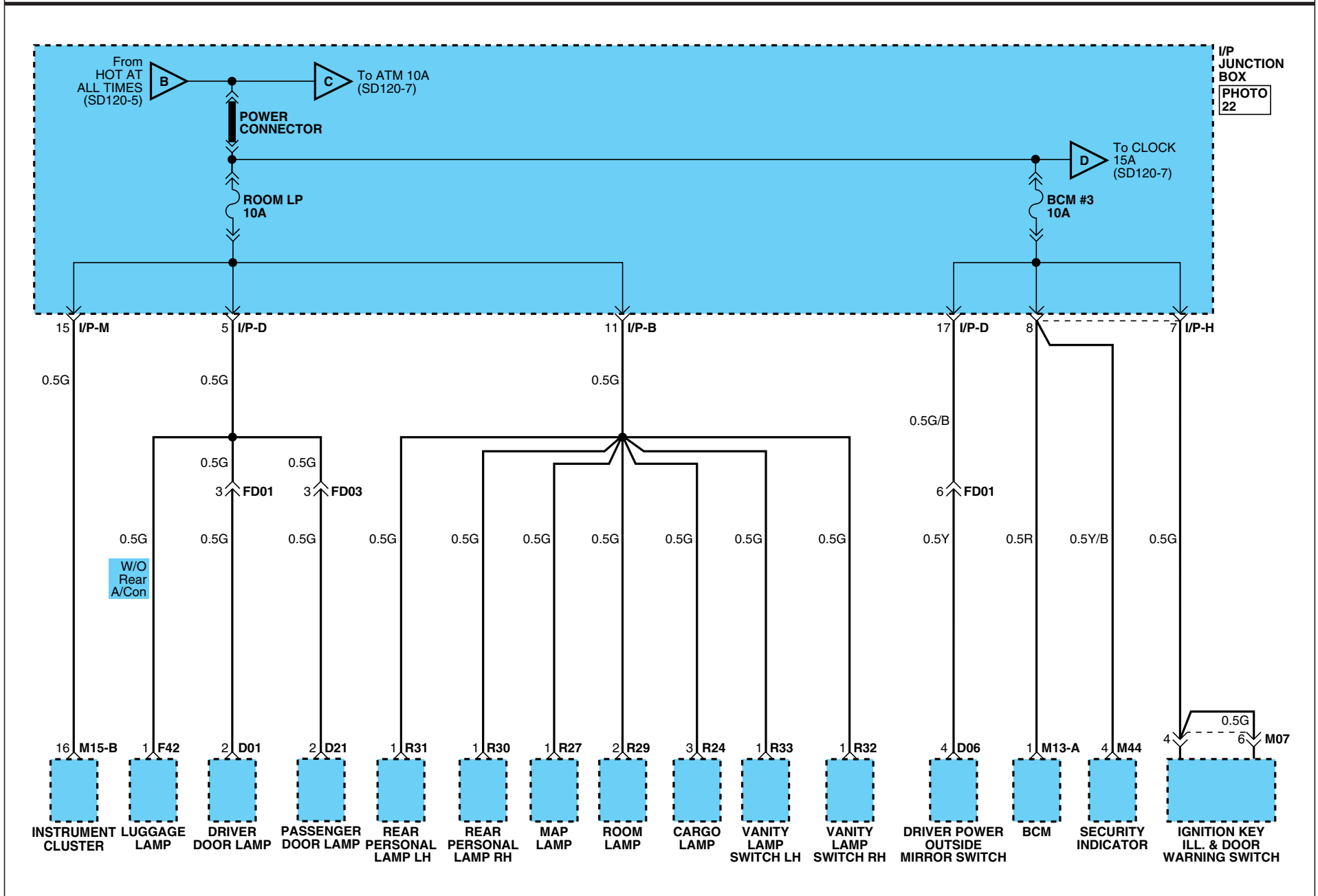

PASSENGER COMPARTMENT FUSE DETAILS

PASSENGER COMPARTMENT FUSE DETAILS (7)

SD120-7

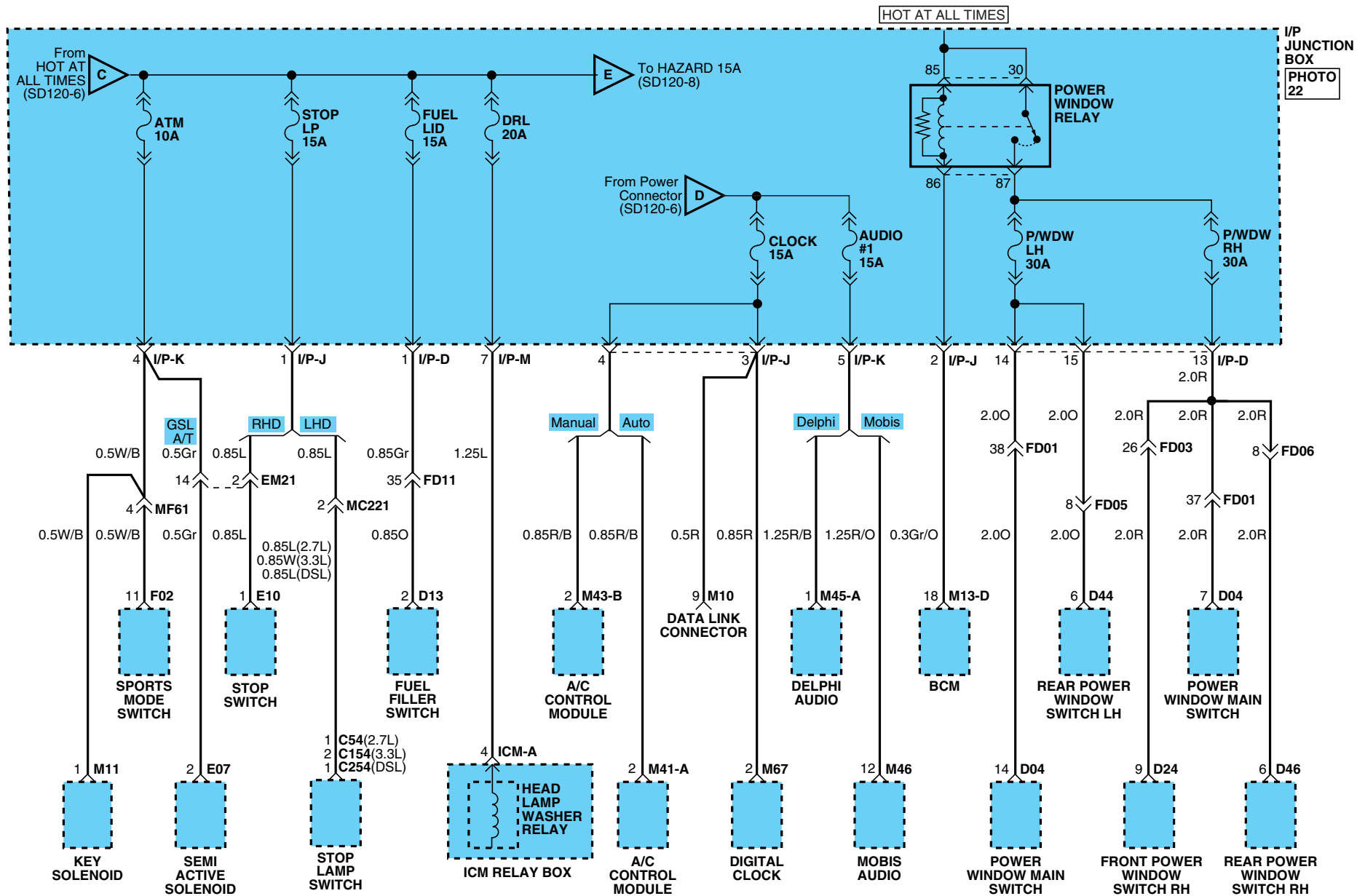

PASSENGER COMPARTMENT FUSE DETAILS

PASSENGER COMPARTMENT FUSE DETAILS (8)

SD120-8

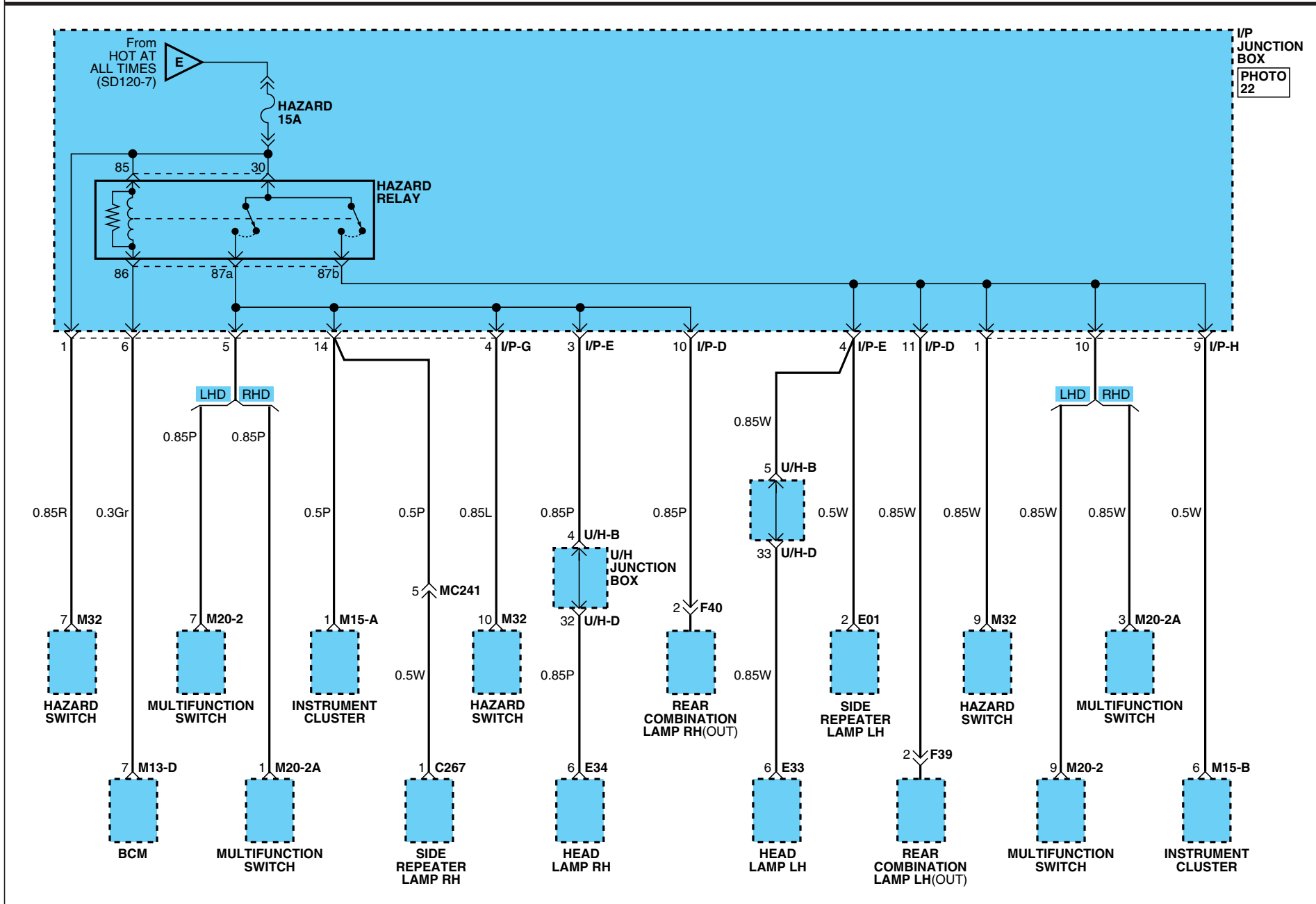

GROUND DISTRIBUTION

GROUND DISTRIBUTION (2)

SD130-2

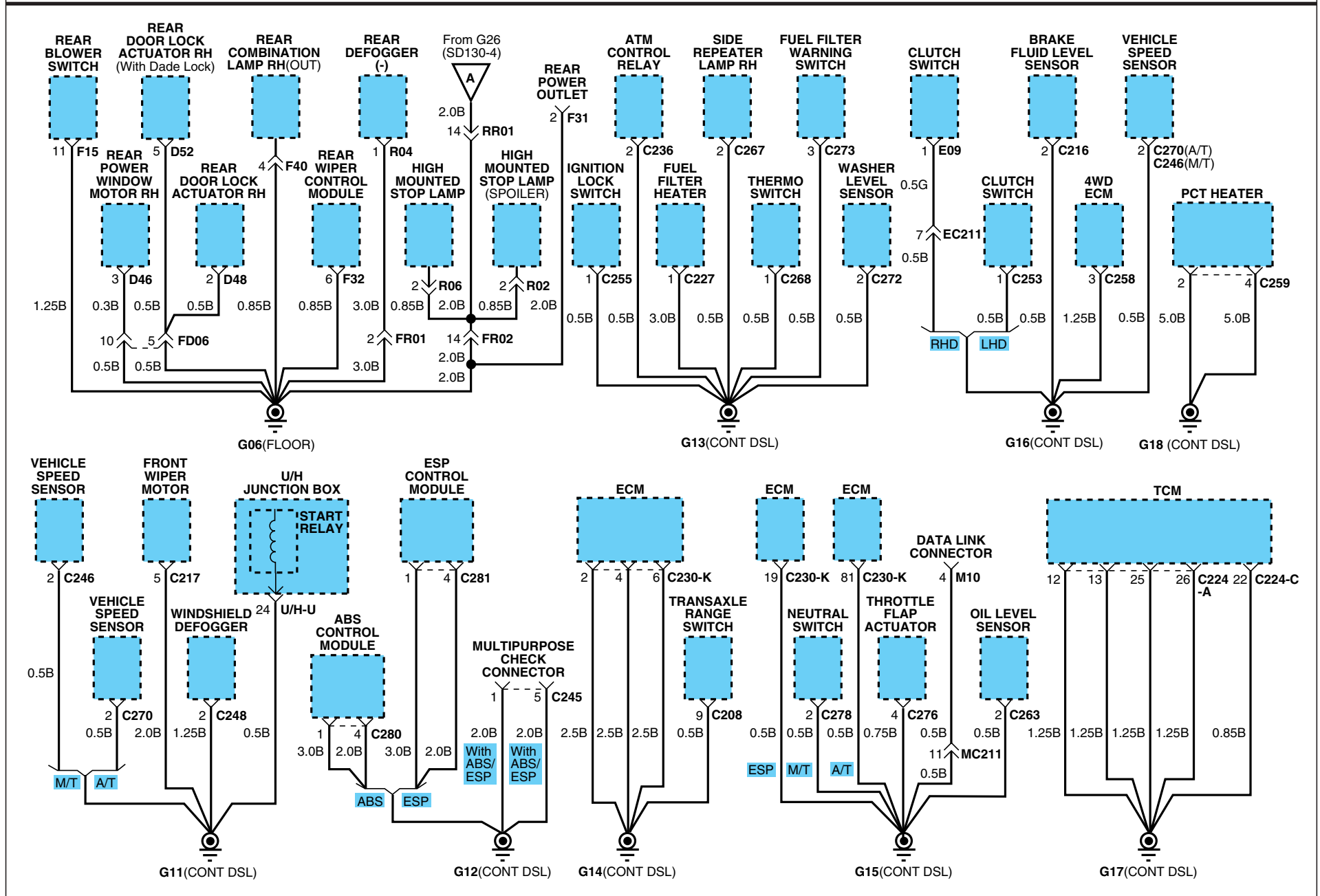

GROUND DISTRIBUTION

GROUND DISTRIBUTION (3)

SD130-3

2.7L

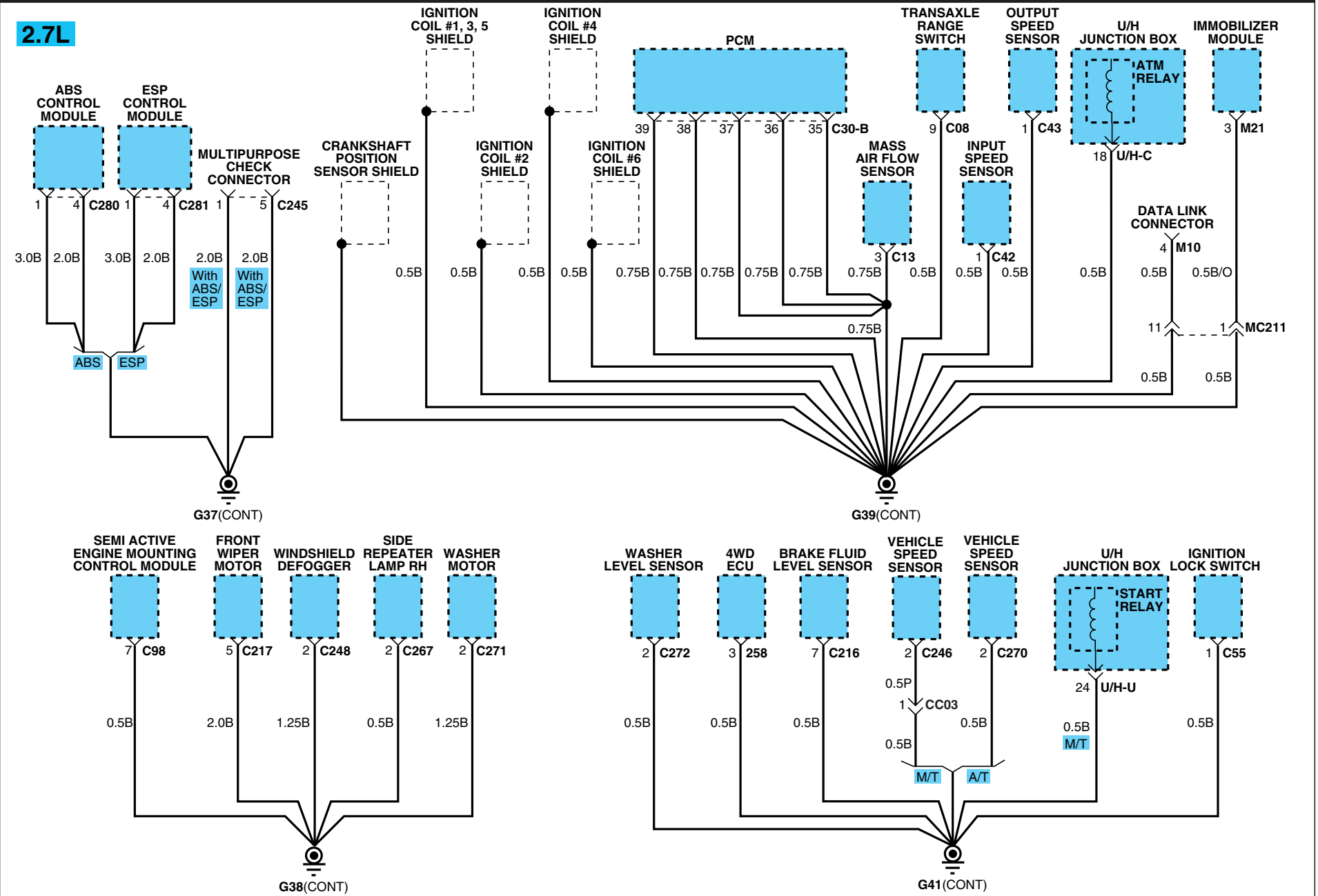

GROUND DISTRIBUTION

GROUND DISTRIBUTION (4)

SD130-4

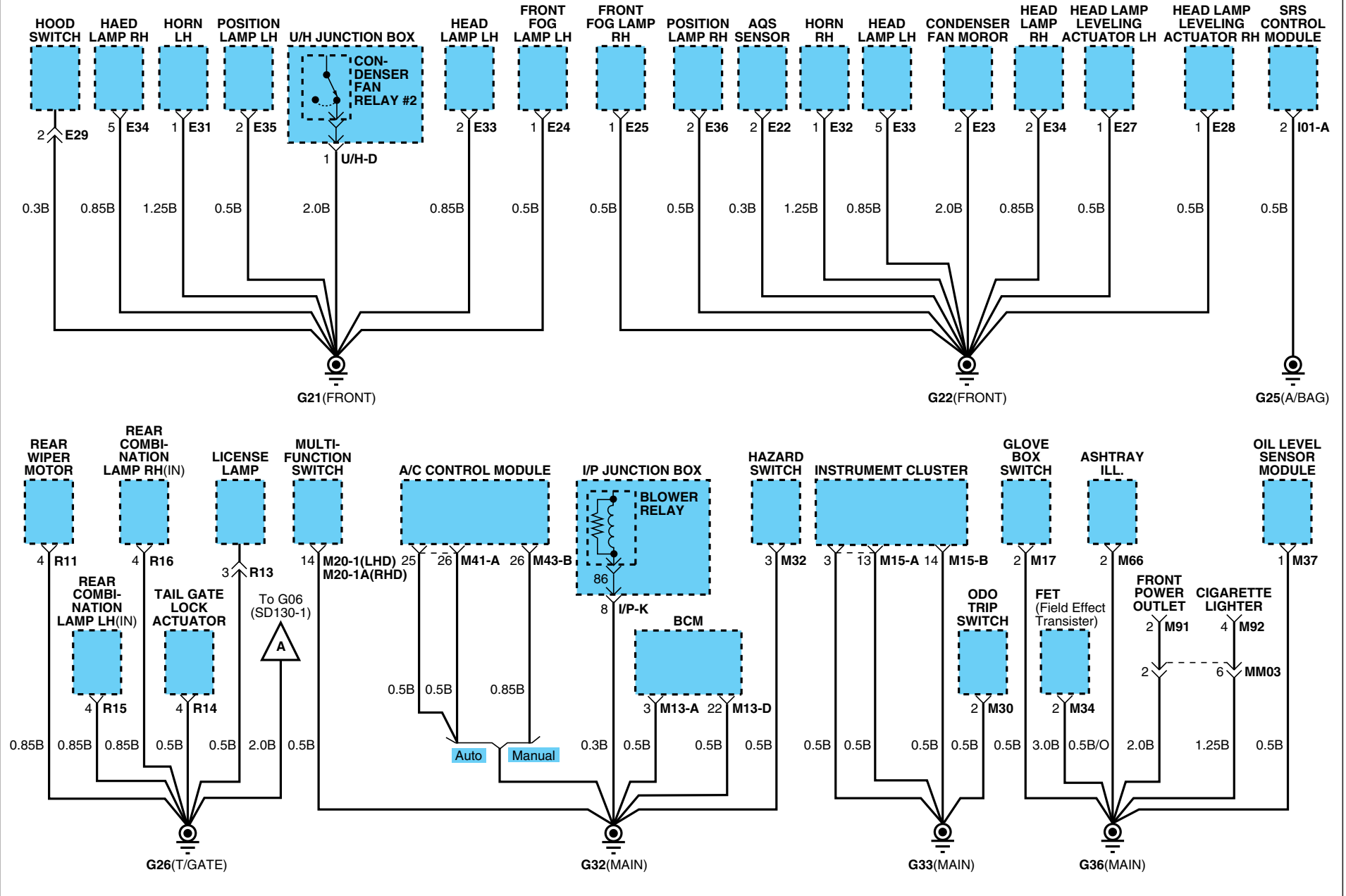

GROUND DISTRIBUTION

GROUND DISTRIBUTION (5)

SD130-5

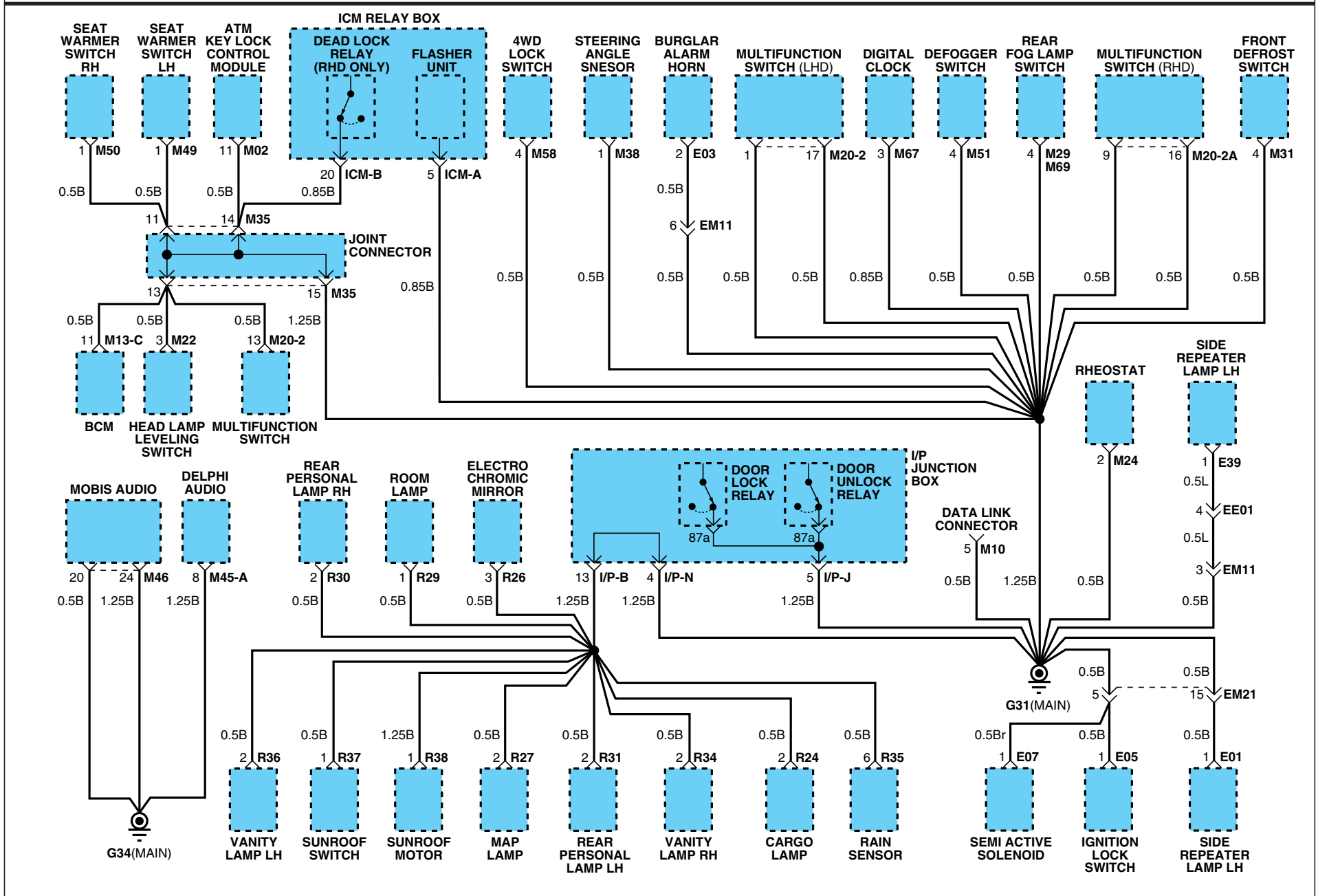

GROUND DISTRIBUTION

GROUND DISTRIBUTION (6)

SD130-6

3.3L

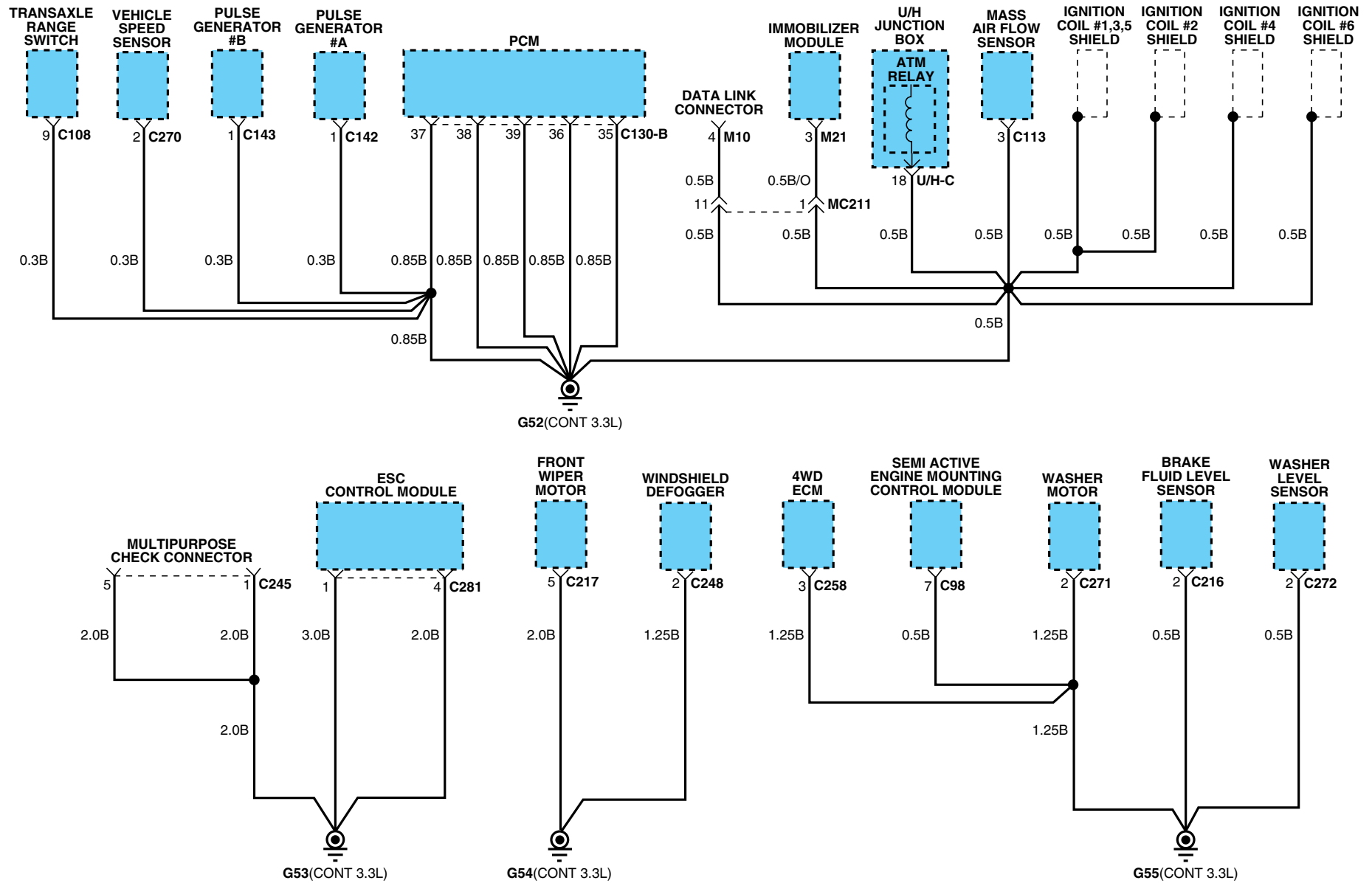

DATA LINK DETAILS

DATA LINK DETAILS (2)

SD200-2

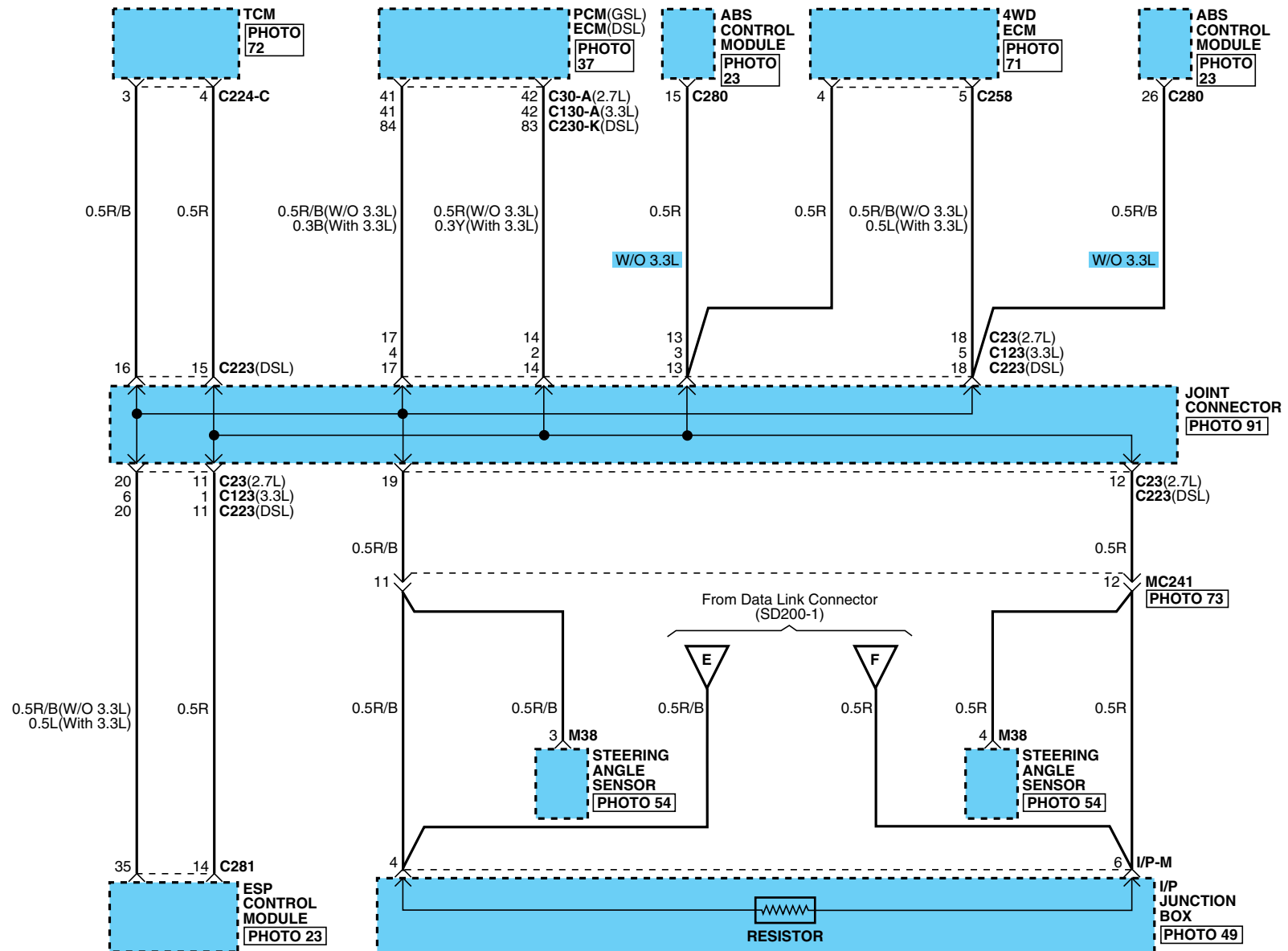

DATA LINK DETAILS

DATA LINK DETAILS (3)

SD200-3

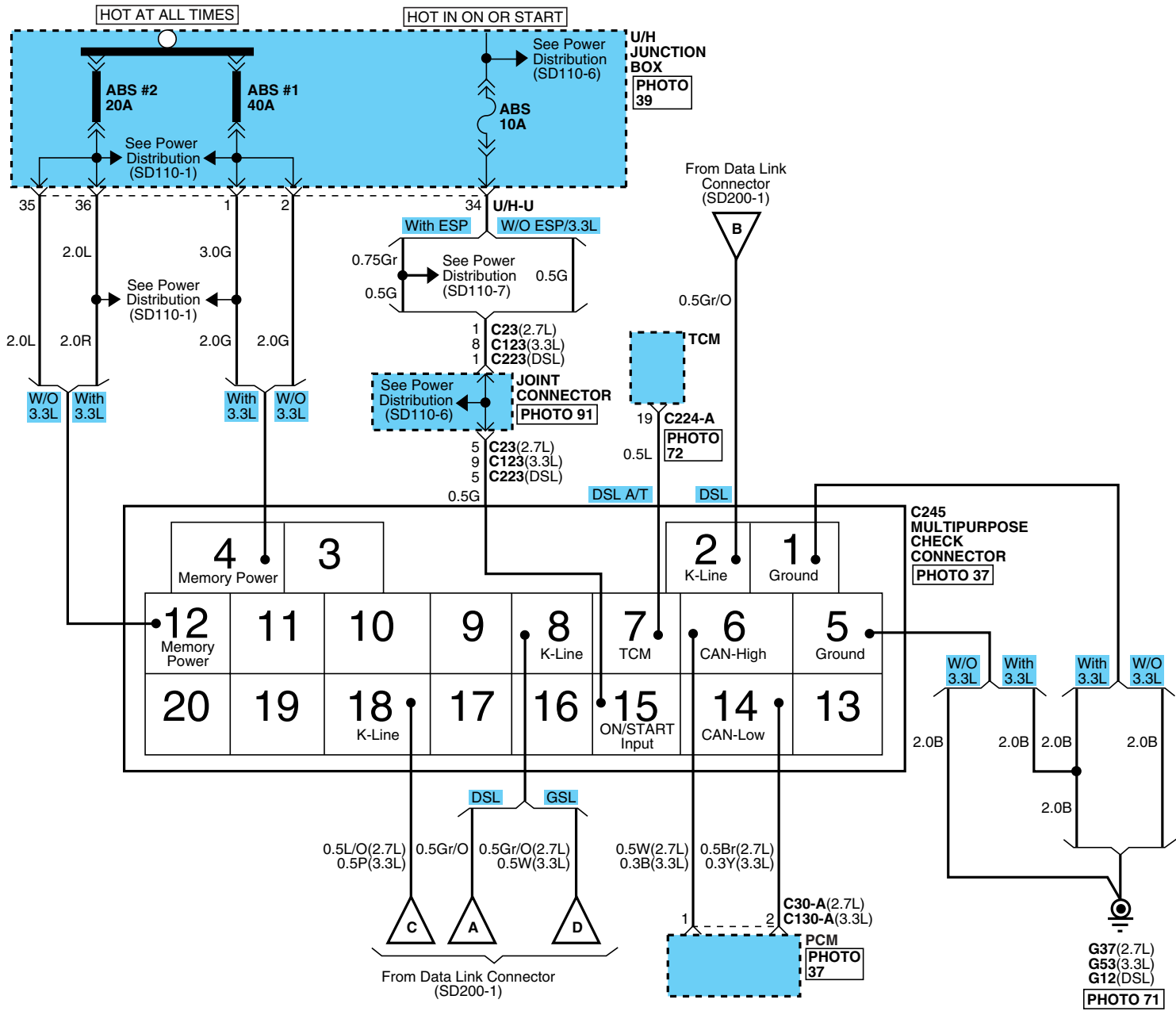

DATA LINK DETAILS

DATA LINK DETAILS (4)

SD200-4

C30-A

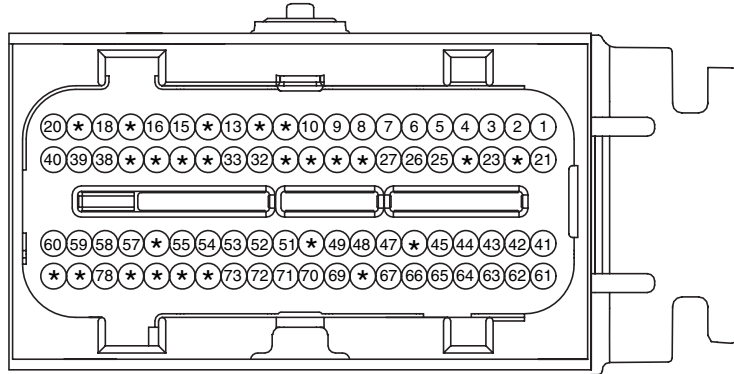

PKD_ECU_80F_Gr_NR

C130-A

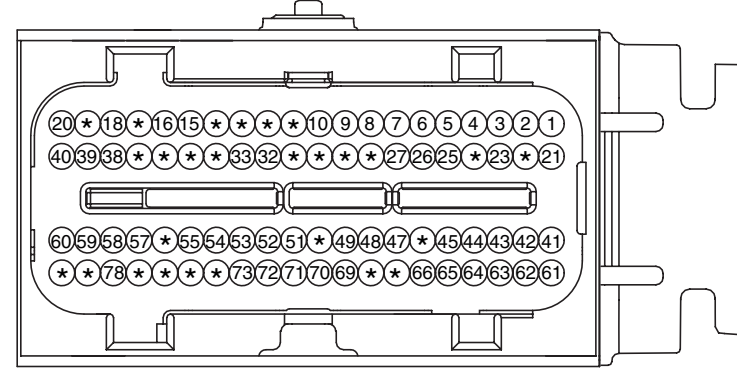

PKD_ECU_80F_Gr_3

C224-A

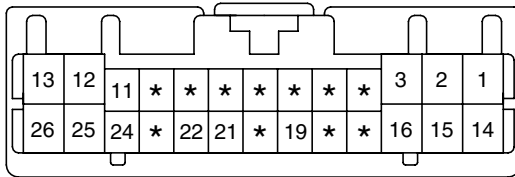

KET_0407_26F_W

C230-K

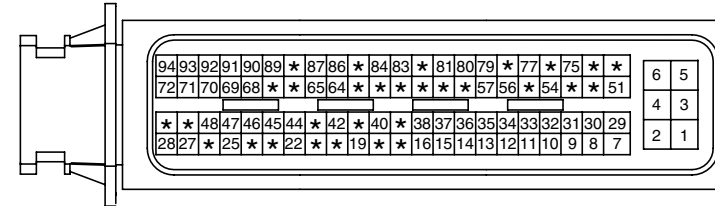

AMP_ECU_94F_B

C245(DSL)

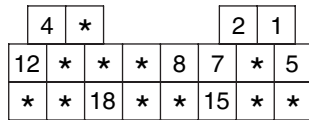

AMP_0407_26F_W_HD

C245(GSL)

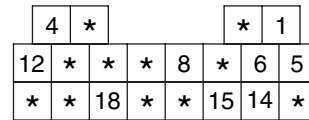

AMP_0407_26F_W_HD

C258(2.7L/DSL)

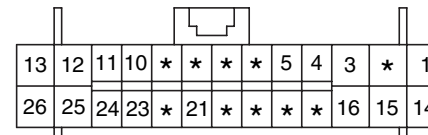

AMP_0407_26F_W_HD

C258(3.3L)

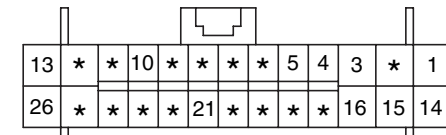

AMP_0407_26F_W_HD

C280(2.7L)

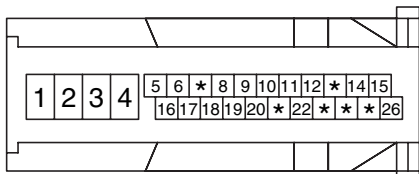

BOS_ABS_26F_B_L

C280(DSL)

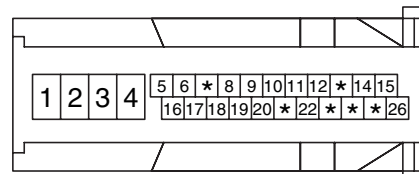

BOS_ABS_26F_B_L

M10

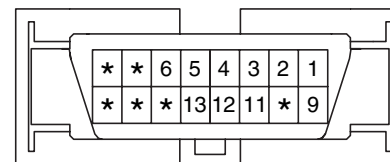

MLX_OBDII_16F_B_SIN

M41-A

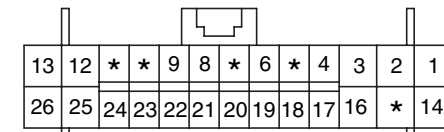

AMP_0407_26F_W_HD

SEMI ACTIVE ENGINE MOUNTING CONTROL SYSTEM

SEMI ACTIVE ENGINE MOUNTING CONTROL SYSTEM (2)

SD218-2

C30-A

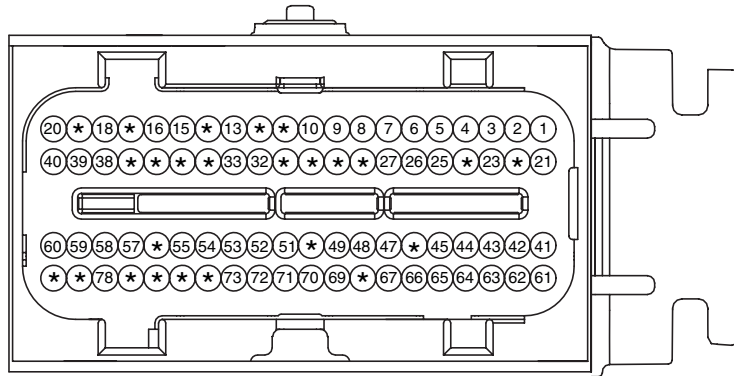

PKD_ECU_80F_Gr_NR

C130-A

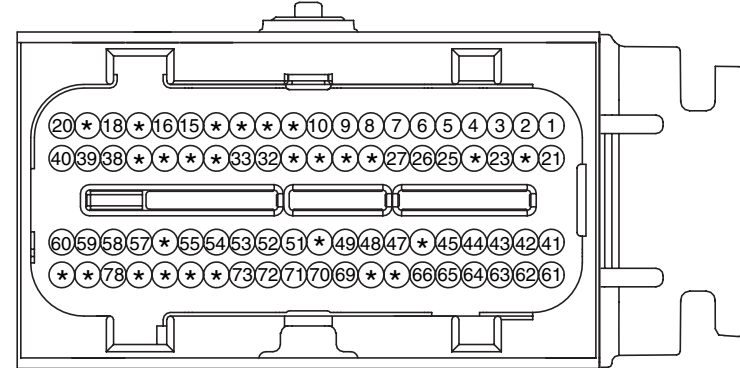

PKD_ECU_80F_Gr_3

C98

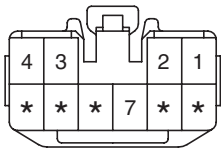

KET_090II_10F_W

E07

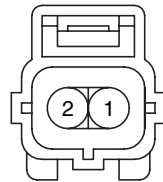

AMP_EJWP_02F_B

E14/E114

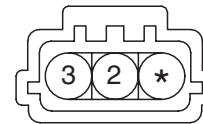

SUM_ALTWP_03F_GR

M15-A

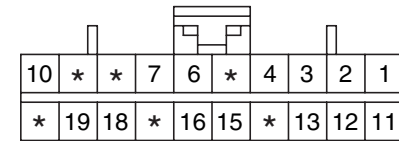

AMP_040M2_20F_B

COOLING SYSTEM (1)

SD253-1

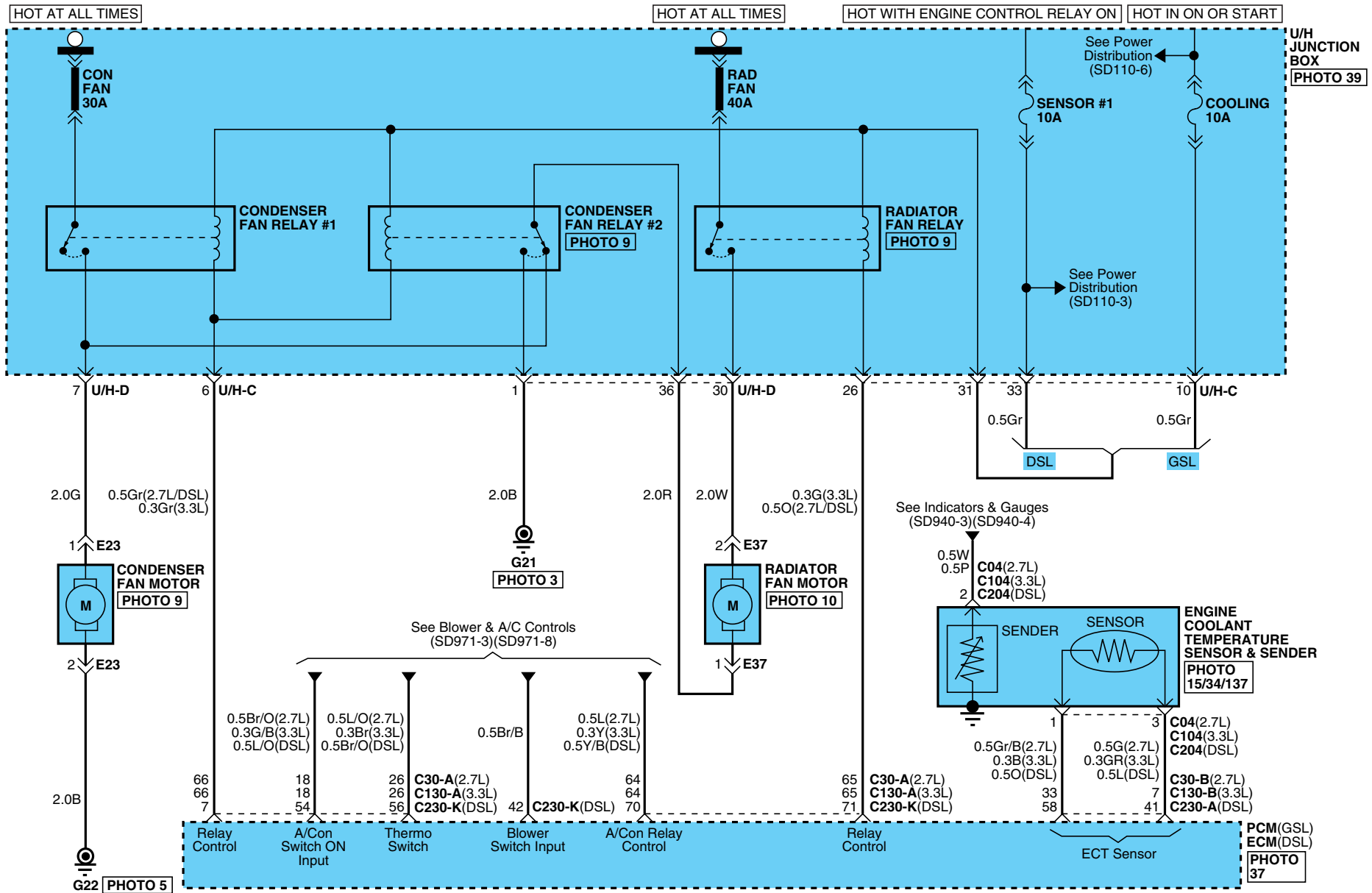

COOLING SYSTEM

COOLING SYSTEM (2)

SD253-2

C04

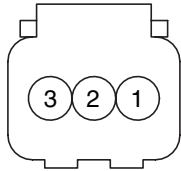

KUM_WTS_03F_B

C104/C204

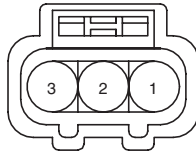

KUM_62Z_03F_B_WTS

C30-A

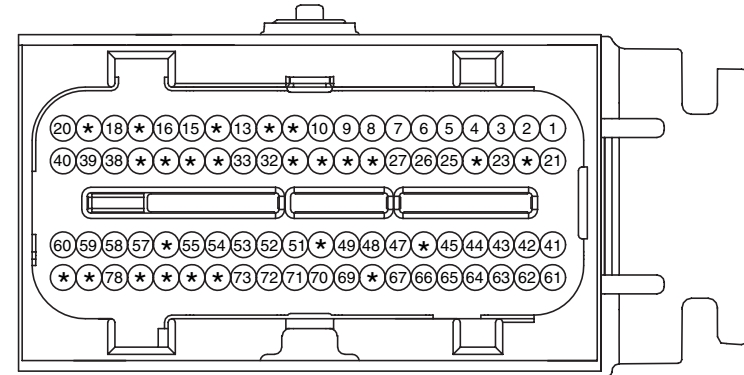

PKD_ECU_80F_Gr_NR

C130-B

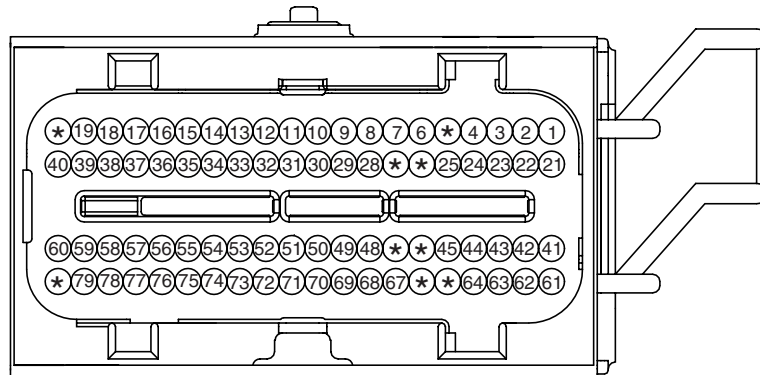

PKD_ECU_80F_B_R

C130-A

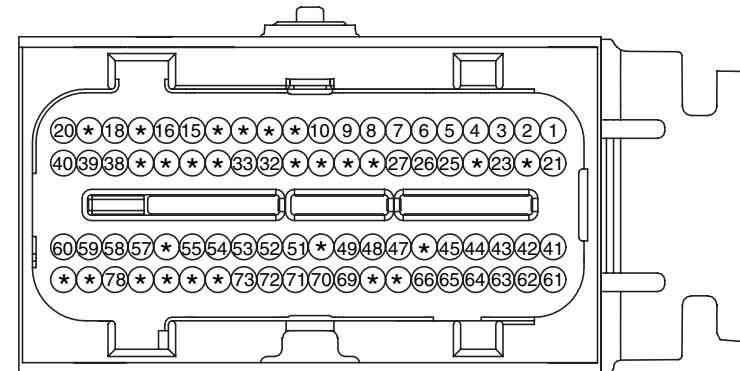

PKD_ECU_80F_Gr_3

C230-A

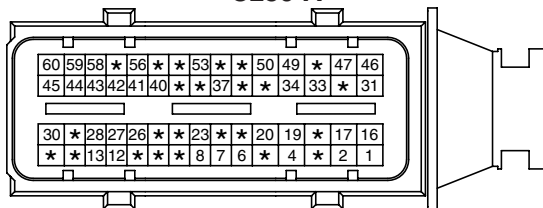

AMP_ECU_60F_B

C230-K

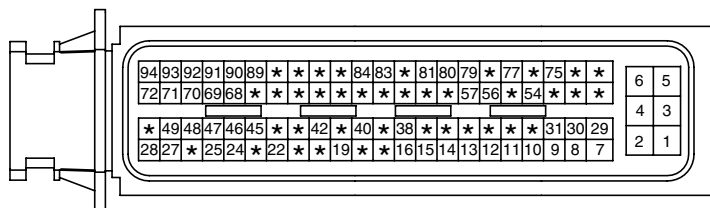

AMP_ECU_94F_B

E23

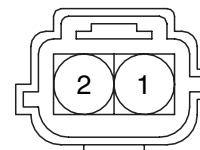

KUM_WWP_02F_B

E37

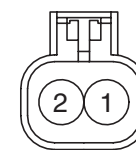

KET_58X_02F_B

MFI CONTROL SYSTEM (DSL 2.2L) (1)

SD313-1

EURO -IV

HOT AT ALL TIMES

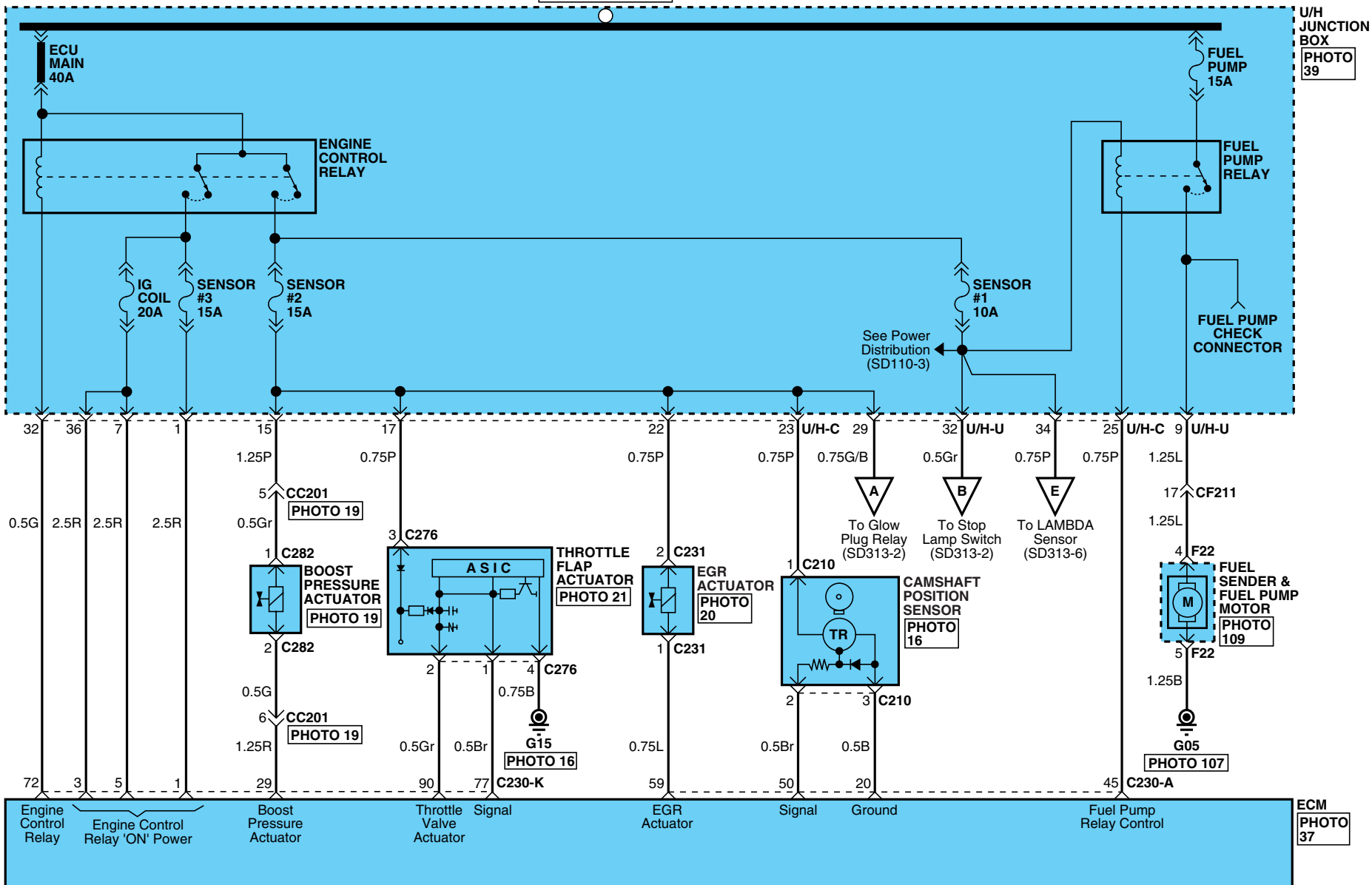

U/H JUNCTION BOX PHOTO 39

ECM PHOTO 37

MFI CONTROL SYSTEM

MFI CONTROL SYSTEM (DSL 2.2L) (3)

SD313-3

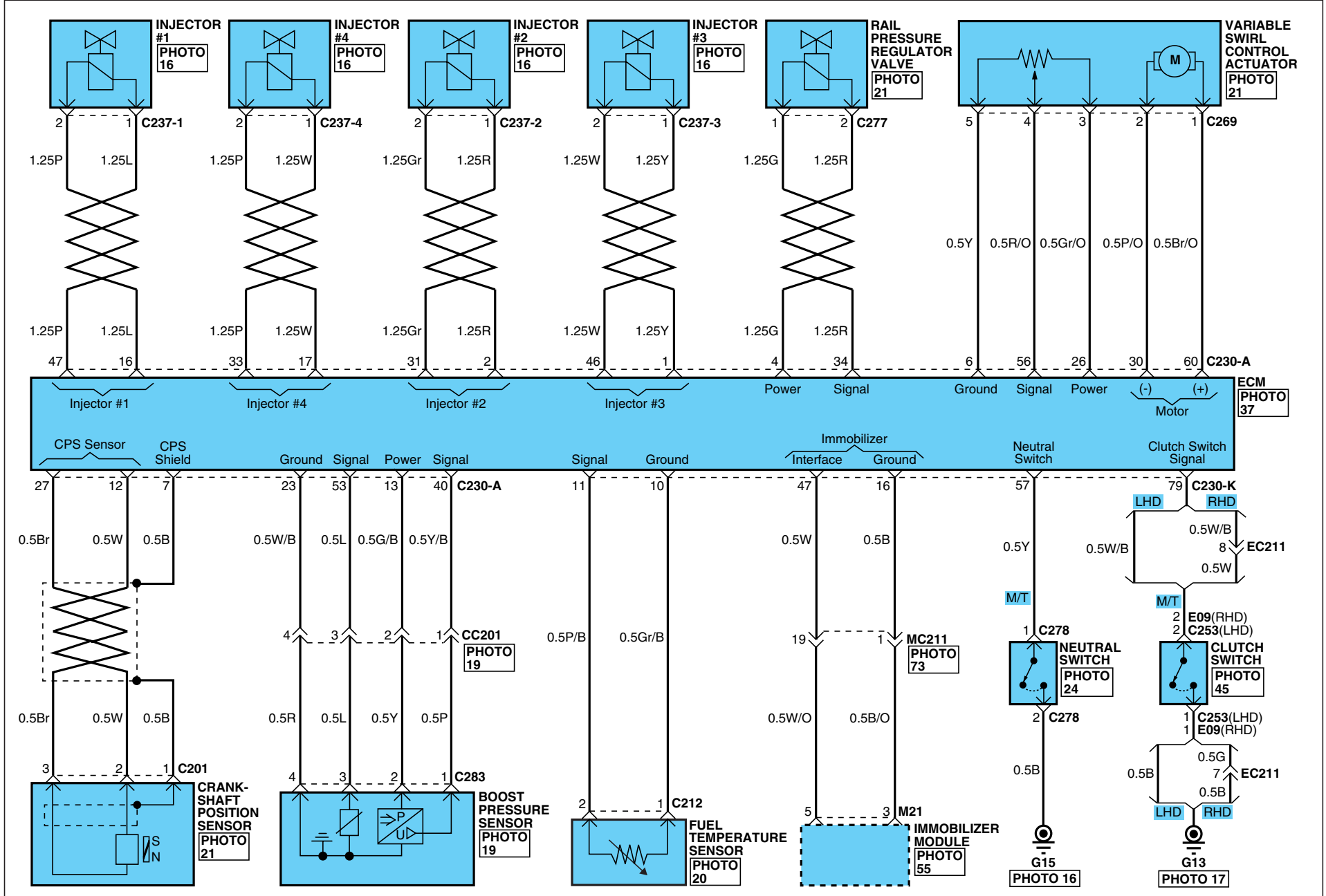

MFI CONTROL SYSTEM

MFI CONTROL SYSTEM (DSL 2.2L) (4)

SD313-4

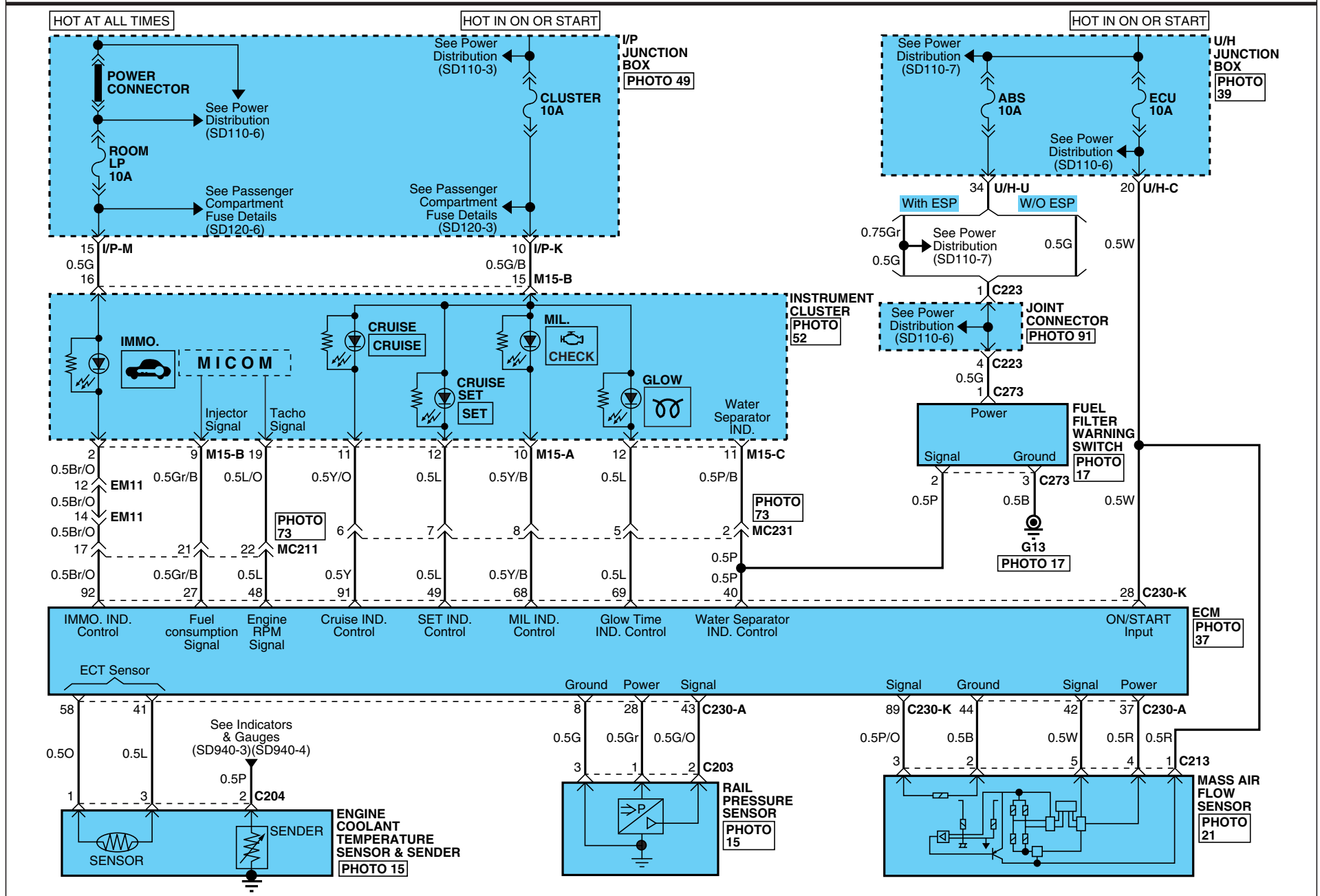

MFI CONTROL SYSTEM

MFI CONTROL SYSTEM (DSL 2.2L) (5)

SD313-5

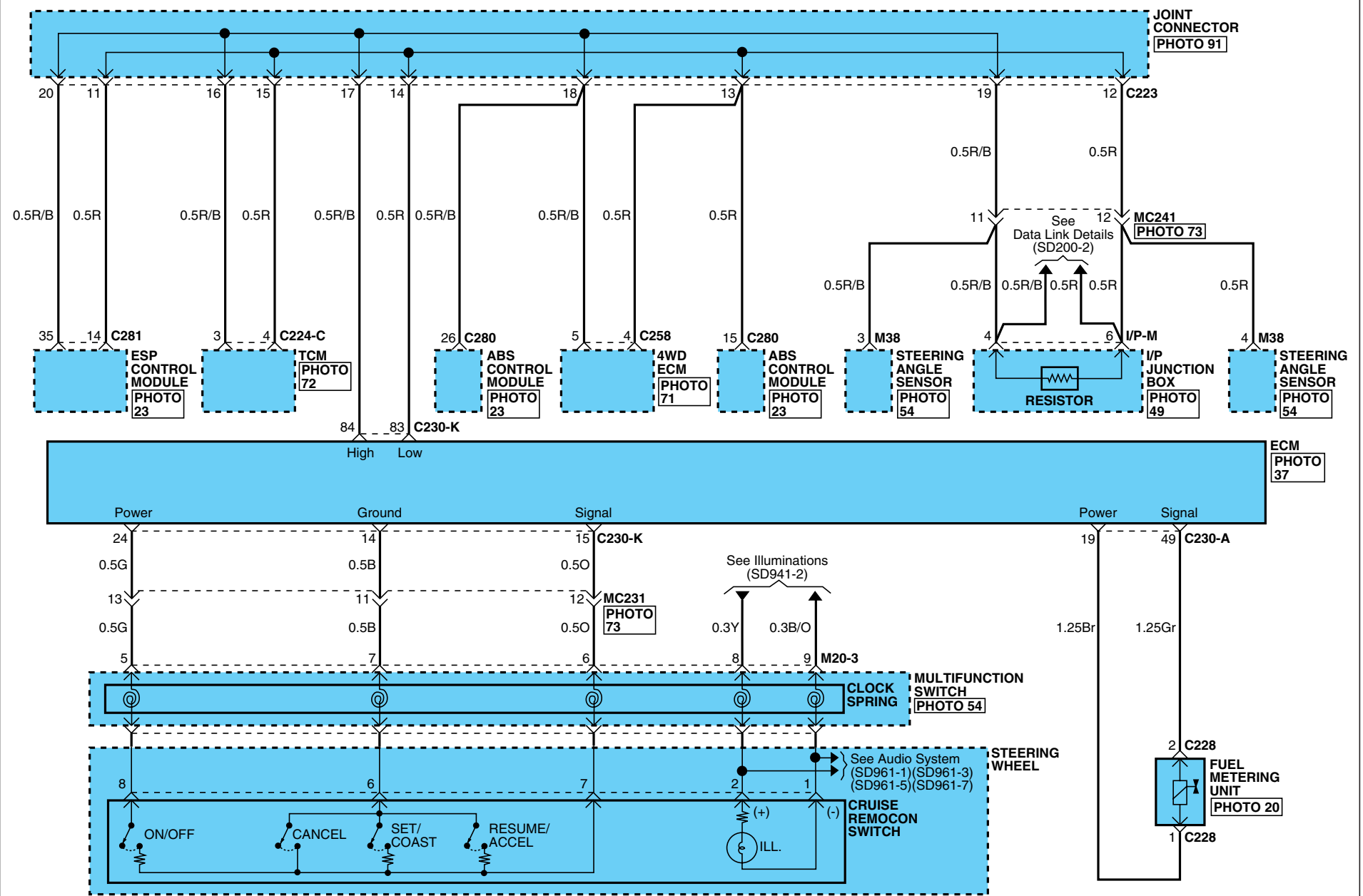

MFI CONTROL SYSTEM

MFI CONTROL SYSTEM (DSL 2.2L) (6)

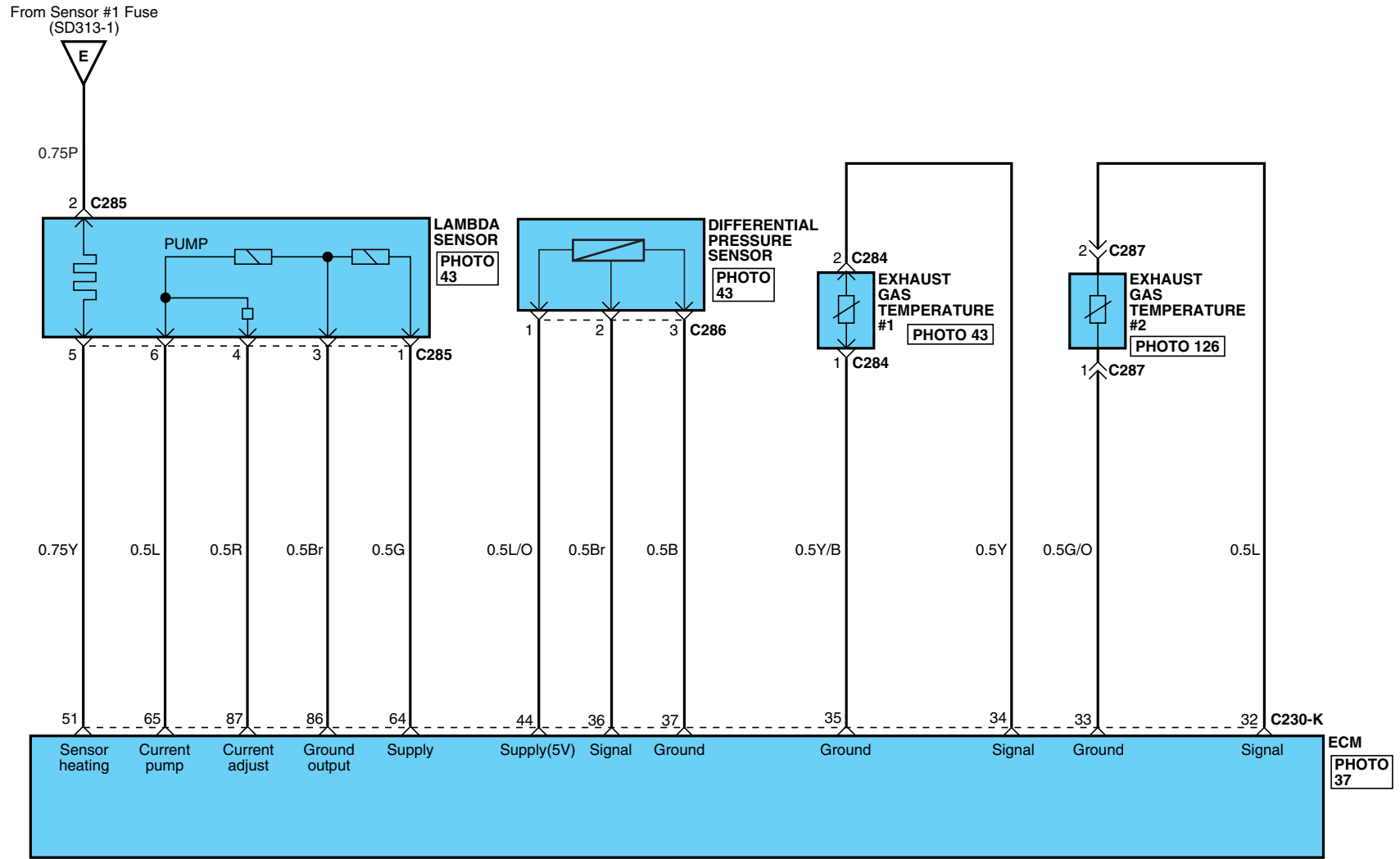

SD313-6



MFI CONTROL SYSTEM

MFI CONTROL SYSTEM (DSL 2.2L) (7)

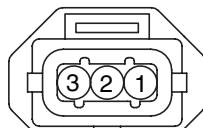
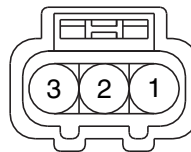
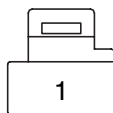

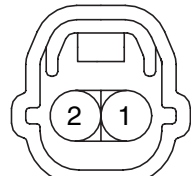
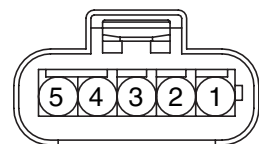
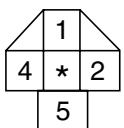
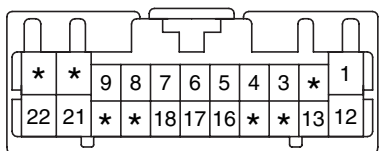
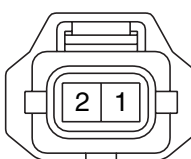
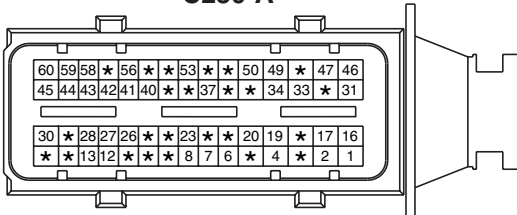
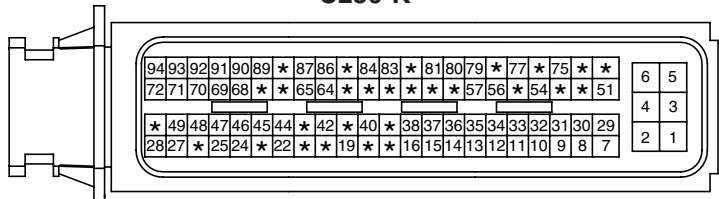
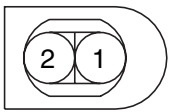
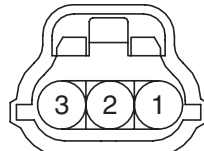
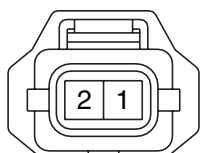
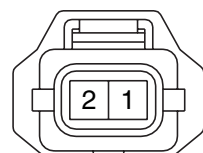
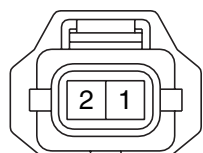
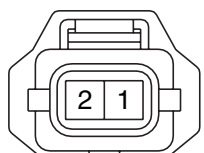



SD313-7

<p>C201</p>  <p>AMP_2.8WP_3F_B_SNSR</p>	<p>C203</p>  <p>AMP_2.8WP_3F_B_R-PRESS</p>	<p>C204</p>  <p>KUM_WTS_62Z_03F_B</p>	<p>C206</p>  <p>KET_58L_01F_B</p>
<p>C210</p>  <p>AMP_2.8WP_3F_B_SNSR</p>	<p>C212</p>  <p>KET_SSD_02F_B</p>	<p>C213</p>  <p>HIRSCHMANN_SNSR_05F</p>	<p>C218</p>  <p>CR05F031</p>
<p>C224-C</p>  <p>KET_0407_22F_W</p>	<p>C228</p>  <p>AMP_2.8WP_2F_B_SNSR</p>	<p>C230-A</p>  <p>AMP_ECU_60F_B</p>	
<p>C230-K</p>  <p>AMP_ECU_94F_B</p>		<p>C231</p>  <p>KET_SENSOR_02F_B_NF</p>	<p>C235</p>  <p>KET_040WP_03F_B</p>
<p>C237-1</p>  <p>AMP_2.8WP_2F_B_SNSR</p>	<p>C237-2</p>  <p>AMP_2.8WP_2F_B_SNSR</p>	<p>C237-3</p>  <p>AMP_2.8WP_2F_B_SNSR</p>	<p>C237-4</p>  <p>AMP_2.8WP_2F_B_SNSR</p>

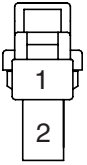
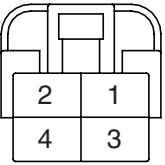
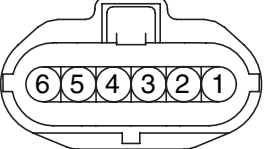
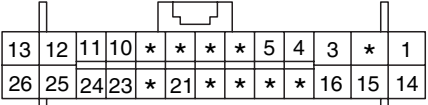
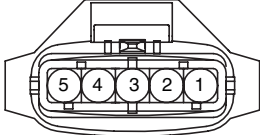
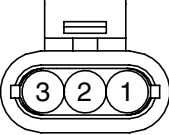
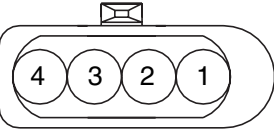
MFI CONTROL SYSTEM

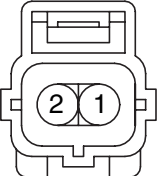
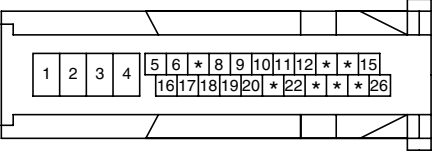
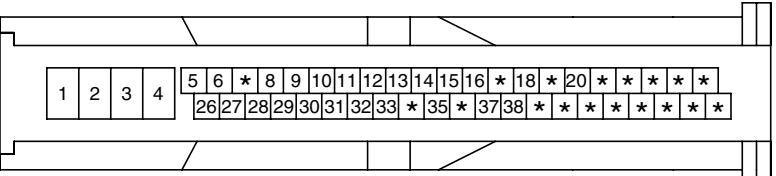
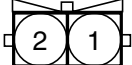
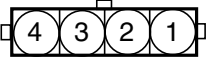
MFI CONTROL SYSTEM (DSL 2.2L) (8)

SD313-8

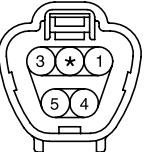
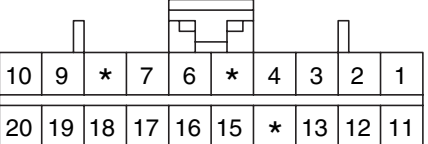
<p>C253/E09</p>  <p>KET_250DL_02F_W</p>	<p>C254</p>  <p>KET_250DL_04F_W</p>	<p>C256/E08</p>  <p>AMP_070WP_06F_B</p>	<p>C258</p>  <p>AMP_0407_26F_W_HD</p>
<p>C269</p>  <p>AMP_JPT_05F_B_SFT</p>	<p>C273</p>  <p>AMP_1.5WP_03F_B</p>	<p>C276</p>  <p>FBP_NFDSL_04F_N</p>	<p>C277</p>  <p>AMP_2.8WP_2F_B_SNSR</p>
<p>C278</p>  <p>AMP_EJWP_02F_B</p>	<p>C280</p>  <p>BOS_ABS_26F_B_L</p>	<p>C281</p>  <p>BOS_ESP_46F_B_L</p>	
<p>C282</p>  <p>CR02F041</p>	<p>C283</p>  <p>CR04F005</p>	<p>C284</p>  <p>AMP_2.8WP_02F_B_SNSR</p>	<p>C285</p>  <p>BSH_SENSOR_06F_B_NF</p>
<p>C286</p>  <p>SUM_090IWP_03F_B</p>	<p>C287</p>  <p>AMP_2.8WP_02F_B_SNSR</p>	<p>F22</p>  <p>KET_090IWP_05F_Gr_2</p>	<p>M15-A</p>  <p>AMP_040M2_20F_B</p>

MFI CONTROL SYSTEM

MFI CONTROL SYSTEM (DSL 2.2L) (9)

SD313-9

M15-B

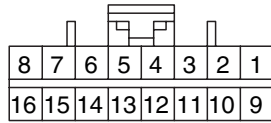

AMP_040M2_16F_B

M15-C

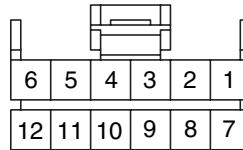

AMP_040M1_12F_B

M20-3

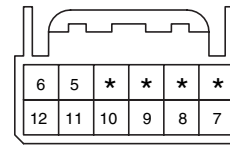

AMP_025_12F_W

M21

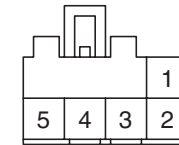

KUM_CDR_05F_W

M38

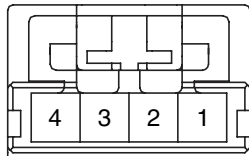

AMP_MQS_04F_B_040

BLANK

BLANK

BLANK

MFI CONTROL SYSTEM

MFI CONTROL SYSTEM (DSL 2.2L) (10)

SD313-10

MEMO

MFI CONTROL SYSTEM (GSL 2.7L) (1)

SD313-11

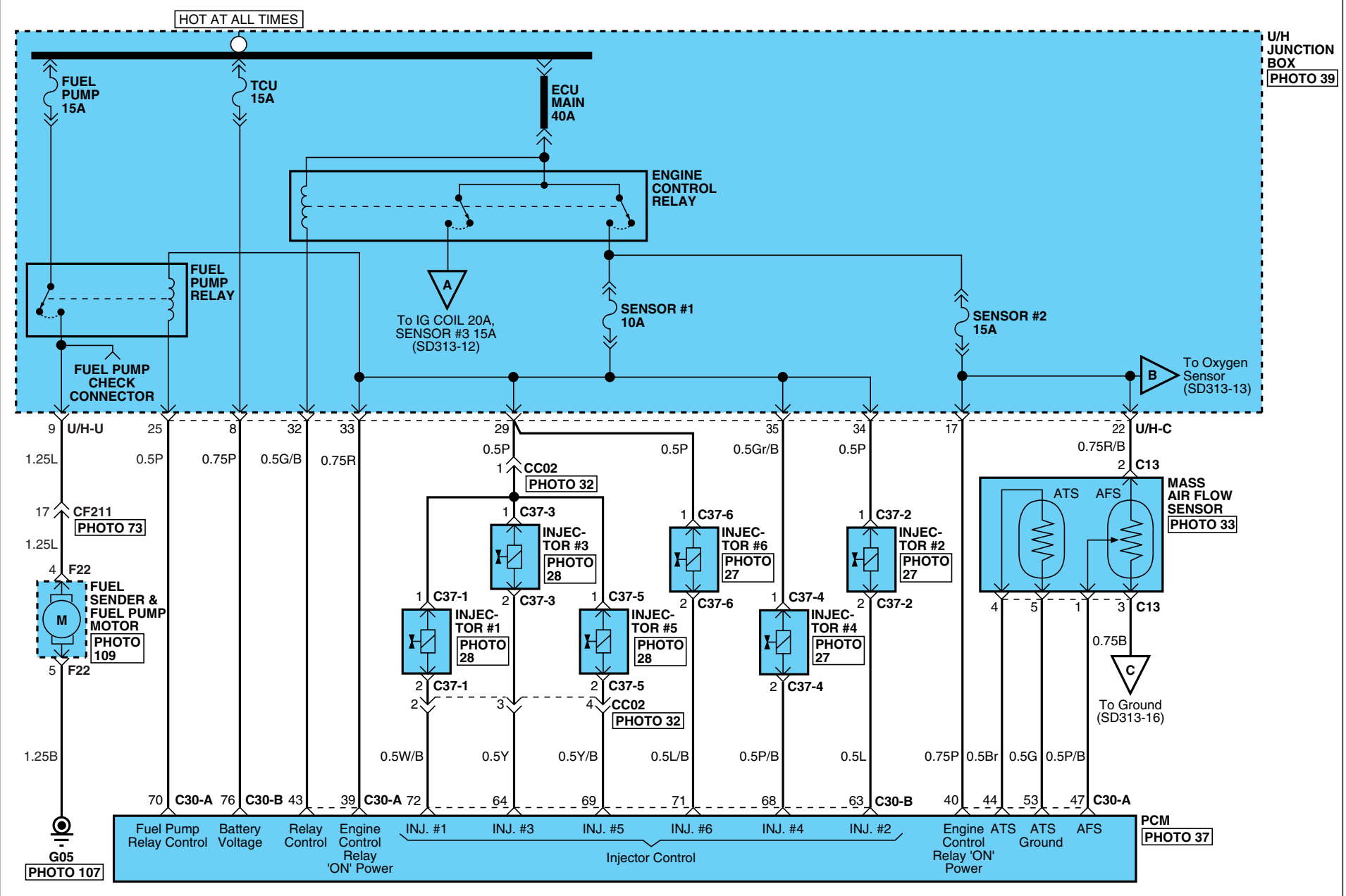

MFI CONTROL SYSTEM

MFI CONTROL SYSTEM (GSL 2.7L) (2)

SD313-12

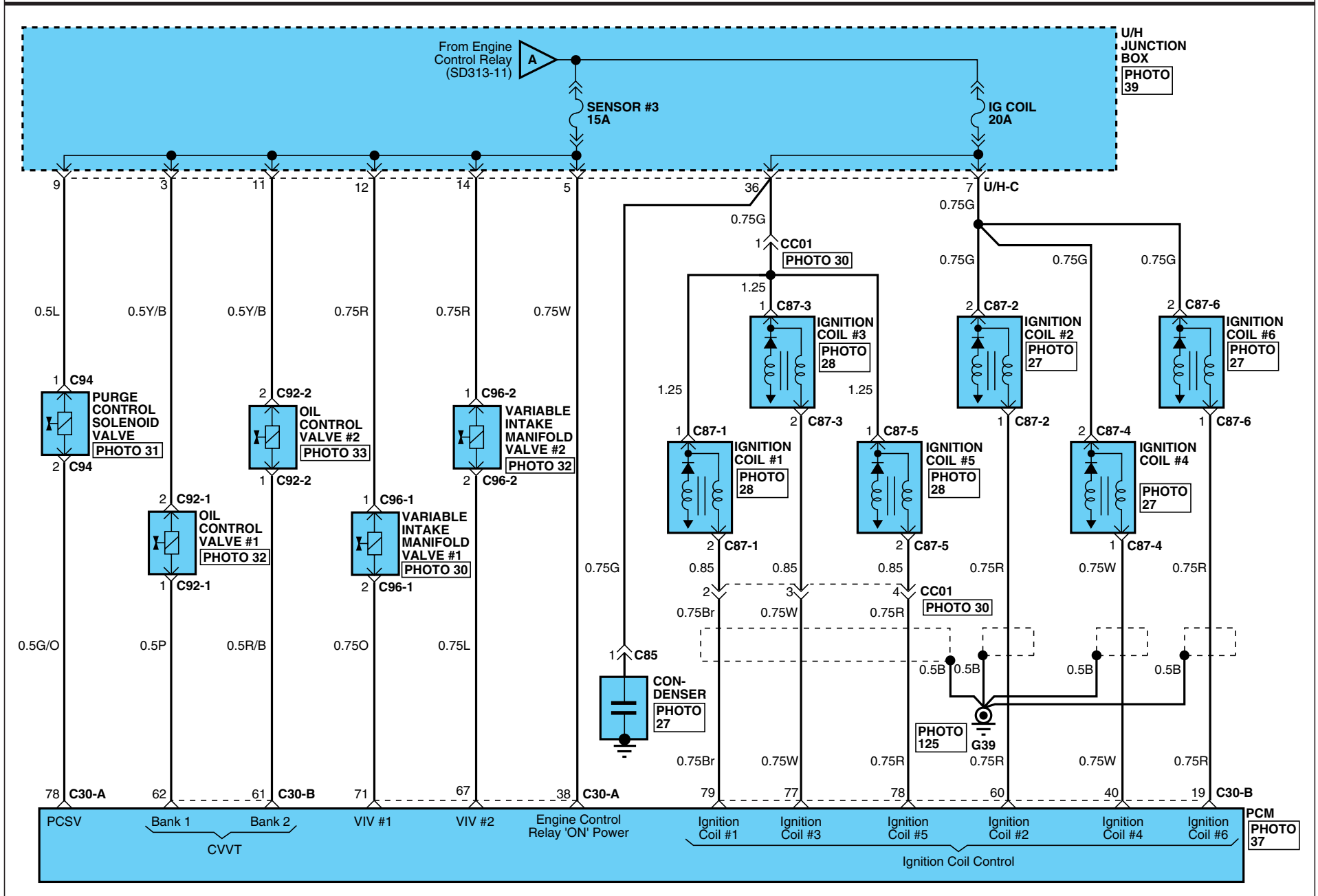

MFI CONTROL SYSTEM

MFI CONTROL SYSTEM (GSL 2.7L) (4)

SD313-14

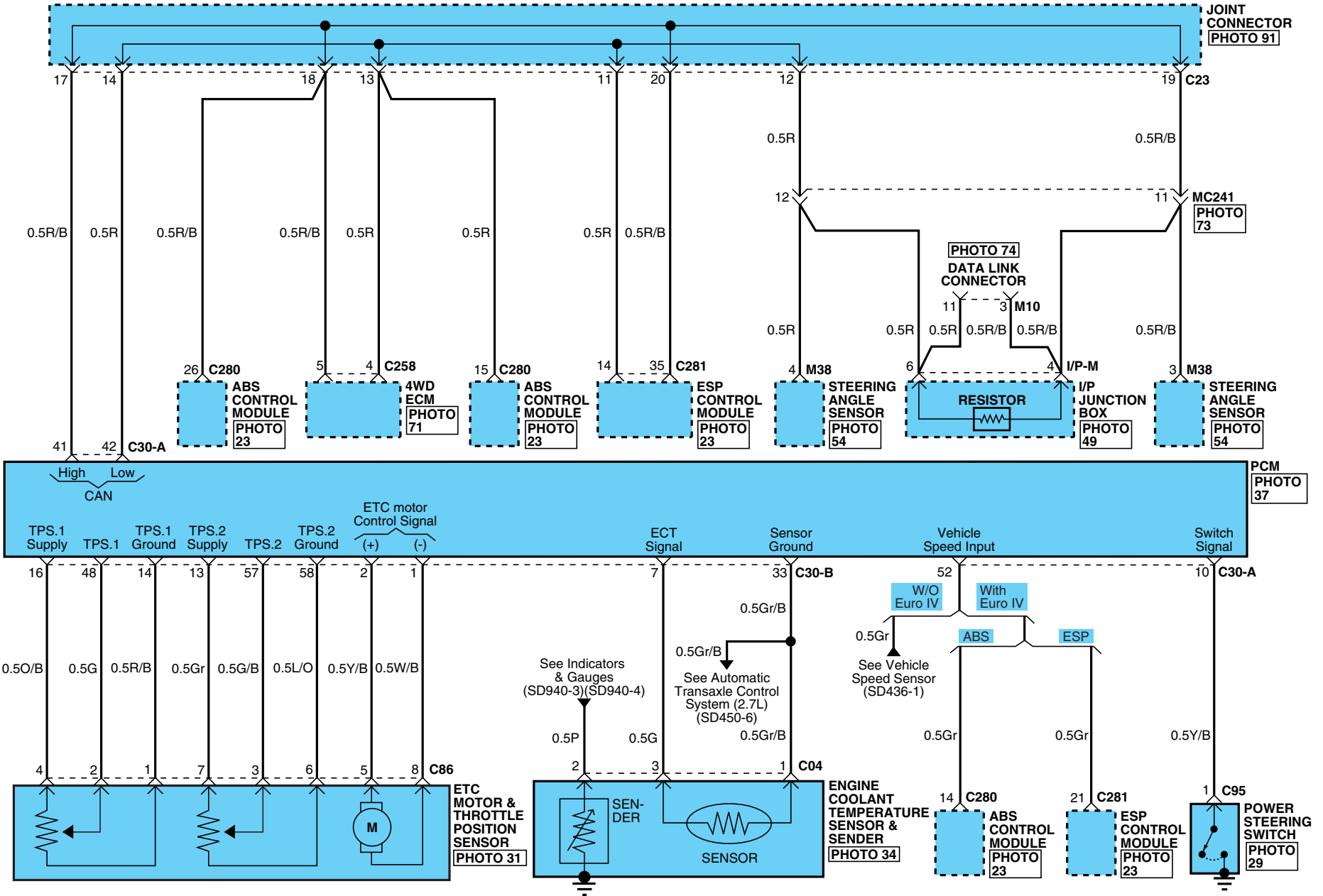

MFI CONTROL SYSTEM

MFI CONTROL SYSTEM (GSL 2.7L) (5)

SD313-15

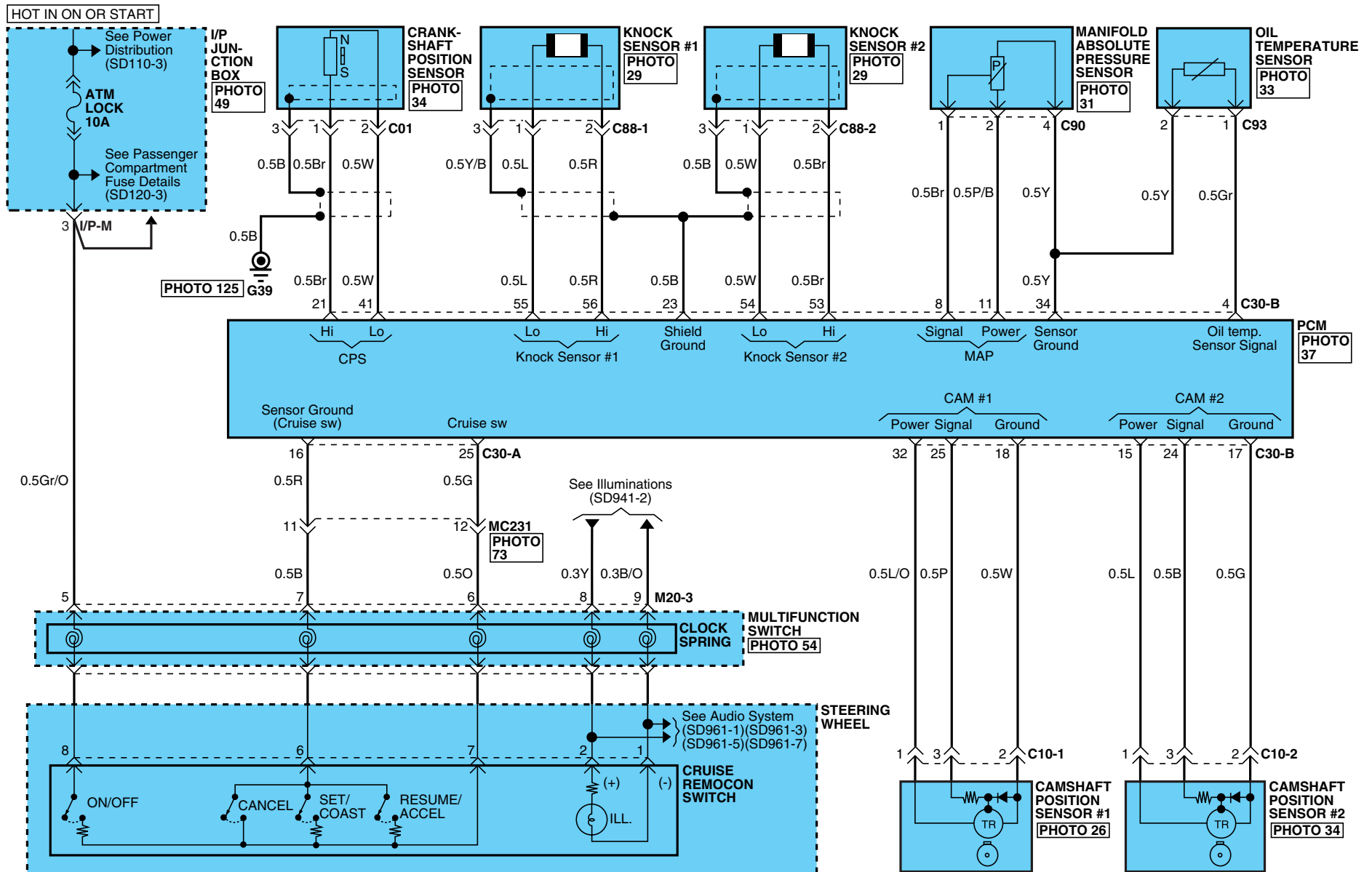

MFI CONTROL SYSTEM

MFI CONTROL SYSTEM (GSL 2.7L) (6)

SD313-16

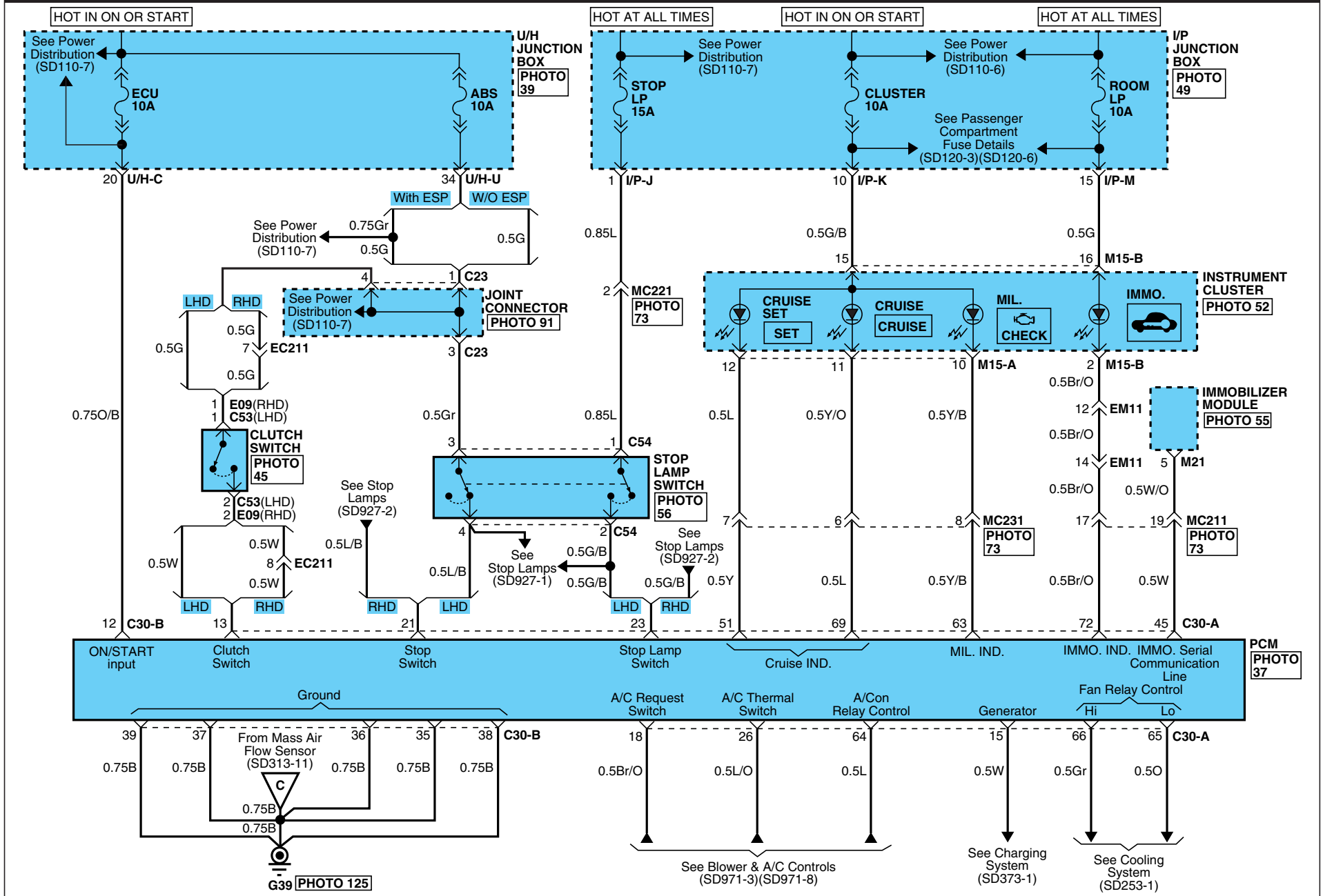

MFI CONTROL SYSTEM

MFI CONTROL SYSTEM (GSL 2.7L) (7)

SD313-17

C01

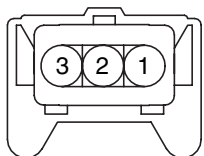

AMP_JPT_03F_B_S1

C04

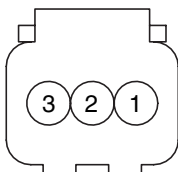

KUM_62ZWP_03F_B_060

C10-1

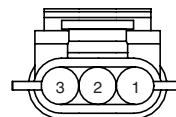

PKD_150WP_03F_B_L

C10-2

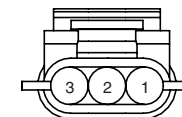

PKD_150WP_03F_B_L

C30-A

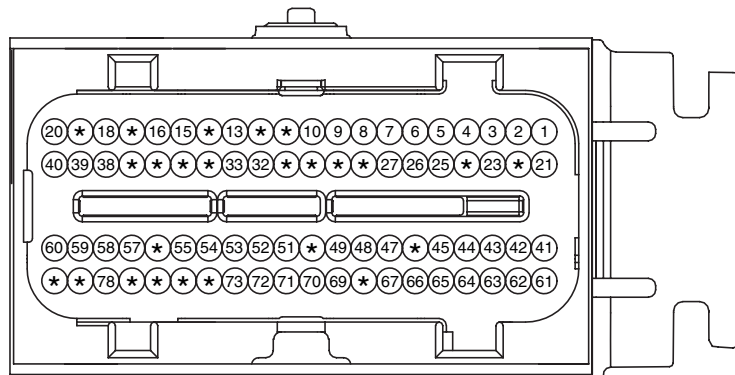

PKD_ECU_80F_Gr_NR

C30-B

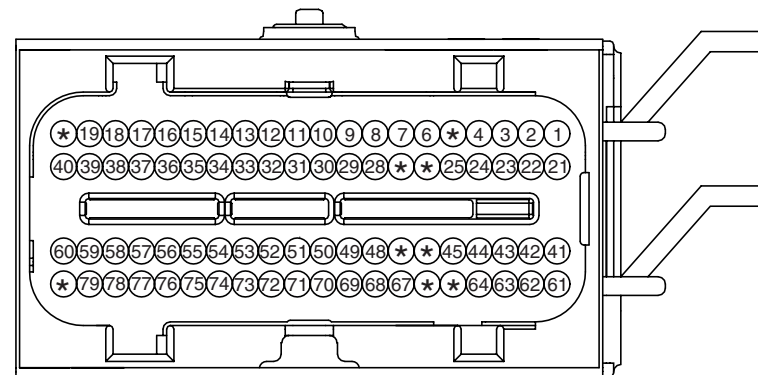

PKD_ECU_80F_B_R

C13

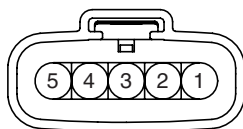

PKD_GT150_05F_B

C35

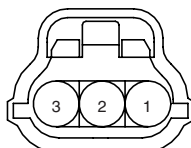

KET_040WP_03F_B

C37-1

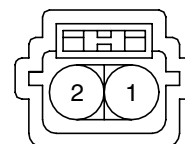

KUM_NDWP_02F_B

C37-2

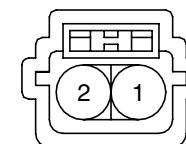

KUM_NDWP_02F_B

C37-3

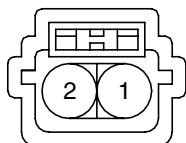

KUM_NDWP_02F_B

C37-4

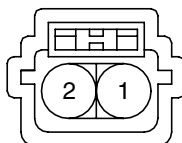

KUM_NDWP_02F_B

C37-5

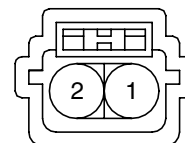

KUM_NDWP_02F_B

C37-6

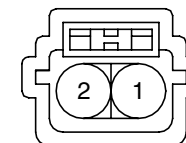







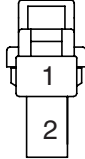
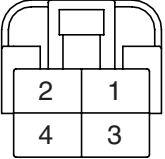
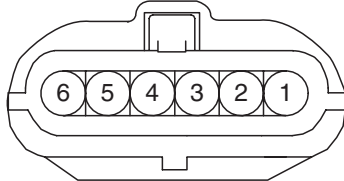
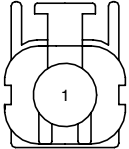

KUM_NDWP_02F_B

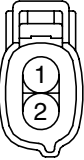
MFI CONTROL SYSTEM

MFI CONTROL SYSTEM (GSL 2.7L) (8)

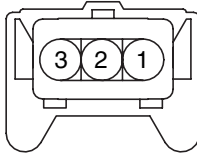
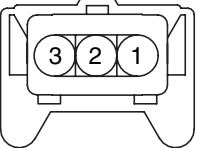
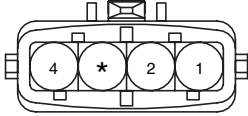
SD313-18

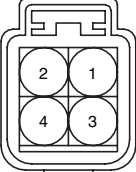
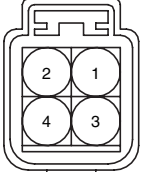
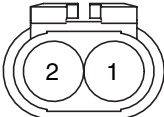
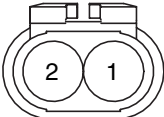
<p>C53/E09</p>  <p>KET_250DL_02F_W</p>	<p>C54</p>  <p>KET_250DL_04F_W</p>	<p>C56/E08</p>  <p>AMP_070WP_06F_B</p>	<p>C85</p>  <p>KET_58X_01F_B</p>
<p>C86</p>  <p>PKD_GT150_08F_B</p>	<p>C87-1</p>  <p>MLX_090WP_02F_B</p>	<p>C87-2</p>  <p>MLX_090WP_02F_B</p>	<p>C87-3</p>  <p>MLX_090WP_02F_B</p>
<p>C87-4</p>  <p>MLX_090WP_02F_B</p>	<p>C87-5</p>  <p>MLX_090WP_02F_B</p>	<p>C87-6</p>  <p>MLX_090WP_02F_B</p>	<p>C88-1</p>  <p>AMP_JPT_03F_Gr_R2</p>
<p>C88-2</p>  <p>AMP_JPT_03F_B_S2</p>	<p>C90</p>  <p>AMP_JPT_04F_B_BOSCH</p>	<p>C91-1</p>  <p>KUM_KNMWP_04F_B</p>	<p>C91-2</p>  <p>KUM_KNMWP_04F_B</p>
<p>C91-3</p>  <p>KUM_NMWP_04F_Gr</p>	<p>C91-4</p>  <p>KUM_NMWP_04F_Gr</p>	<p>C92-1</p>  <p>PKD_GT150_02F_GR_1</p>	<p>C92-2</p>  <p>PKD_GT150_02F_B_1</p>

MFI CONTROL SYSTEM

MFI CONTROL SYSTEM (GSL 2.7L) (9)

SD313-19

C93

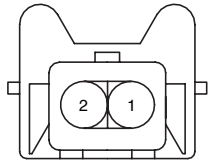

AMP_JPT_02F_B_CLIP

C94

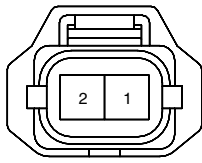

AMP_2.8WP_02F_B

C95



AMP_EJWP_01F_B

C96-1

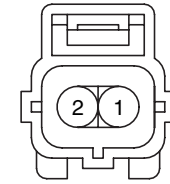

AMP_EJWP_02F_B

C96-2

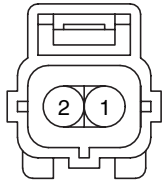

AMP_EJWP_02F_B

C98

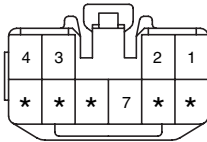

KET_090II_10F_W

C245 (GSL)

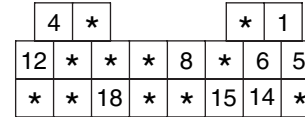

KET_DIAGNOSIS_20F_B_A

BLANK

C258

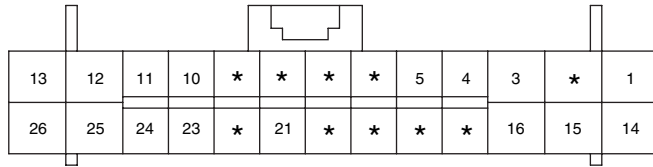

AMP_0407_26F_W_HD

C280

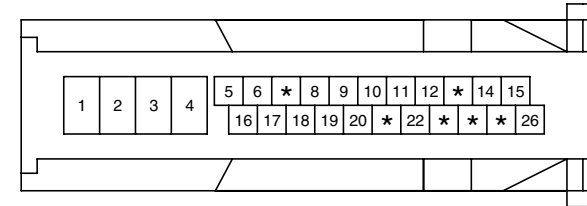

BOS_ABS_26F_B_L

C281

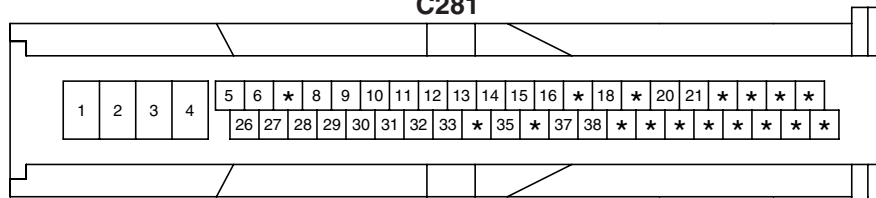

BOS_ESP_46F_B_L

F22

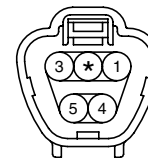

KET_090IWP_05F_Gr_2

M10

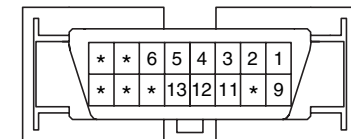

MLX_OBDII_16F_B_SIN

M15-A

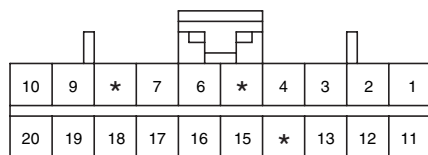

AMP_040M2_20F_B

M15-B

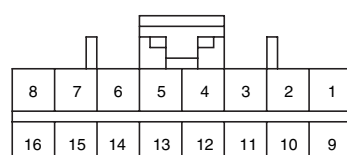

AMP_040M2_16F_B

M20-3

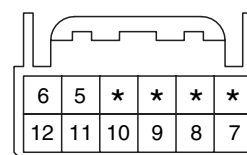

AMP_025_12F_W

M21

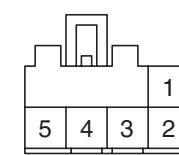

KUM_CDR_05F_W

MFI CONTROL SYSTEM

MFI CONTROL SYSTEM (GSL 2.7L) (10)

SD313-20

M38

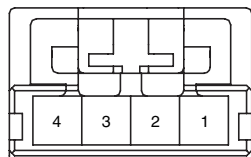

AMP_MQS_04F_B_040

BLANK

BLANK

BLANK

MFI CONTROL SYSTEM (GSL 3.3L) (1)

SD313-21

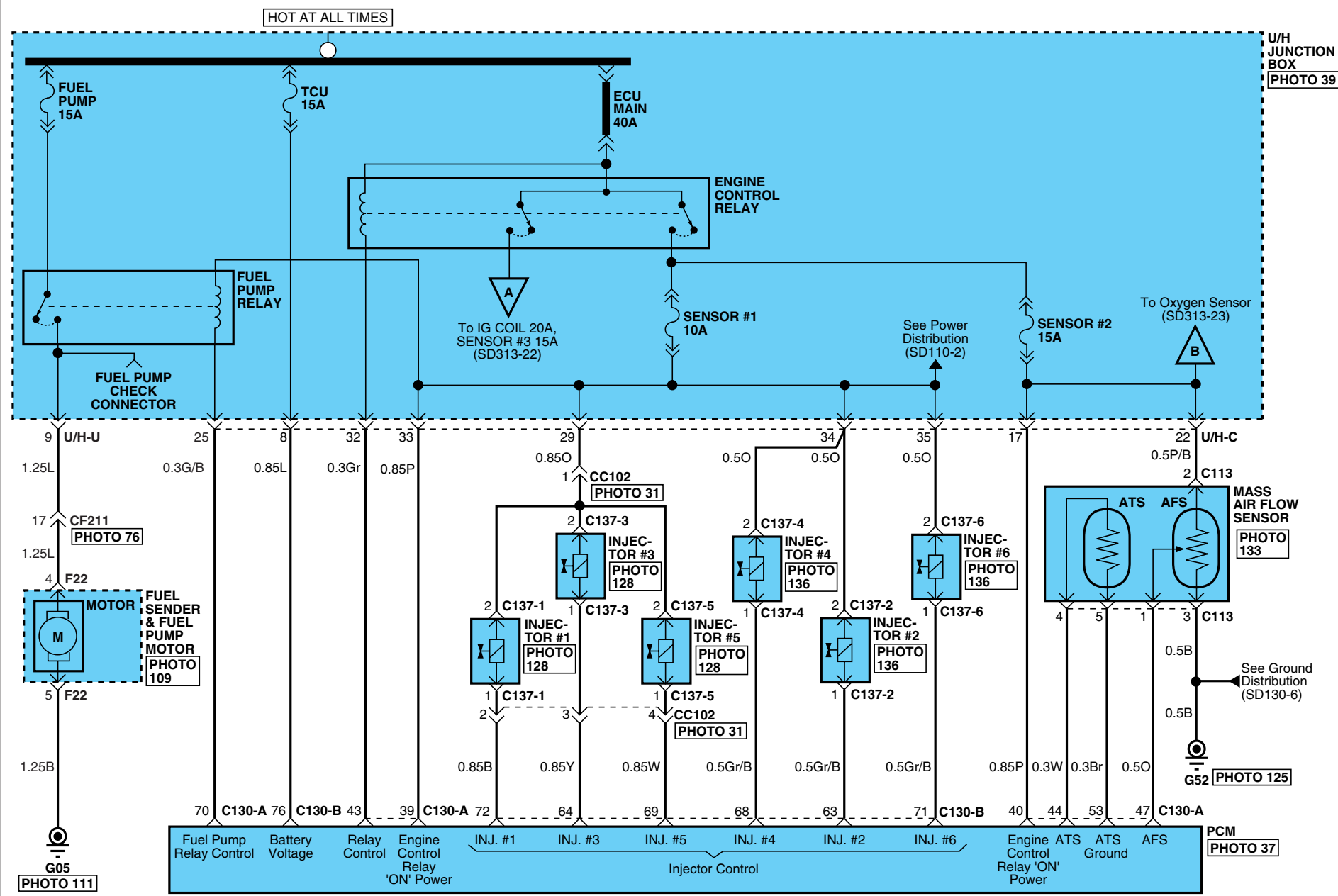

U/H JUNCTION BOX PHOTO 39

9 U/H-U
1.25L
17 CF211 PHOTO 76
1.25L
4 F22
5 F22
1.25B
G05 PHOTO 111

25 0.3G/B
8 0.85L
32 0.3Gr
33 0.85P
70 C130-A
76 C130-B
43

29 0.85O
1 CC102 PHOTO 31
2 C137-3
INJEC-TOR #3 PHOTO 128
2 C137-1
INJEC-TOR #1 PHOTO 128
1 C137-1
2 C137-5
INJEC-TOR #5 PHOTO 128
1 C137-5
4 CC102 PHOTO 31
0.85B
0.85Y
0.85W
64
69
68
63
71 C130-B

0.50
34 0.50
35 0.50
17
2 C137-4
INJEC-TOR #4 PHOTO 136
2 C137-2
INJEC-TOR #2 PHOTO 136
1 C137-2
0.5Gr/B
0.5Gr/B
0.5Gr/B
40
44
53
47 C130-A

22 U/H-C
0.5P/B
2 C113
MASS AIR FLOW SENSOR PHOTO 133
4 5 1 3 C113
0.5B
0.5B
G52 PHOTO 125

PCM PHOTO 37

MFI CONTROL SYSTEM

MFI CONTROL SYSTEM (GSL 3.3L) (4)

SD313-24

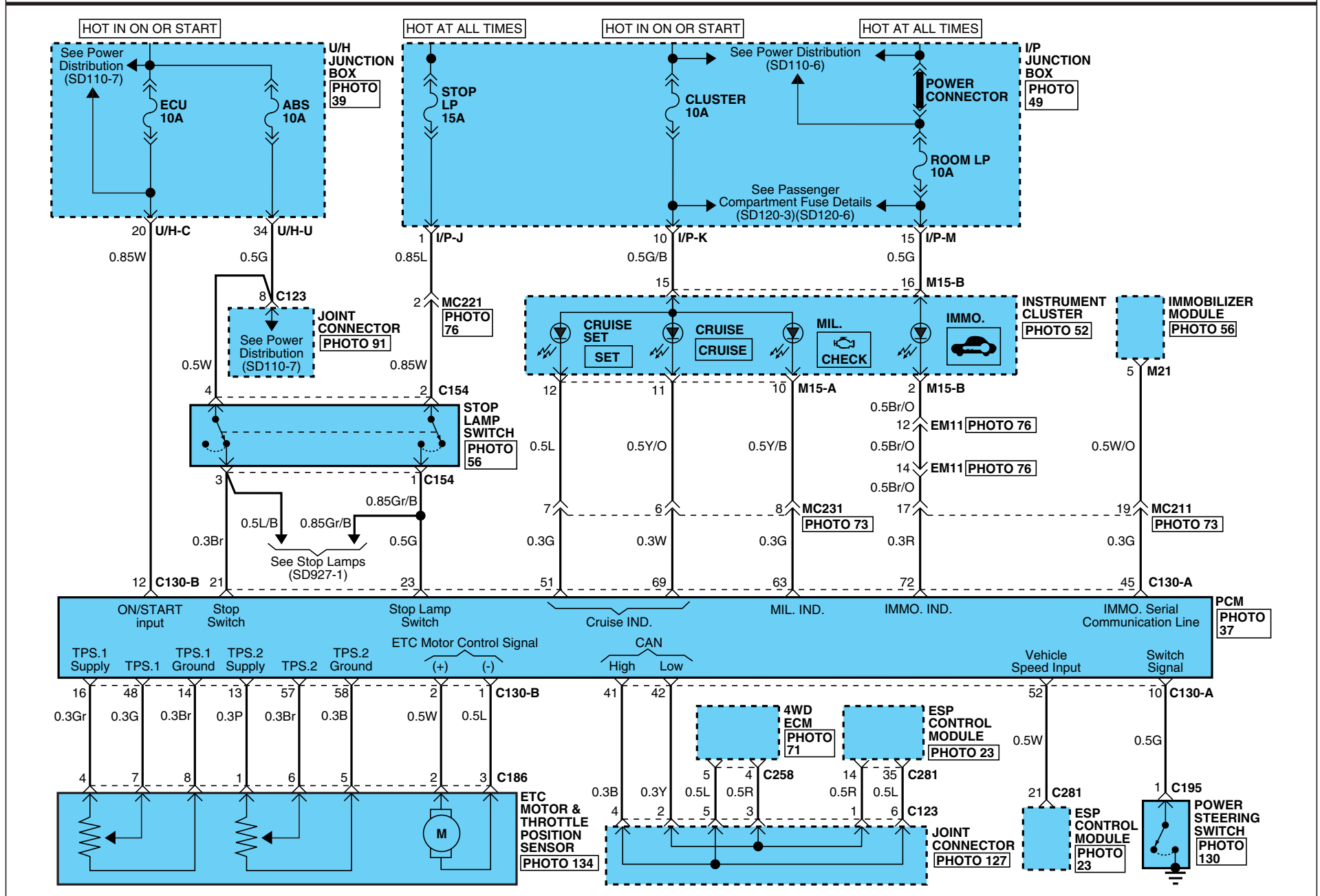

MFI CONTROL SYSTEM

MFI CONTROL SYSTEM (GSL 3.3L) (5)

SD313-25

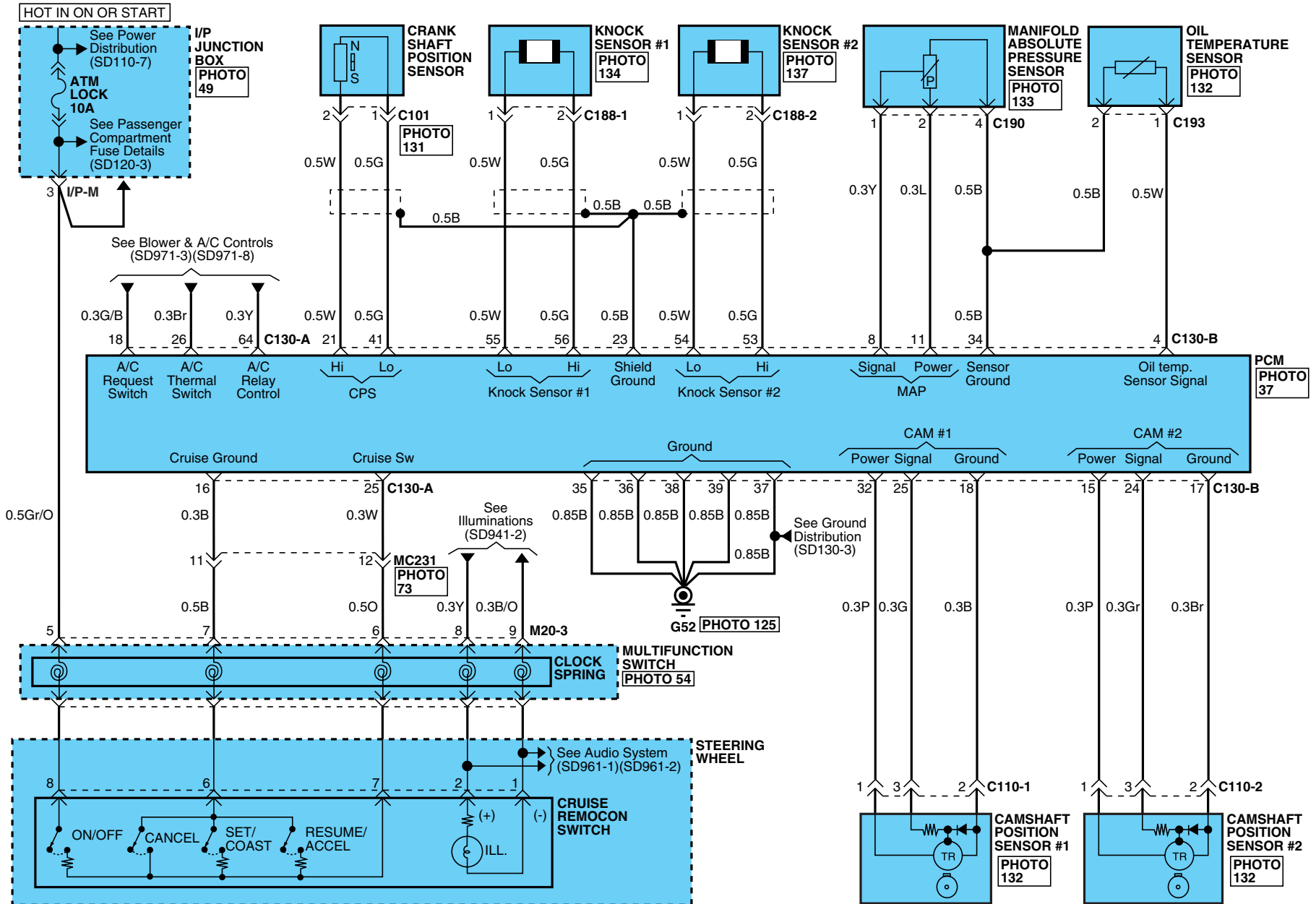

MFI CONTROL SYSTEM

MFI CONTROL SYSTEM (GSL 3.3L) (6)

SD313-26

C98

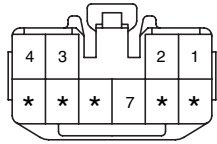

KET_090II_10F_W

C101

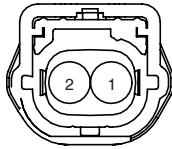

BSH_SENSOR_02F_B

C104

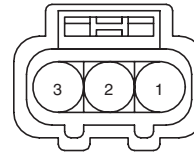

KUM_62Z_03F_B_WTS

C110-1

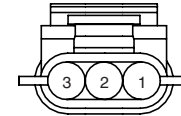

PKD_150WP_03F_B_L

C110-2

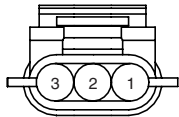

PKD_150WP_03F_B_L

C113

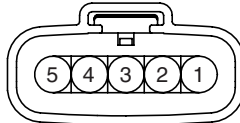

PKD_GT150_05F_B

C130-A

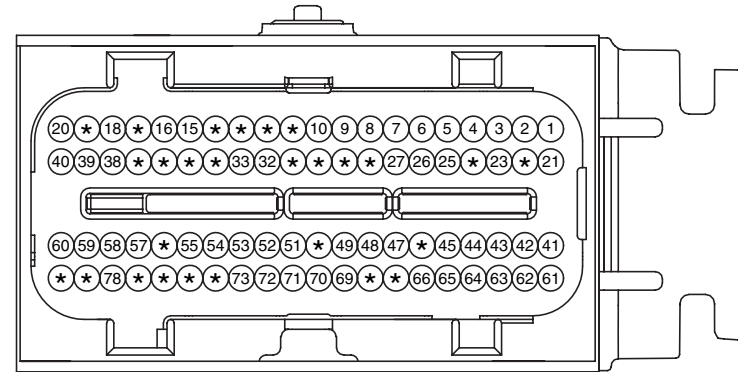

PKD_ECU_80F_Gr_3

C130-B

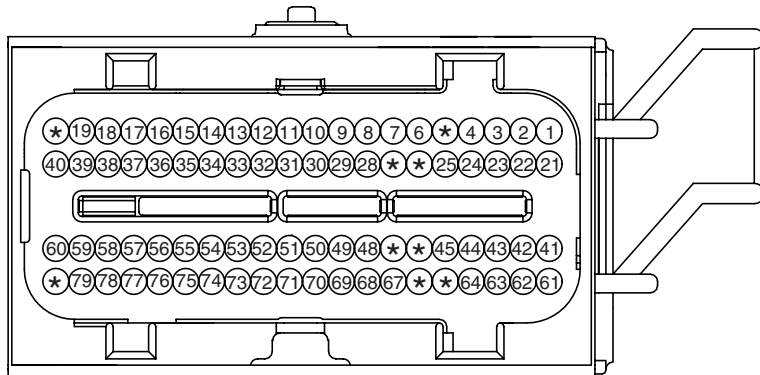

PKD_ECU_80F_B_4

C135

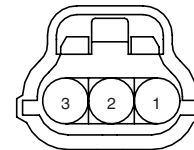

YAZ_040WP_03F_B

C137-1

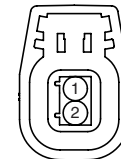

PKD_GT150_02F_B

C137-2

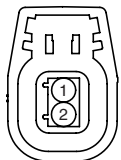

PKD_GT150_02F_B

C137-3

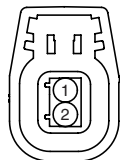

PKD_GT150_02F_B

C137-4

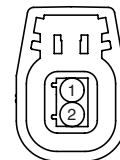

PKD_GT150_02F_B

C137-5

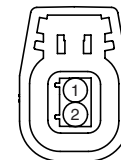







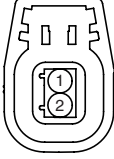
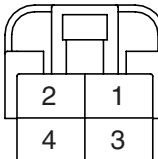
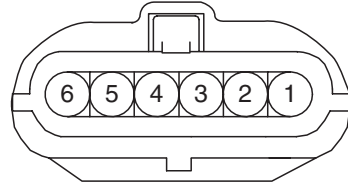
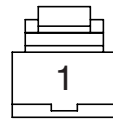

PKD_GT150_02F_B

MFI CONTROL SYSTEM

MFI CONTROL SYSTEM (GSL 3.3L) (7)

SD313-27

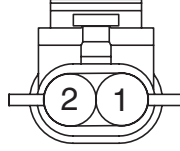
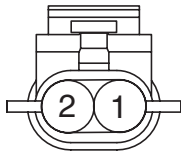
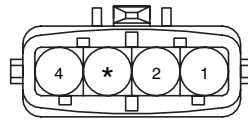
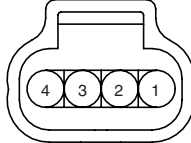
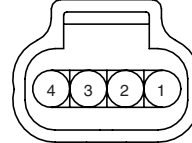
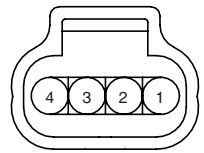
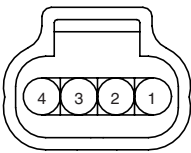
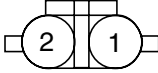
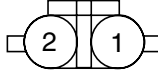
<p>C137-6</p>  <p>PKD_GT150_02F_B</p>	<p>C154</p>  <p>KET_250DL_04F_W</p>	<p>C156</p>  <p>AMP_070WP_06F_B</p>	<p>C185-1,2</p>  <p>KET_250_01F_B_1</p>
<p>C186</p>  <p>PKD_GT150_08F_B</p>	<p>C187-1</p>  <p>KET_090IWP_02F_Gr_VER</p>	<p>C187-2</p>  <p>KET_090IWP_02F_Gr_VER</p>	<p>C187-3</p>  <p>KET_090IWP_02F_Gr_VER</p>
<p>C187-4</p>  <p>KET_090IWP_02F_Gr_VER</p>	<p>C187-5</p>  <p>KET_090IWP_02F_Gr_VER</p>	<p>C187-6</p>  <p>KET_090IWP_02F_Gr_VER</p>	<p>C188-1</p>  <p>PKD_MP150_02F_Gr</p>
<p>C188-2</p>  <p>PKD_MP150_02F_Gr</p>	<p>C190</p>  <p>AMP_JPT_04F_B_BOSCH</p>	<p>C191-1</p>  <p>PKD_GT150_04F_Gr</p>	<p>C191-2</p>  <p>PKD_GT150_04F_B</p>
<p>C191-3</p>  <p>PKD_GT150_04F_B</p>	<p>C191-4</p>  <p>PKD_GT150_04F_Gr</p>	<p>C192-1</p>  <p>CR02F134</p>	<p>C192-2</p>  <p>CR02F134</p>

MFI CONTROL SYSTEM

MFI CONTROL SYSTEM (GSL 3.3L) (8)

SD313-28

C193

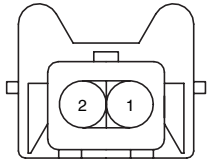

AMP_JPT_02F_B_CLIP

C194

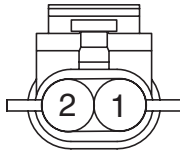

PKD_MP150_02F_B

C195



KUM_NMWP_01F_B

C196

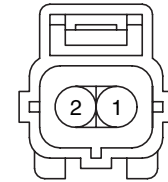

AMP_EJWP_02F_B

C245 (GSL)

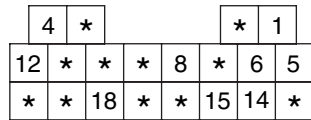

KET_DIAGNOSIS_20F_B_A

C258

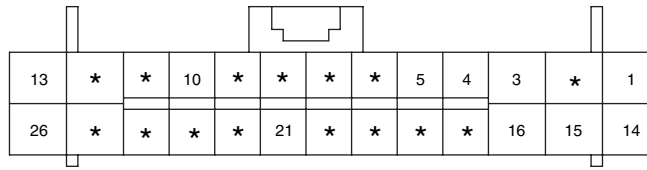

AMP_0407_26F_W_HD

BLANK

C281

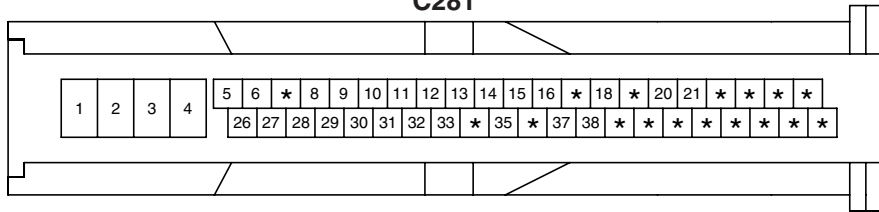

BOS_ESP_46F_B_L

F22

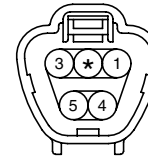

KET_090IWP_05F_Gr_2

M10

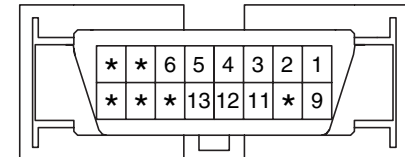

MLX_OBDIIL_16F_B_SIN

M15-A

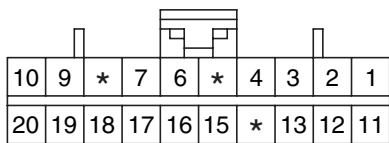

AMP_040M2_20F_B

M15-B

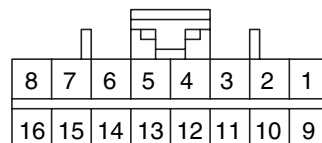

AMP_040M2_16F_B

M20-3

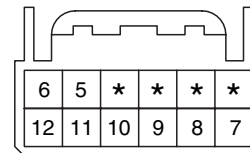

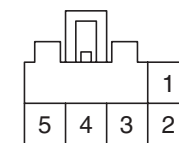

AMP_025_12F_W

M21

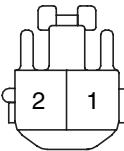

KUM_CDR_05F_W

STARTING SYSTEM

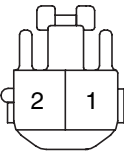
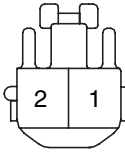
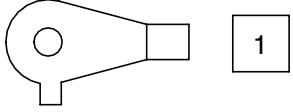
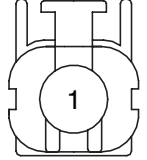
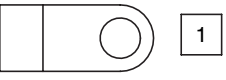
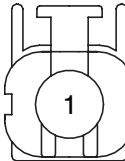
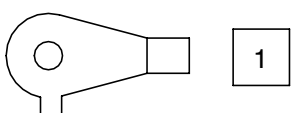
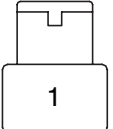
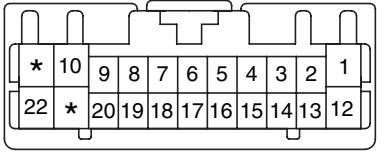
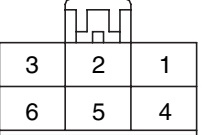
STARTING SYSTEM (2)			SD360-2
<p>C08</p>  <p>KET_SSD_10F_B_A</p>	<p>C55</p>  <p>KET_090III_02F_W_L</p>	<p>C208</p>  <p>KET_SSD_10F_B_A</p>	<p>C255</p>  <p>KET_090III_02F_W_L</p>
<p>E05</p>  <p>KET_090III_02F_W_L</p>	<p>E12</p>  <p>CHT_STMTR_8T_N</p>	<p>E13</p>  <p>MG610949-4</p>	<p>E112</p>  <p>CR01F054</p>
<p>E113</p>  <p>MG610949-4</p>	<p>E202</p>  <p>CHT_STMTR_8T_N</p>	<p>E203</p>  <p>KET_250_1F</p>	<p>M13-D</p>  <p>KET_0407_22F_W</p>
<p>M18</p>  <p>KUM_DSD_06F_B</p>	<p>BLANK</p>	<p>BLANK</p>	<p>BLANK</p>

FUEL FILTER HEATING SYSTEM

FUEL FILTER HEATING SYSTEM (DSL) (2)

SD361-2

C225

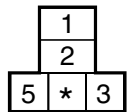

CR05F011

C227

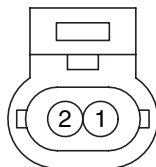

PKD_280WP_02F_B_1

C268

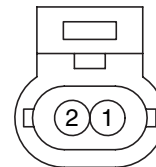

AMP_060WP_02F_B

BLANK

CHARGING SYSTEM (1)

SD373-1

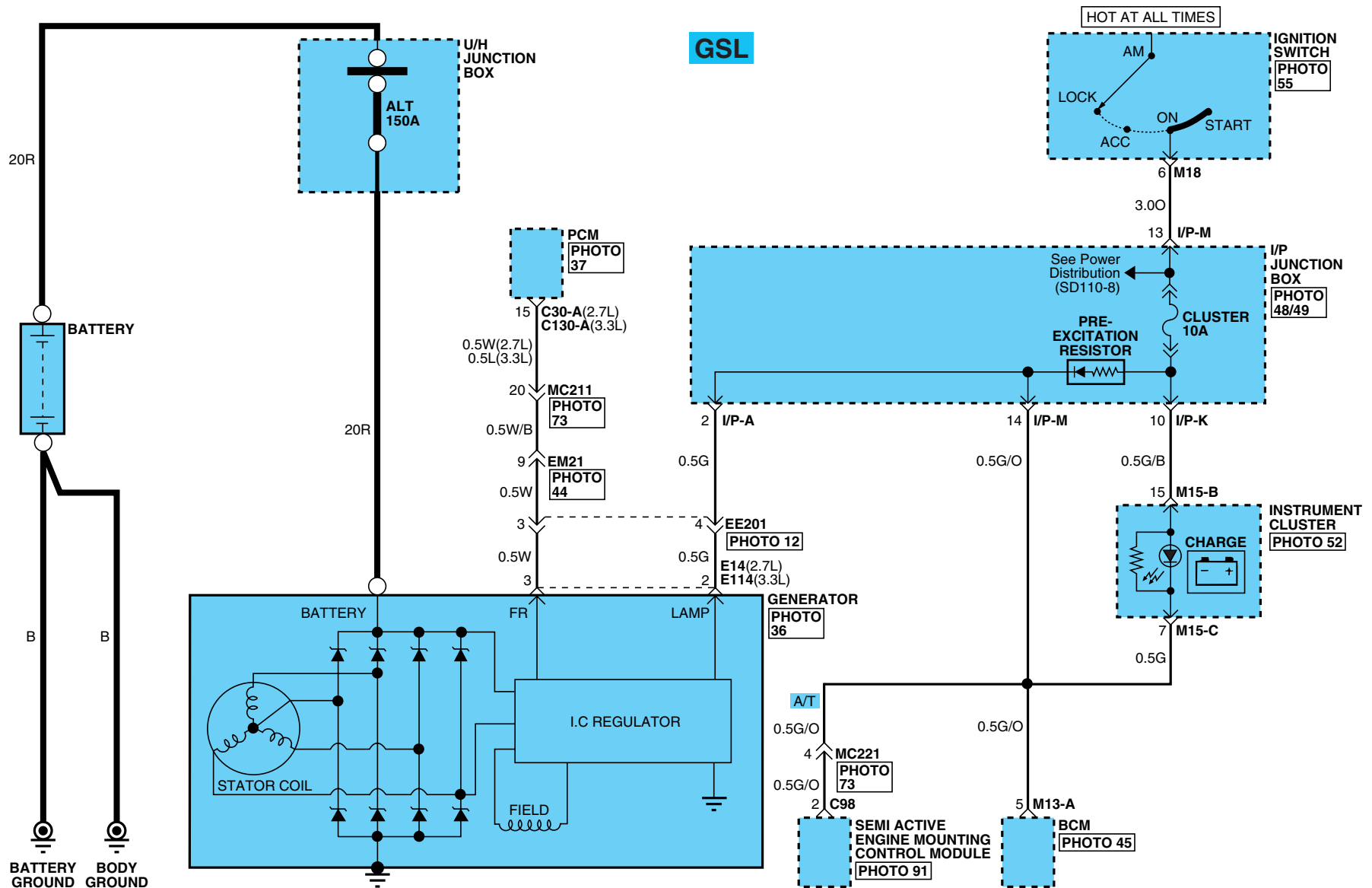

CHARGING SYSTEM

CHARGING SYSTEM (2)

SD373-2

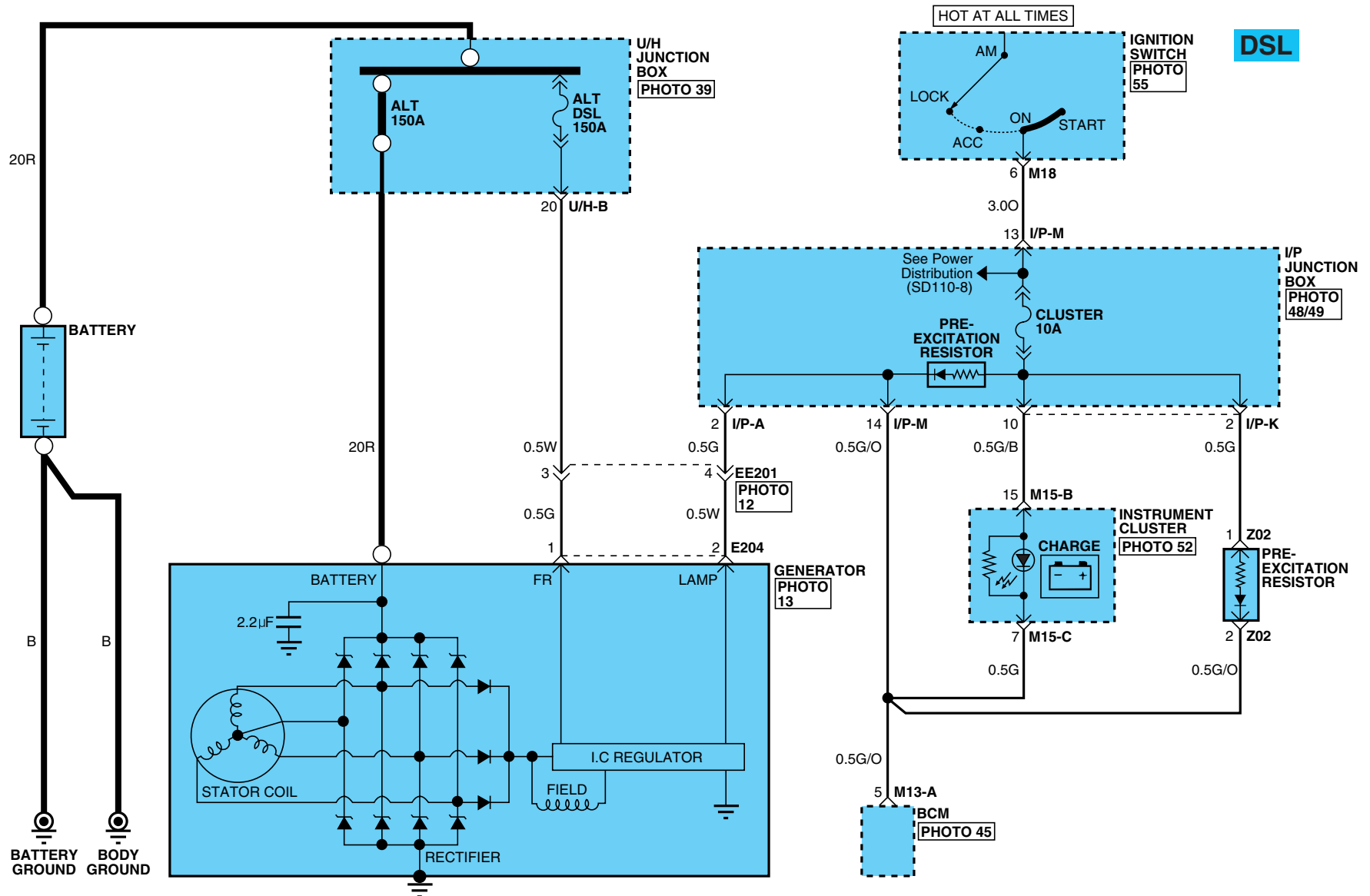

CHARGING SYSTEM

CHARGING SYSTEM (3)

SD373-3

C30-A

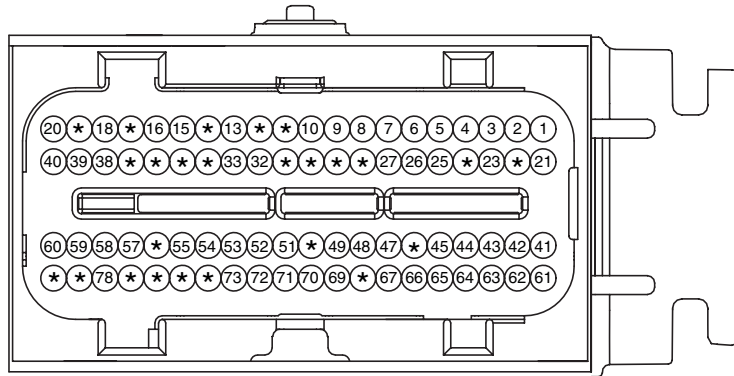

PKD_ECU_80F_Gr_NR

C130-A

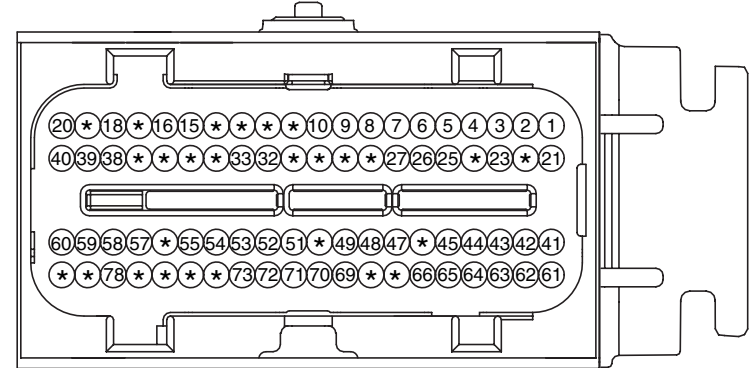

PKD_ECU_80F_Gr_3

C98

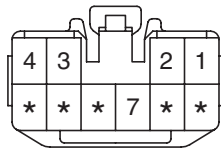

KET_090II_10F_W

E14

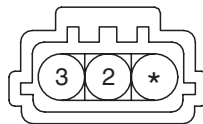

SUMITOMO6189-0443

E114

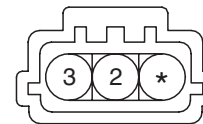

SUMITOMO6189-0443

E204

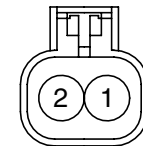

18911-02183

M13-A

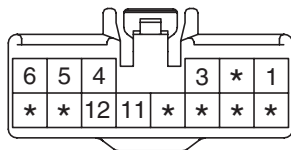

KET_090II_14F_W

M15-B

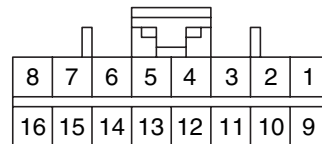

AMP_040M2_16F_B

M15-C

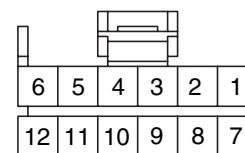

AMP_040M1_12F_B

M18

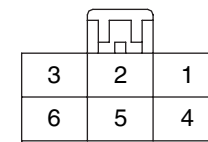

KUM_DSD_06F_B

CHARGING SYSTEM

CHARGING SYSTEM (4)

SD373-4

MEMO

VEHICLE SPEED SENSOR

VEHICLE SPEED SENSOR (2)

SD436-2

C30-A

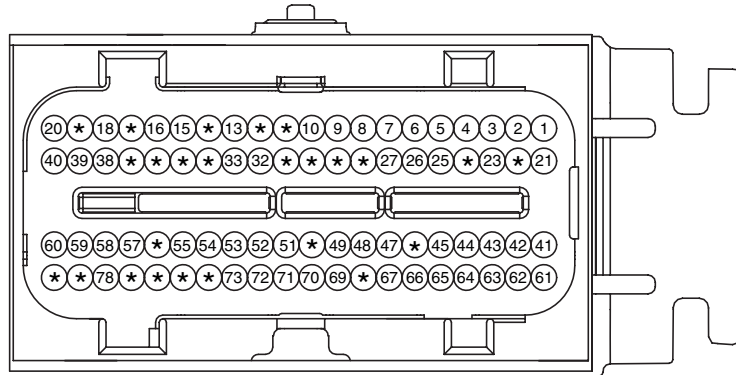

PKD_ECU_80F_Gr_NR

C230-K

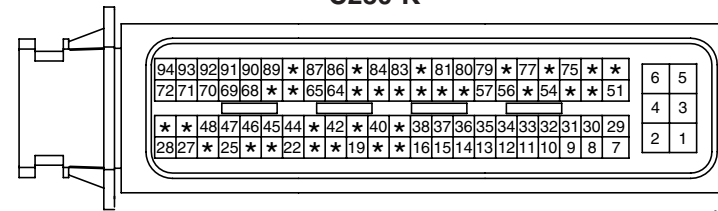

AMP_ECU_94F_B

C246(2.7L/DSL)

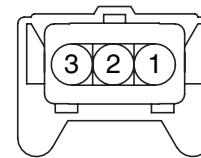

AMP_JPT_03F_B_S1

C270

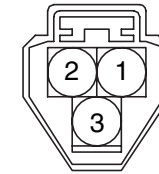

KUM_NMWP_03F_B

F37-A

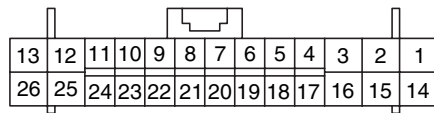

AMP_0407_26F_Gr_HD

M02

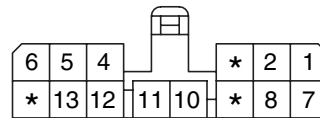

AMP_070_14F_W

M10

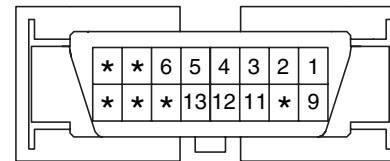

MLX_OBDII_16F_B_SIN

M13-C

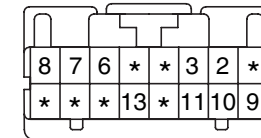

KET_0407_16F_W

M15-A

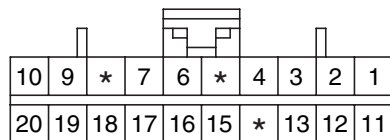

AMP_040M2_20F_B

M41-B

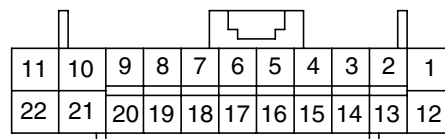

AMP_0407_22F_W_HD

BLANK

BLANK

AUTOMATIC TRANSAXLE CONTROL SYSTEM (DSL 2.2L) (1)

SD450-1

EURO -IV

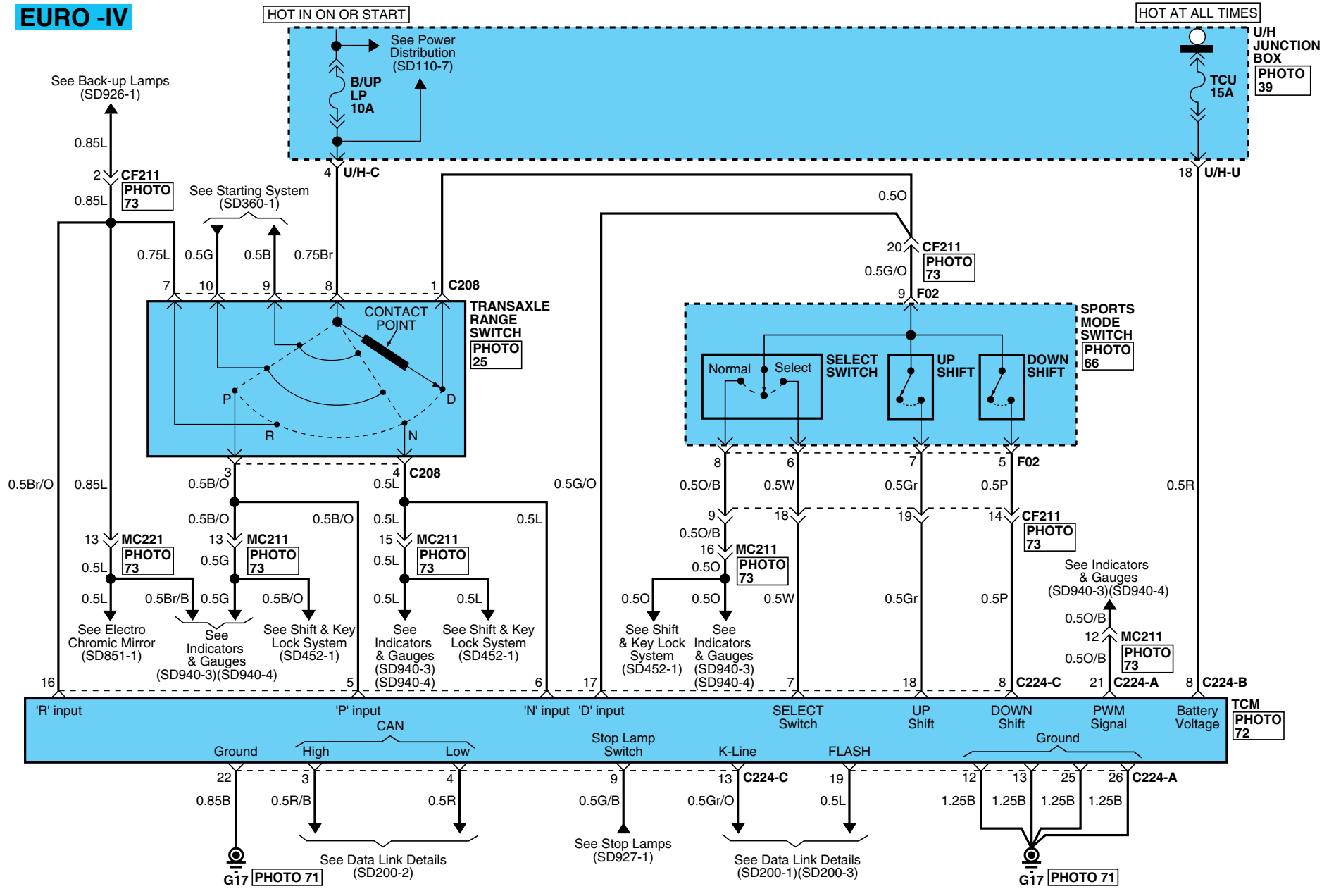

AUTOMATIC TRANSAXLE CONTROL SYSTEM

AUTOMATIC TRANSAXLE CONTROL SYSTEM (DSL 2.2L) (2)

SD450-2

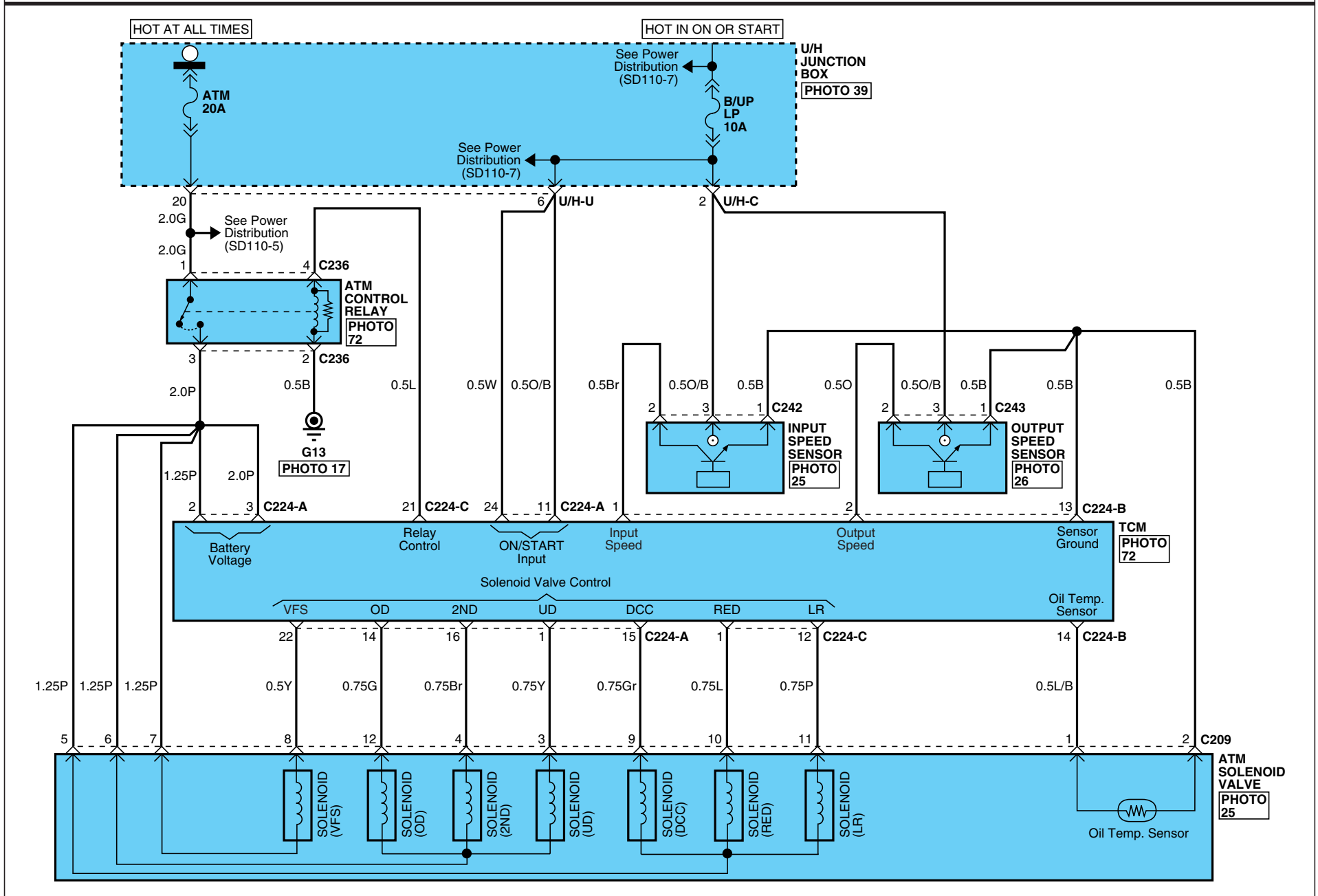

AUTOMATIC TRANSAXLE CONTROL SYSTEM

AUTOMATIC TRANSAXLE CONTROL SYSTEM (DSL 2.2L) (3)

SD450-3

C208



KET_SSD_10F_B_A

C209



KET_SSD_12F_B

C224-A

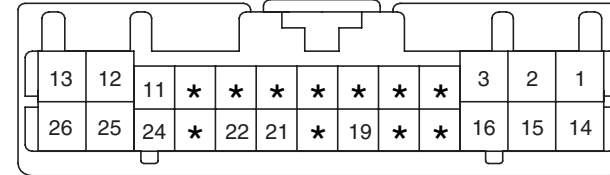

KET_0407_26F_W

C224-B

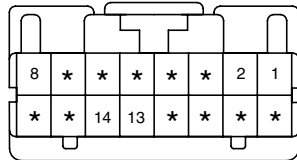

KET_0407_16F_W

C224-C

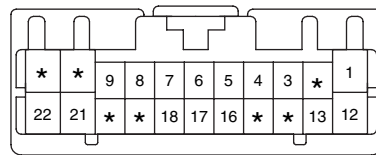

KET_0407_22F_W

C236

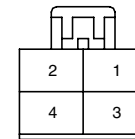

KUM_DSD_04F_W

C242

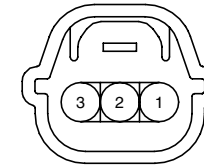

KET_SSD_03F_B_A

C243

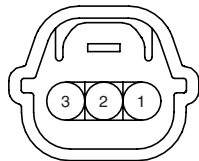

KET_SSD_03F_Gr_B

F02

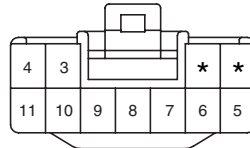

KET_090II_11F_W

BLANK

BLANK

AUTOMATIC TRANSAXLE CONTROL SYSTEM

AUTOMATIC TRANSAXLE CONTROL SYSTEM (DSL 2.2L) (4)

SD450-4

MEMO

AUTOMATIC TRANSAXLE CONTROL SYSTEM

AUTOMATIC TRANSAXLE CONTROL SYSTEM (GSL 2.7L) (2)

SD450-6

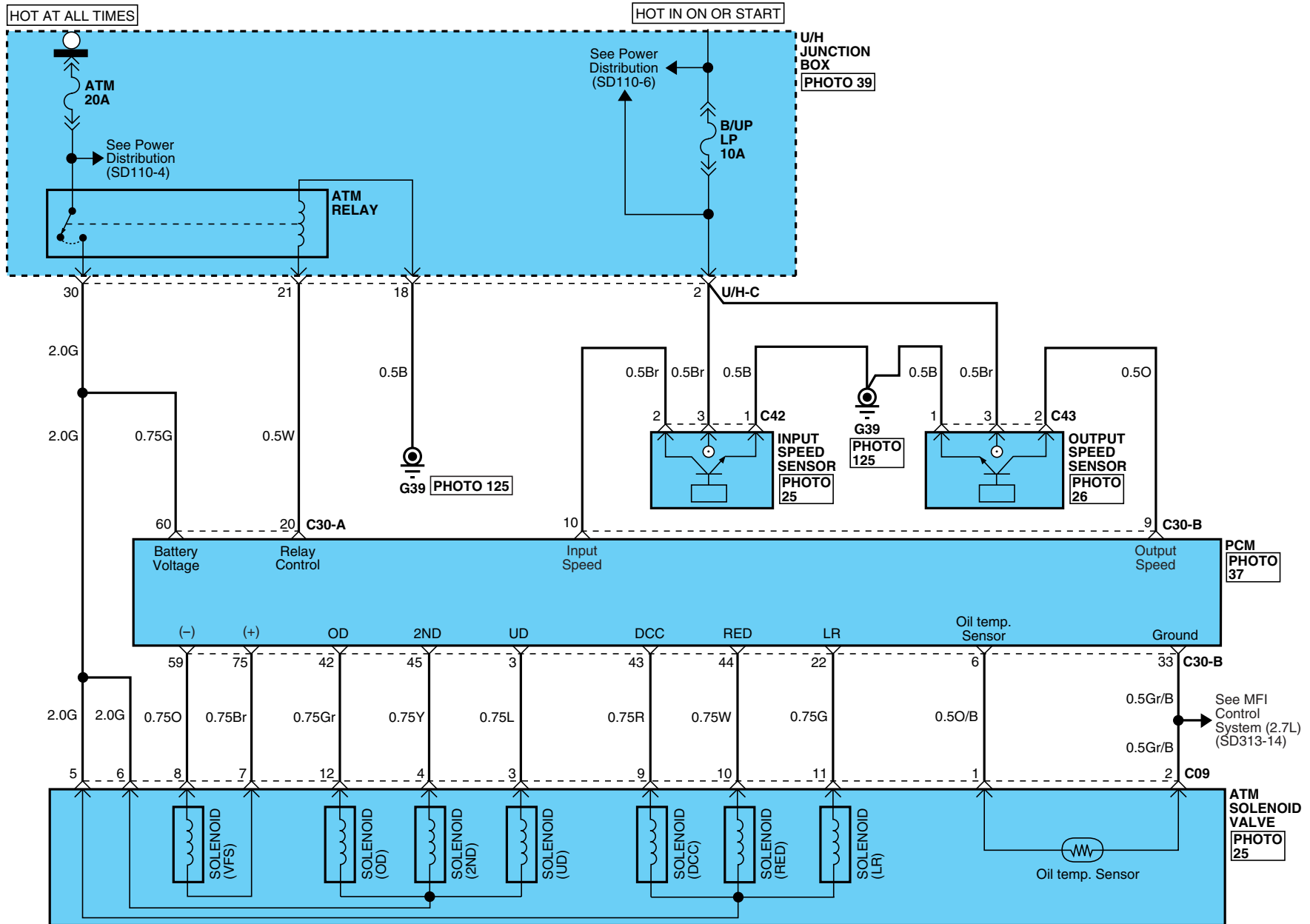

AUTOMATIC TRANSAXLE CONTROL SYSTEM

AUTOMATIC TRANSAXLE CONTROL SYSTEM (GSL 2.7L) (3)

SD450-7

C08

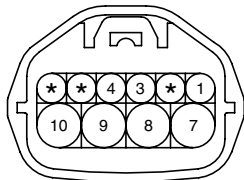

KET_SSD_10F_B_A

C09

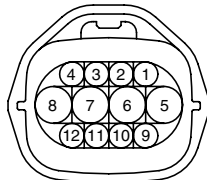

KET_SSD_12F_B

C30-A

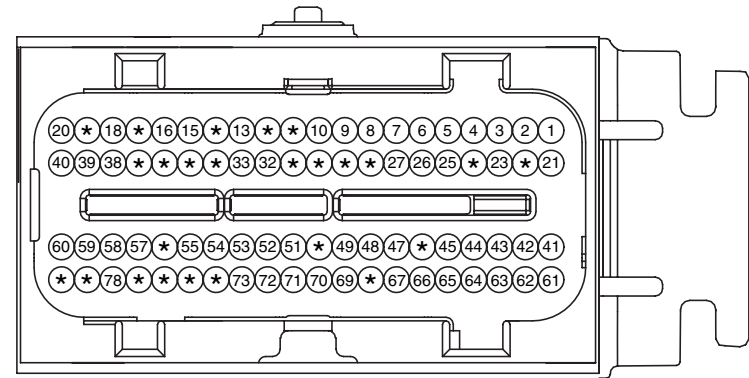

PKD_ECU_80F_Gr_NR

C30-B

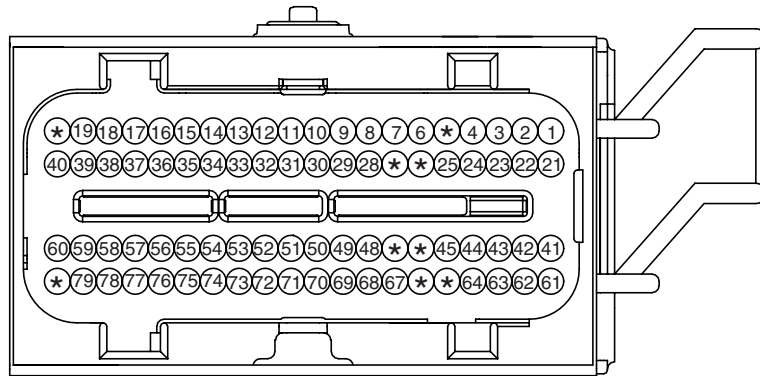

PKD_ECU_80F_B_R

C42

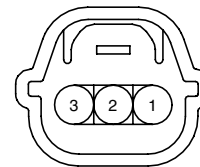

KET_SSD_03F_B_A

C43

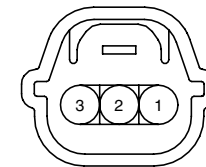

KET_SSD_03F_Gr_B

F02

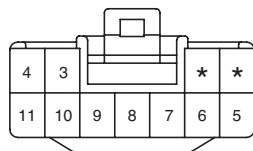

KET_090II_11F_W

BLANK

BLANK

BLANK

AUTOMATIC TRANSAXLE CONTROL SYSTEM

AUTOMATIC TRANSAXLE CONTROL SYSTEM (GSL 2.7L) (4)

SD450-8

MEMO

AUTOMATIC TRANSAXLE CONTROL SYSTEM (GSL 3.3L) (1)

SD450-9

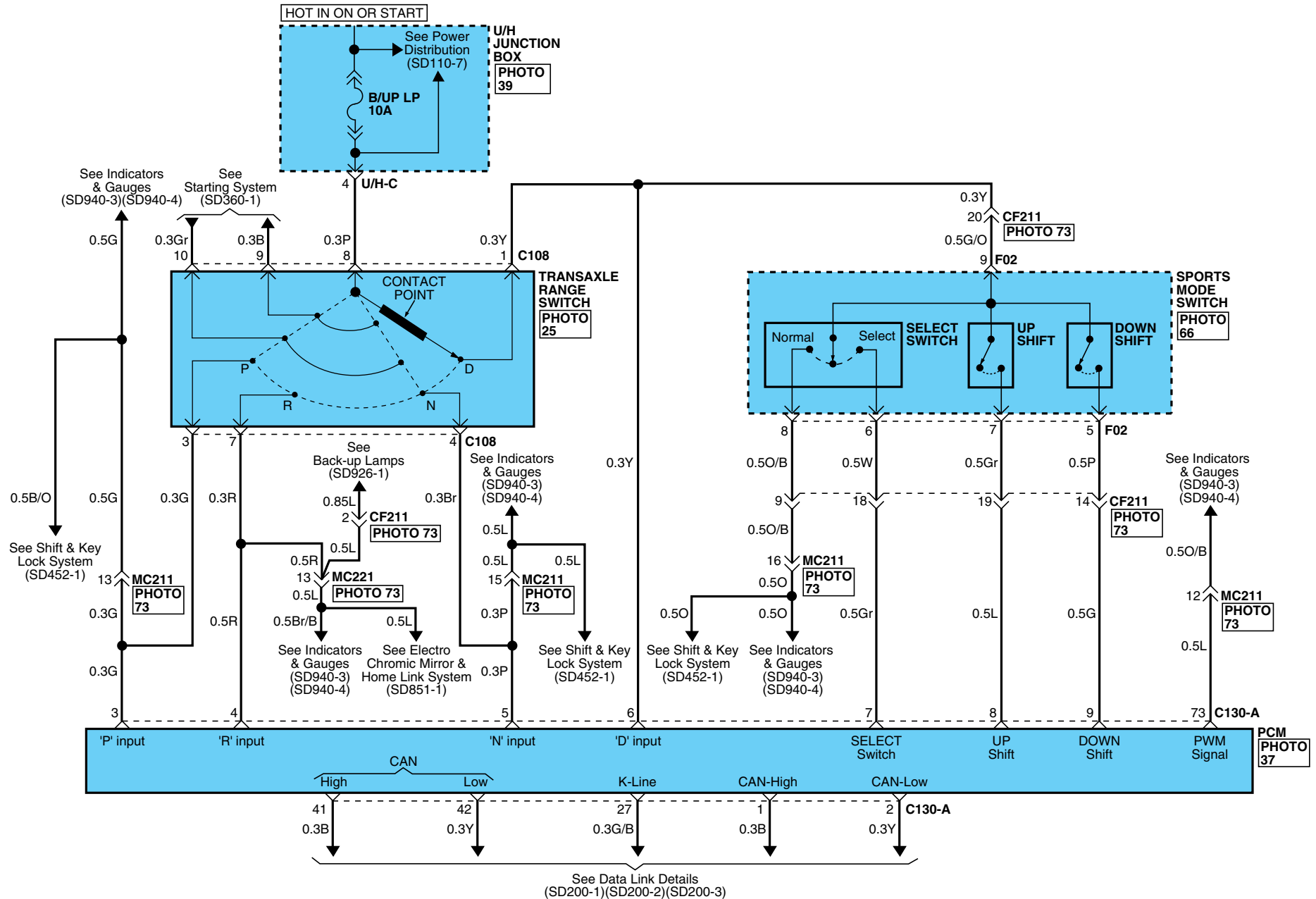

AUTOMATIC TRANSAXLE CONTROL SYSTEM

AUTOMATIC TRANSAXLE CONTROL SYSTEM (GSL 3.3L) (2)

SD450-10

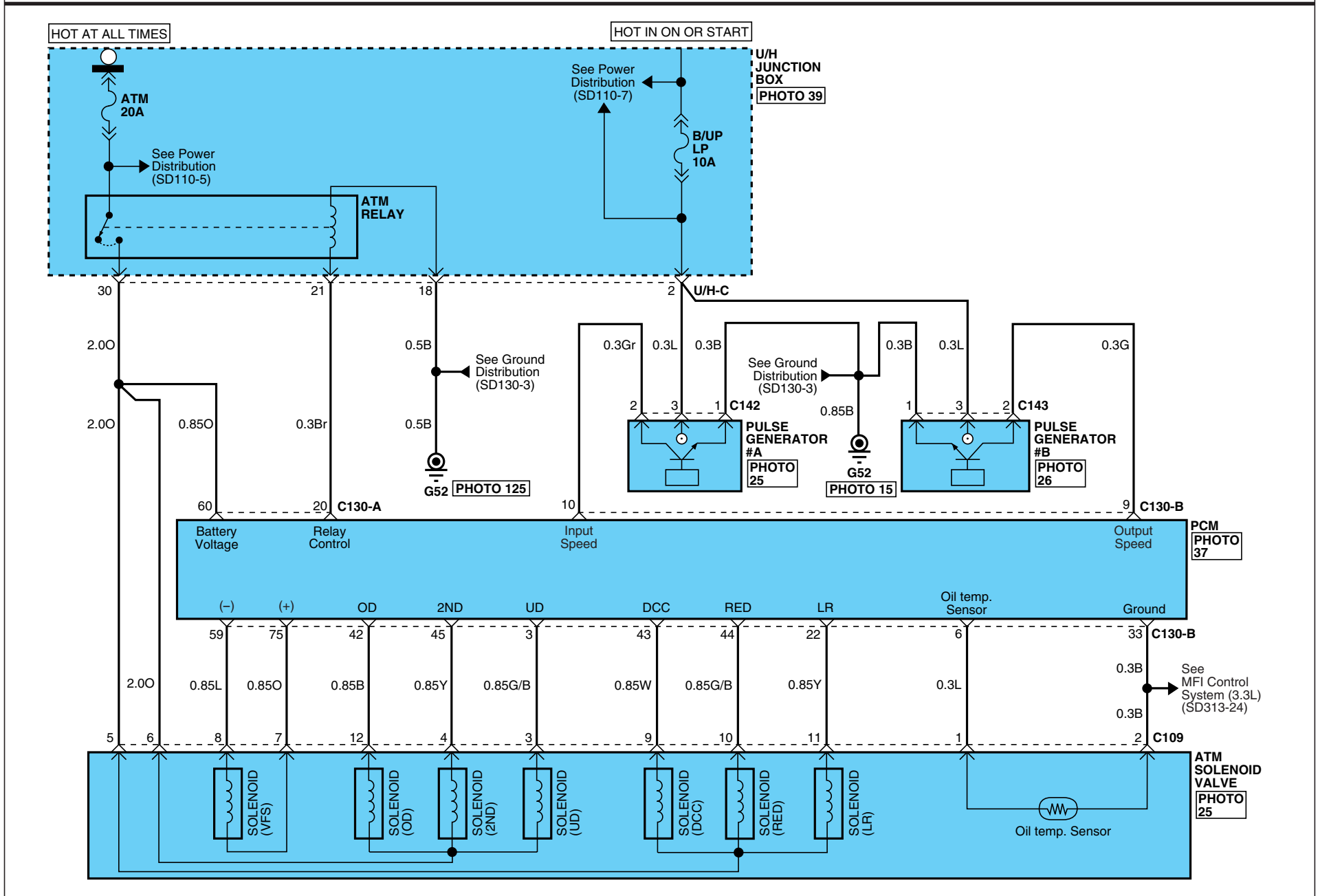

AUTOMATIC TRANSAXLE CONTROL SYSTEM

AUTOMATIC TRANSAXLE CONTROL SYSTEM (GSL 3.3L) (3)

SD450-11

C08



KET_SSD_10F_B_A

C09



KET_SSD_12F_B

C130-A

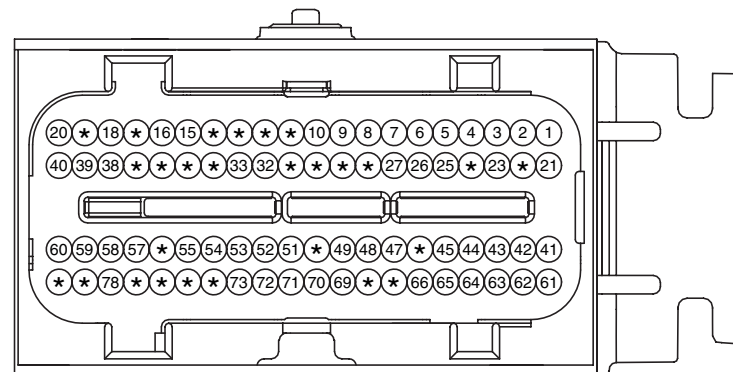

PKD_ECU_80F_Gr_3

C130-B

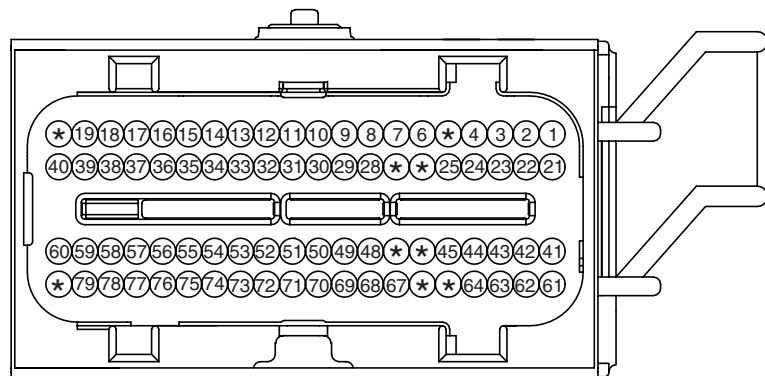

PKD_ECU_80F_B_4

C42

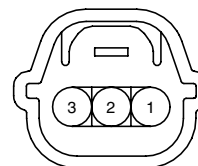

KET_SSD_03F_B_A

C43

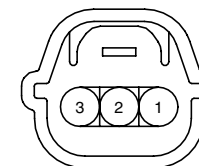

KET_SSD_03F_Gr_B

F02

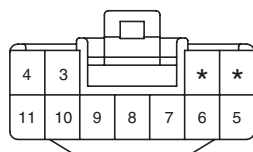

KET_090II_11F_W

BLANK

BLANK

BLANK

AUTOMATIC TRANSAXLE CONTROL SYSTEM

AUTOMATIC TRANSAXLE CONTROL SYSTEM (GSL 3.3L) (4)

SD450-12

MEMO

SHIFT & KEY LOCK SYSTEM (1)

SD452-1

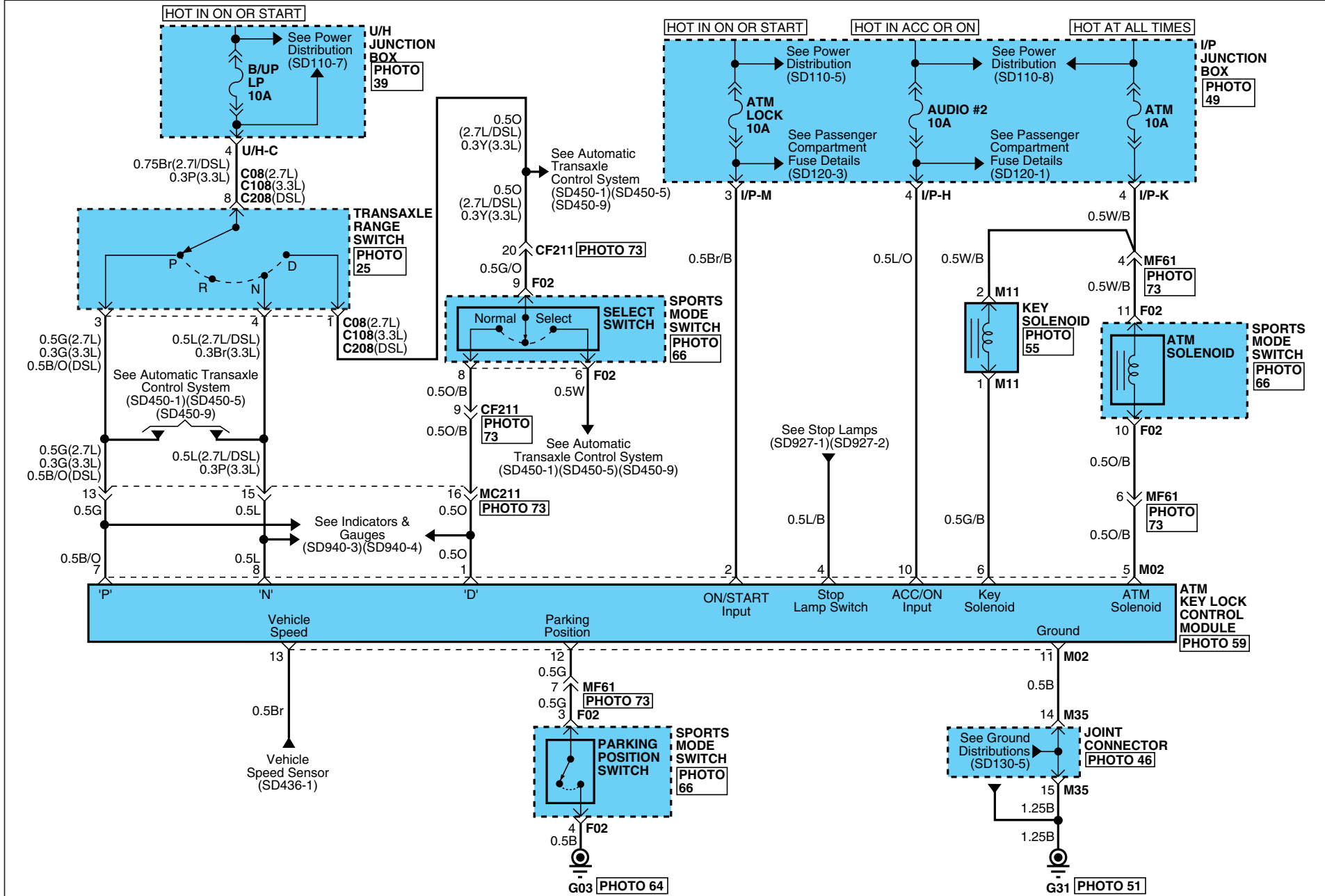

SHIFT & KEY LOCK SYSTEM

SHIFT & KEY LOCK SYSTEM (2)

SD452-2

C08



KET_SSD_10F_B_A

C108



KET_SSD_10F_B_A

C208



KET_SSD_10F_B_A

F02

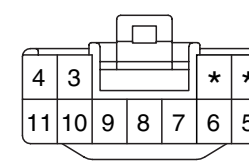

KET_090II_11F_W

M02

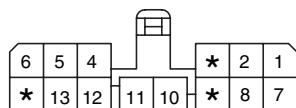

AMP_070_14F_W

M11

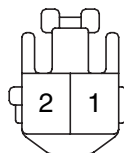

KET_090II_02F_B_R

BLANK

BLANK

ELECTRONIC 4WD CONTROL SYSTEM (1)

SD527-1

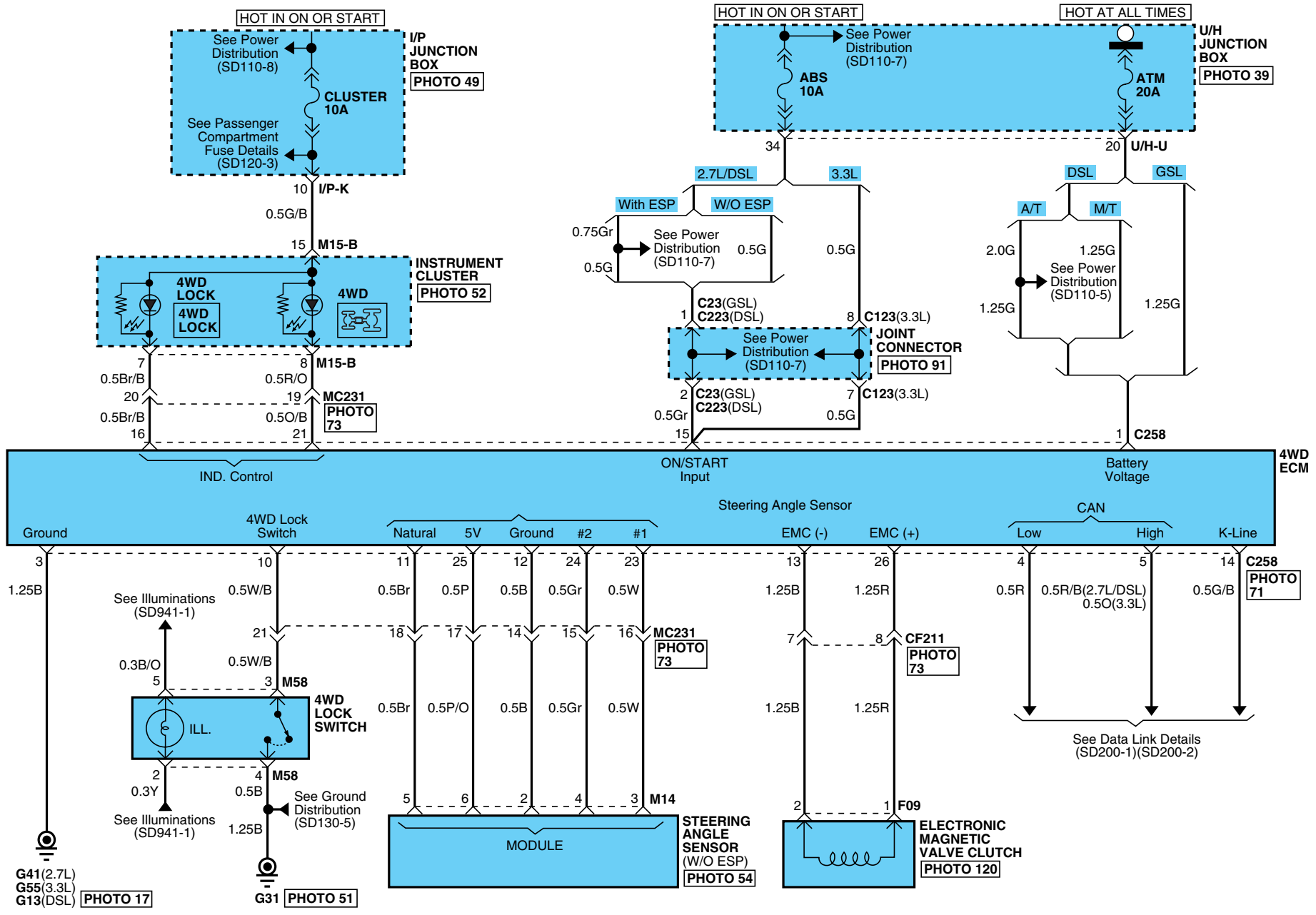

ELECTRONIC 4WD CONTROL SYSTEM

ELECTRONIC 4WD CONTROL SYSTEM (2)

SD527-2

C258(2.7L/DSL)

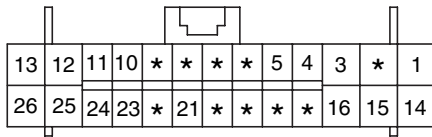

AMP_0407_26F_W_HD

C258(3.3L)

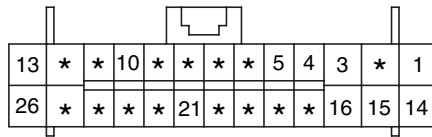

AMP_0407_26F_W_HD

F09

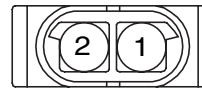

PKD_MP150A_02F_GR

M14

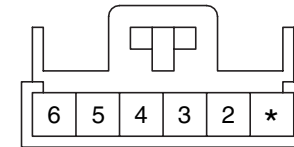

AMP_070_06F_W_1F

M15-B

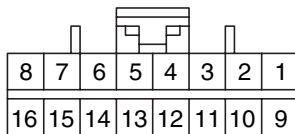

AMP_040M2_16F_B

M58

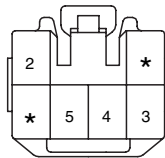

KET_090I1_06F_L

BLANK

BLANK

AIR BAG SYSTEM (SRS)

AIR BAG SYSTEM (SRS) (2)



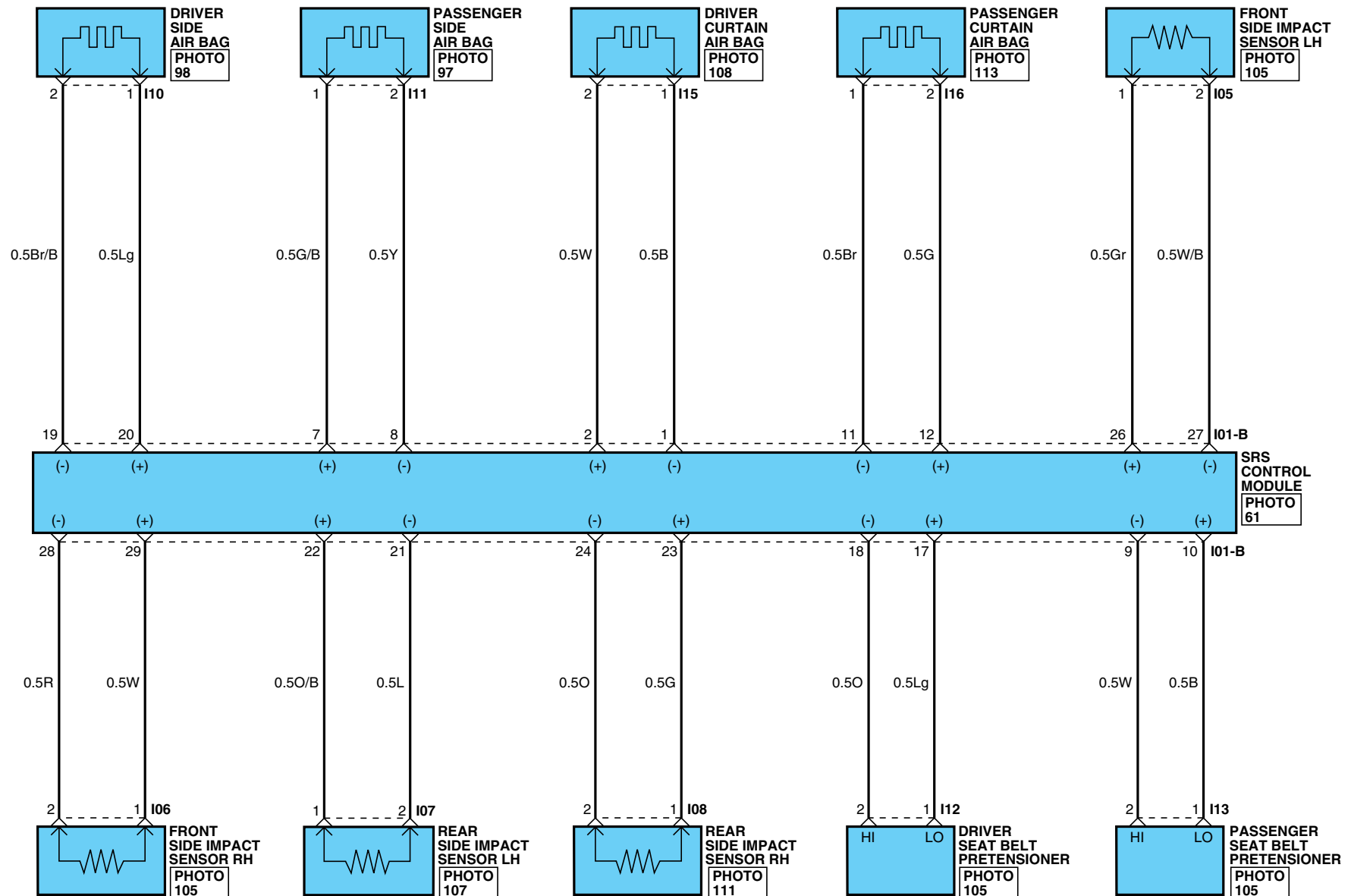









SD569-2

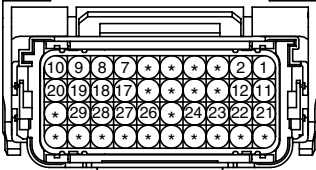
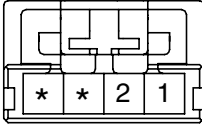
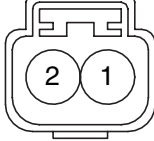

AIR BAG SYSTEM (SRS)

AIR BAG SYSTEM (SRS) (3)

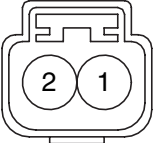
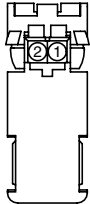
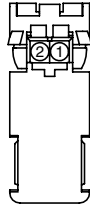
SD569-3

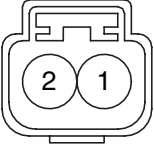
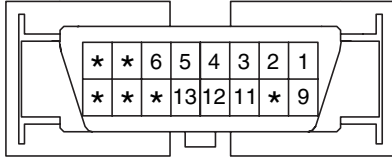
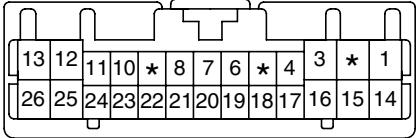
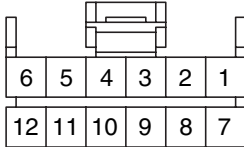
<p>C250 (GSL)</p>  <p>SUM_060WP_02F_B</p>	<p>C250 (DSL)</p>  <p>SUM_060WP_02F_B_1</p>	<p>E04</p>  <p>SUM_060WP_02F_B_1</p>	<p>I01-A</p>  <p>AMP_ACU_24F_B</p>
<p>I01-B</p>  <p>AMP_ACU_40F_GR</p>	<p>I02</p>  <p>YAZ_040_04F_Y</p>	<p>I03</p>  <p>YAZ_040WP_02F_Y</p>	<p>I05</p>  <p>SUM_060WP_02F_B_2</p>
<p>I06</p>  <p>SUM_060WP_02F_B_2</p>	<p>I07</p>  <p>SUM_060WP_02F_B_2</p>	<p>I08</p>  <p>SUM_060WP_02F_B_2</p>	<p>I10</p>  <p>YAZ_040WP_02F_Y</p>
<p>I11</p>  <p>YAZ_040WP_02F_Y</p>	<p>I12</p>  <p>AMP_SQUIB_02F_Y</p>	<p>I13</p>  <p>AMP_SQUIB_02F_Y</p>	<p>I15</p>  <p>YAZ_040WP_02F_Y</p>
<p>I16</p>  <p>YAZ_040WP_02F_Y</p>	<p>M10</p>  <p>MLX_OBDII_16F_B_SIN</p>	<p>M13-B</p>  <p>KET_0407_26F_W</p>	<p>M15-C</p>  <p>AMP_040M1_12F_B</p>

AIR BAG SYSTEM (SRS)

AIR BAG SYSTEM (SRS) (4)

SD569-4

M47

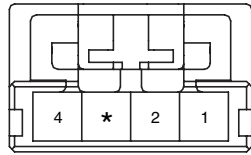

AMP_MQS_04F_B_040

E38



SUM_060WP_02F_B_1

E39



SUM_060WP_02F_B_1

BLANK

ABS CONTROL SYSTEM (1)

SD587-1

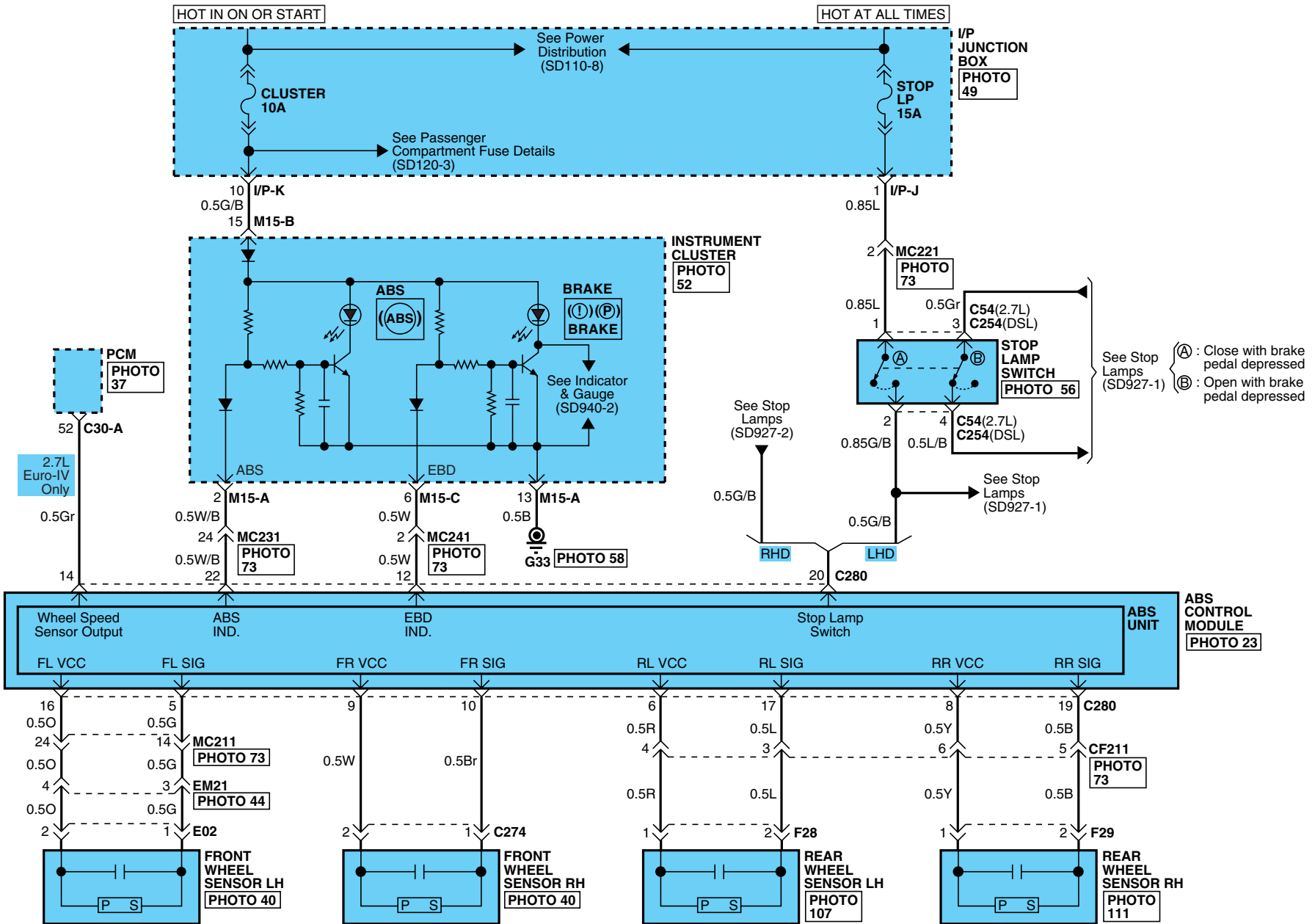

ABS CONTROL SYSTEM

ABS CONTROL SYSTEM (3)

SD587-3

C30-A

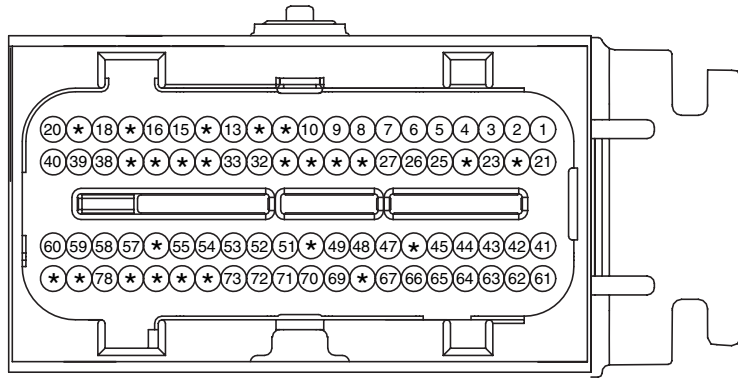

PKD_ECU_80F_Gr_NR

C54

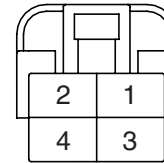

KET_250DL_04F_W

C245(DSL)

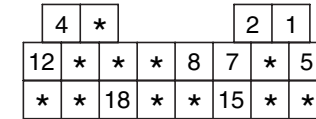

KET_DIAGNOSIS_20F_B_A

C245(GSL)

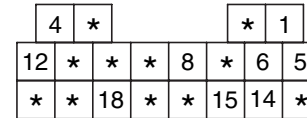

KET_DIAGNOSIS_20F_B_A

C254

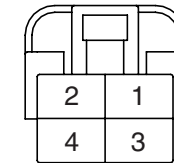

KET_250DL_04F_W

C274

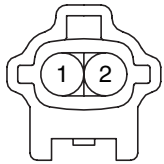

KET_090IWP_02M_B

C280(2.7L)

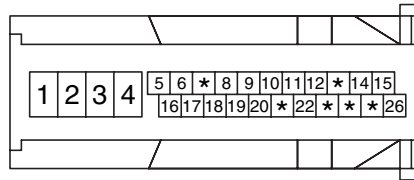

BOS_ABS_26F_B_L

C280(DSL)

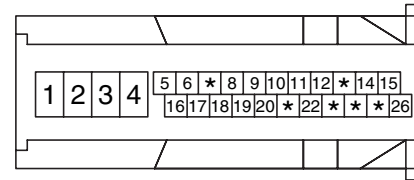

BOS_ABS_26F_B_L

E02

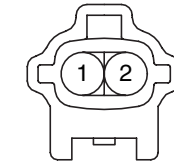

KET_090IWP_02M_B

F28

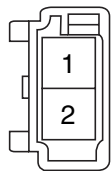

KET_090II_02M_W_SPK

F29

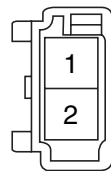

KET_090II_02M_W_SPK

M10

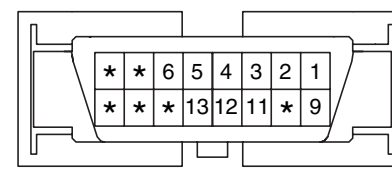

MLX_OBDII_16F_B_SIN

M15-A

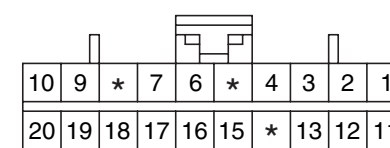

AMP_040M2_20F_B

M15-B

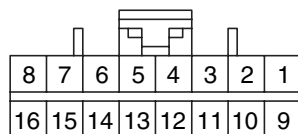

AMP_040M2_16F_B

M15-C

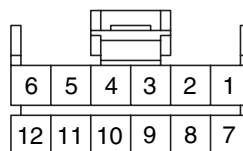

AMP_040M1_12F_B

BLANK

BLANK

ABS CONTROL SYSTEM

ABS CONTROL SYSTEM (4)

SD587-4

MEMO

ESP (ELECTRONIC STABILITY PROGRAM) SYSTEM (1)

SD589-1

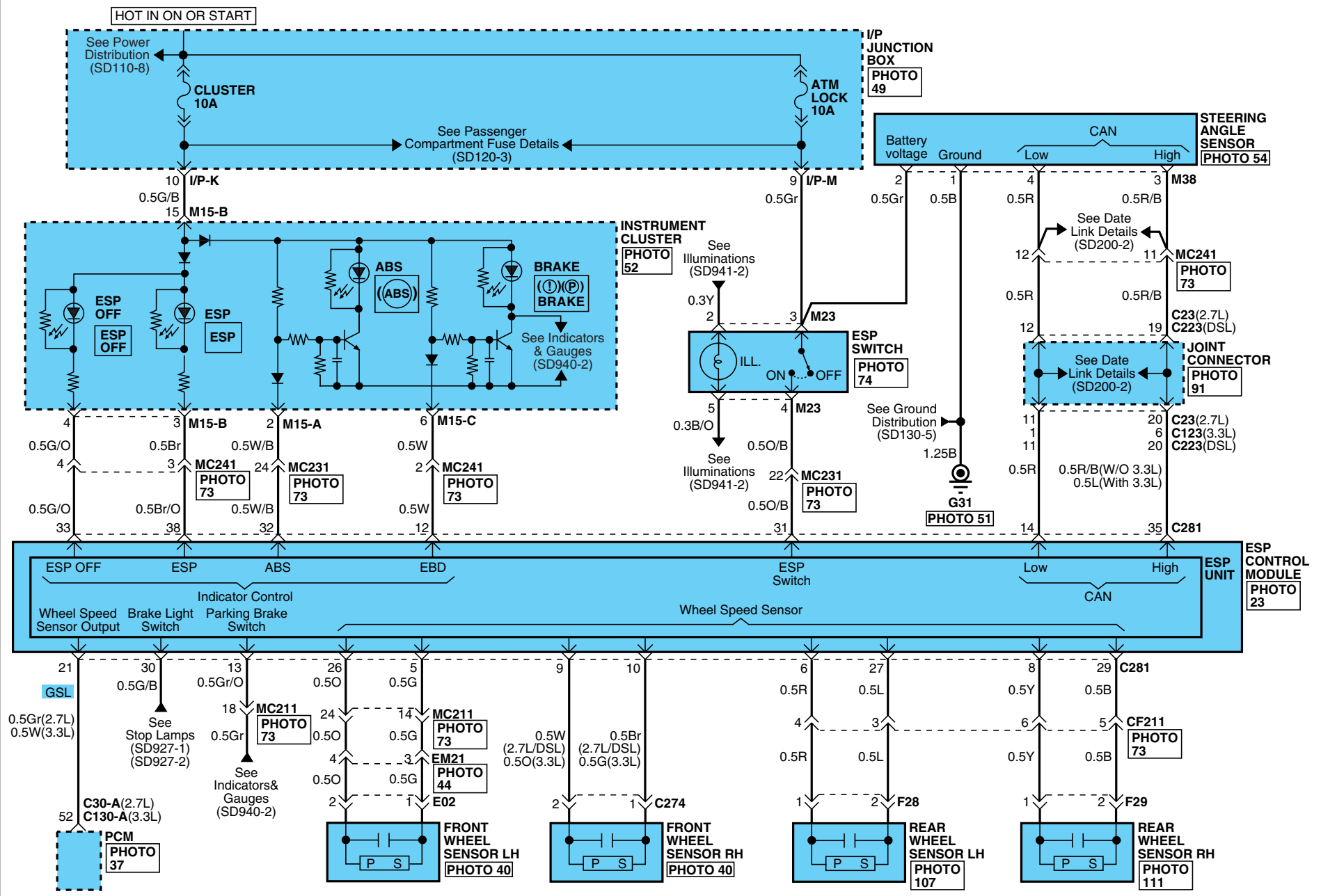

ESP (ELECTRONIC STABILITY PROGRAM) SYSTEM

ESP (ELECTRONIC STABILITY PROGRAM) SYSTEM (4)

SD589-4

M15-A

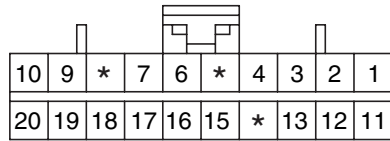

AMP_040M2_20F_B

M15-B

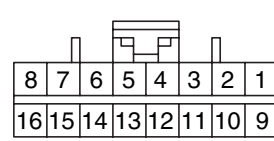

AMP_040M2_16F_B

M15-C

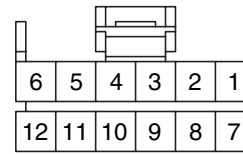

AMP_040M1_12F_B

M23

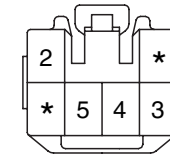

KET_090I1_06F_Gr

M38

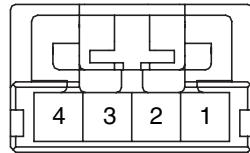

AMP_MQS_04F_B_040

BLANK

BLANK

BLANK

POWER DOOR LOCKS (1)

SD813-1

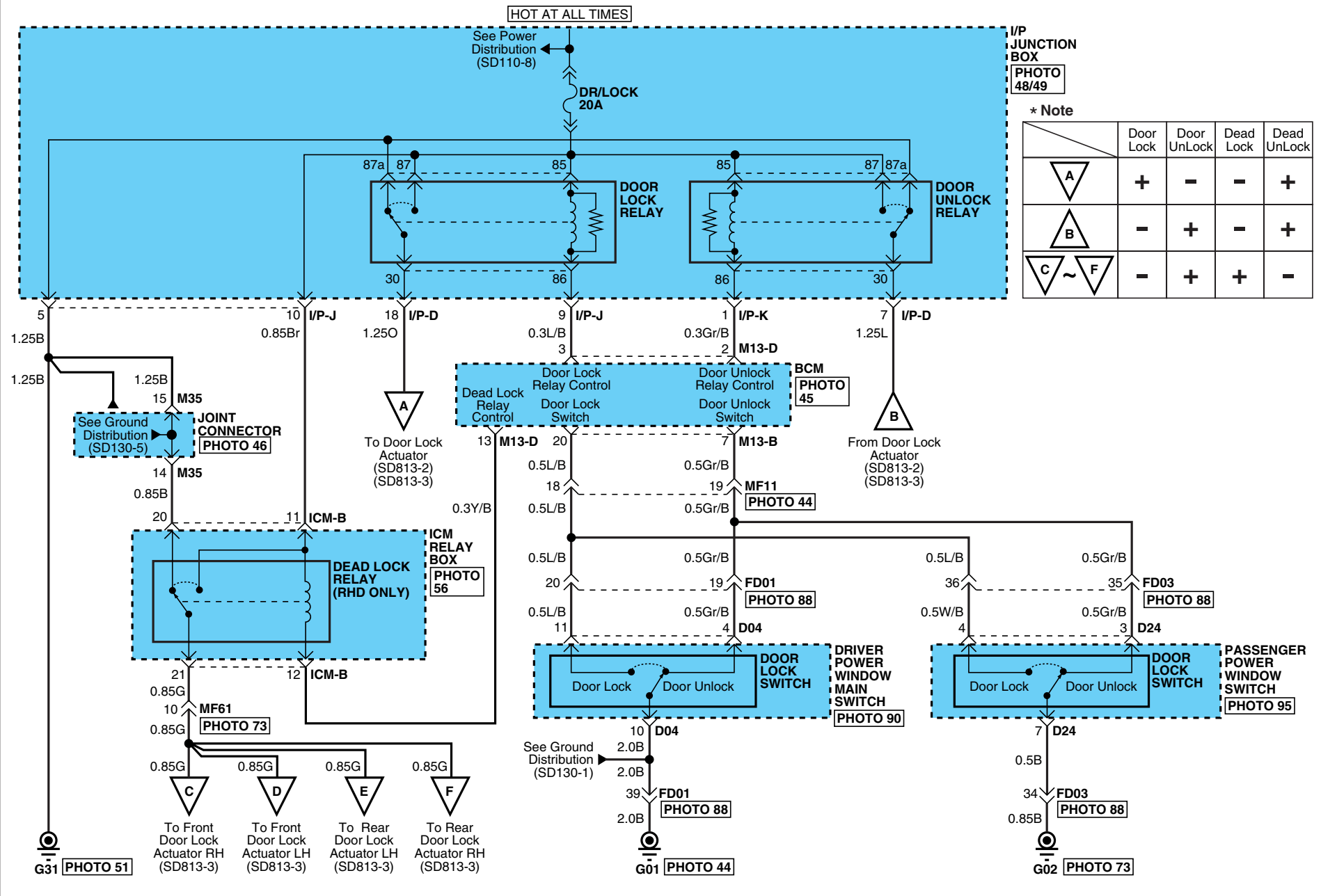

*** Note**

	Door Lock	Door UnLock	Dead Lock	Dead UnLock
A	+	-	-	+
B	-	+	-	+
C ~ F	-	+	+	-

POWER DOOR LOCKS

POWER DOOR LOCKS (3)

SD813-3

With Dead Lock Only RHD

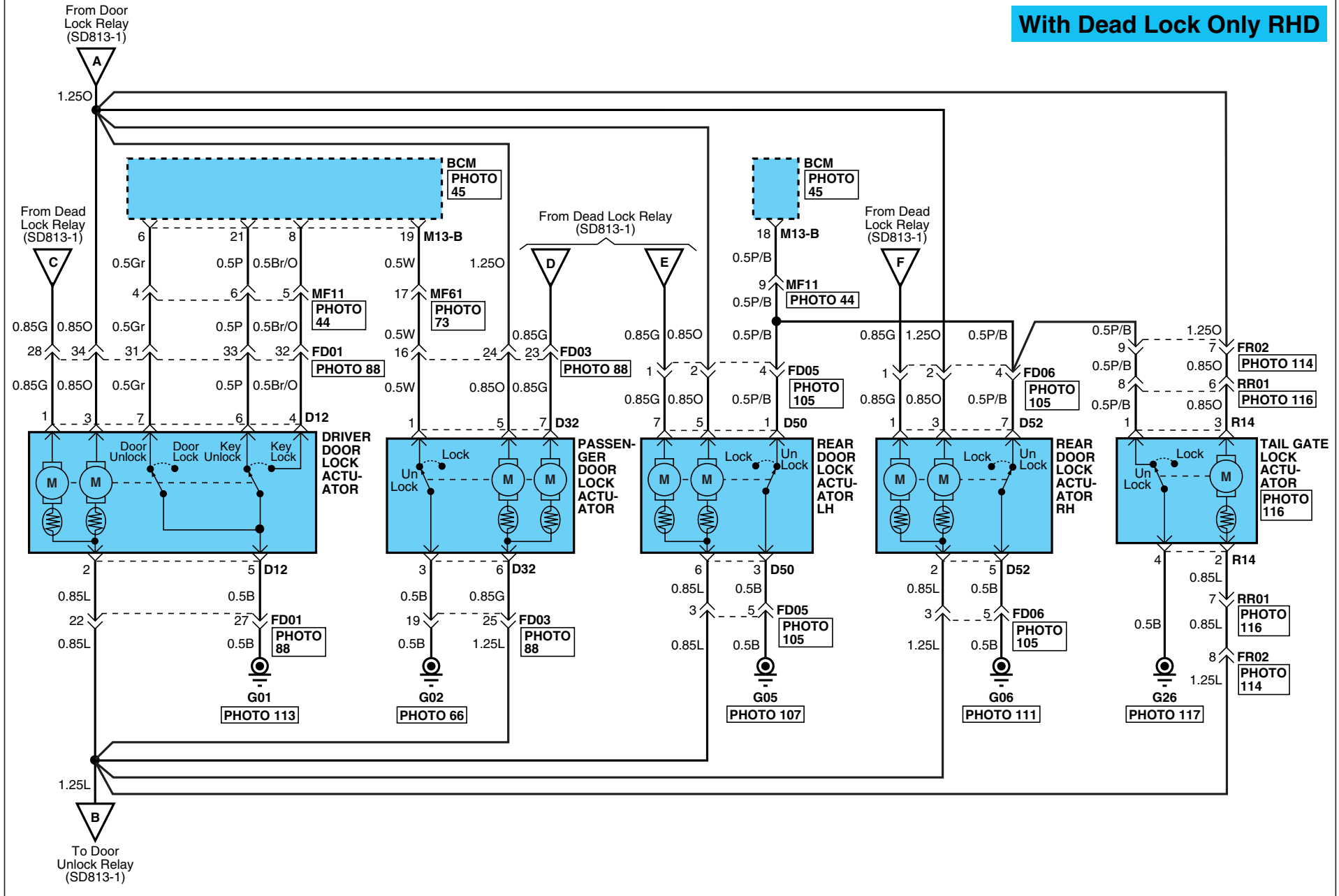

POWER DOOR LOCKS

POWER DOOR LOCKS (4)

SD813-4

D02

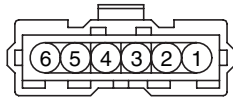

FCI_SENSOR_06F_B

D02A

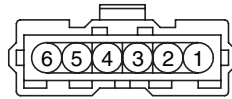

FCI_SENSOR_06F_B

D04

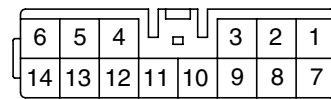

KET_090II_14F_W

D12

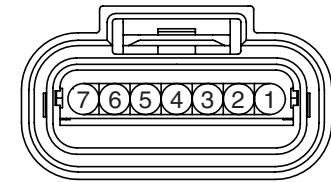

AMP_025WP_07F_B

D22

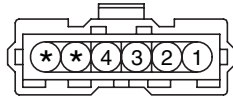

FCI_SENSOR_06F_B

D22A

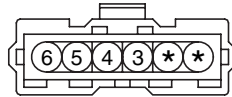

FCI_SENSOR_06F_B

D24

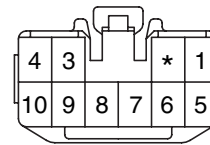

KET_090II_10F_W

D32

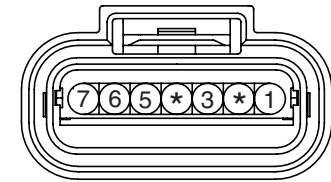

AMP_025WP_07F_B

D42

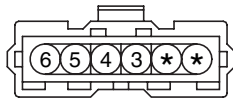

FCI_SENSOR_06F_B

D48

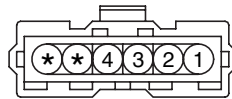

FCI_SENSOR_06F_B

D50

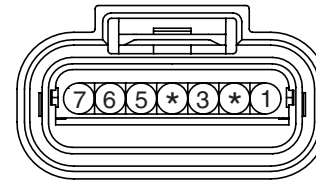

AMP_025WP_07F_B

D52

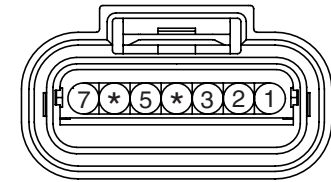

AMP_025WP_07F_B

ICM-B

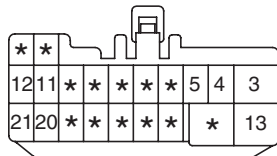

KET_1809_21F_W_A

M13-B

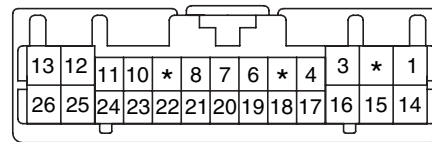

KET_0407_26F_W

M13-D

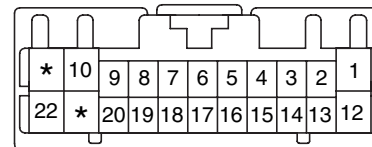

KET_0407_22F_W

R14

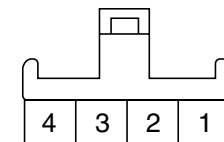

KET_SDL_04F_W

KEYLESS ENTRY & BURGLAR ALARM SYSTEM

KEYLESS ENTRY & BURGLAR ALARM SYSTEM (2)

SD814-2

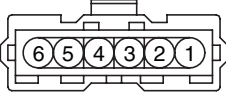
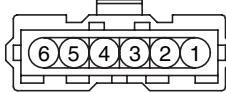
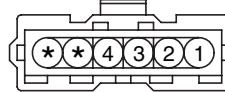
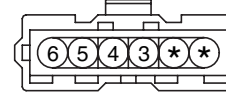
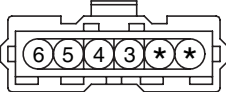
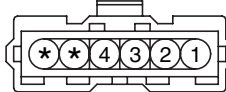
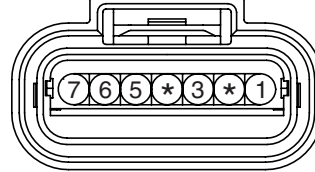
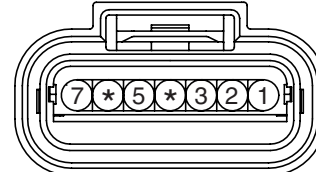
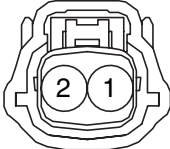
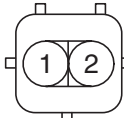
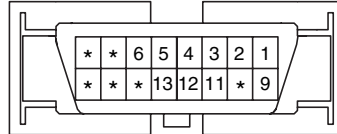
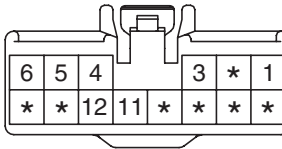
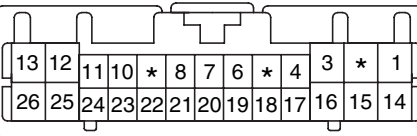
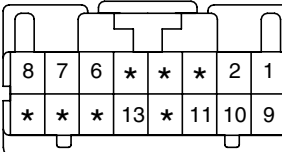
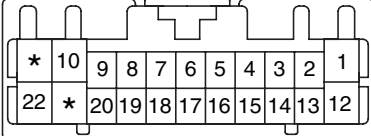
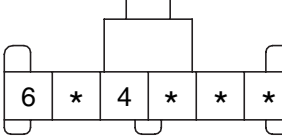
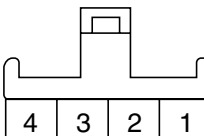
<p>D02</p>  <p>FCI_SENSOR_06F_B</p>	<p>D02A</p>  <p>FCI_SENSOR_06F_B</p>	<p>D22</p>  <p>FCI_SENSOR_06F_B</p>	<p>D22A</p>  <p>FCI_SENSOR_06F_B</p>
<p>D42</p>  <p>FCI_SENSOR_06F_B</p>	<p>D48</p>  <p>FCI_SENSOR_06F_B</p>	<p>D50</p>  <p>AMP_025WP_07F_B</p>	<p>D52</p>  <p>AMP_025WP_07F_B</p>
<p>E03</p>  <p>MLX_HORN_02F_B_FILT</p>	<p>E29</p>  <p>AMP_EJWP_02M_B</p>	<p>M10</p>  <p>MLX_OBDII_16F_B_SIN</p>	<p>M13-A</p>  <p>KET_090II_14F_W</p>
<p>M13-B</p>  <p>KET_0407_26F_W</p>	<p>M13-C</p>  <p>KET_0407_16F_W</p>	<p>M13-D</p>  <p>KET_0407_22F_W</p>	<p>M44</p>  <p>KET_91A_06F_W</p>
<p>R14</p>  <p>KET_SDL_04F_W</p>	<p>BLANK</p>	<p>BLANK</p>	<p>BLANK</p>

SUNROOF (1)

SD816-1

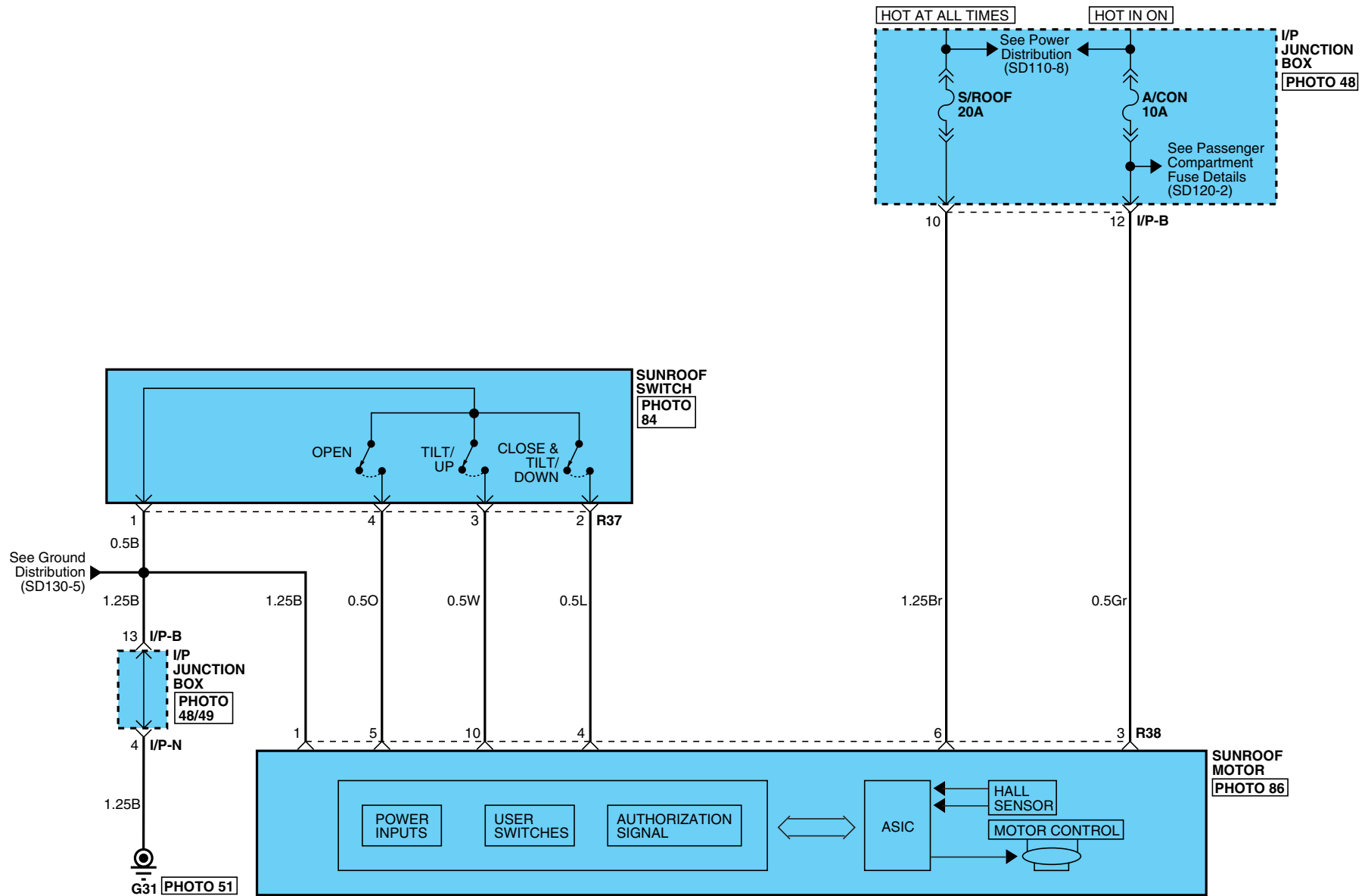

SUNROOF

SUNROOF (2)

SD816-2

R37

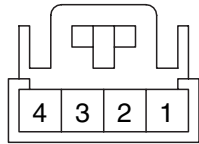

AMP_070_04F_W

R38

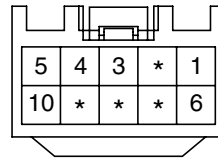

YAZ_1.5SYS_10F_W

BLANK

BLANK

POWER WINDOWS

POWER WINDOWS (3)

SD824-3

D04

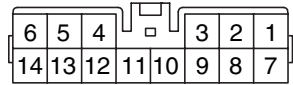

KET_090II_14F_W

D05

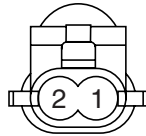

FCI_SNSR_02F_Gr

D24

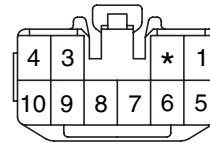

KET_090II_10F_W

D25

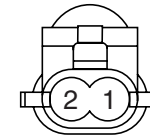

FCI_SNSR_02F_Gr

D43

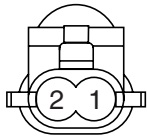

FCI_SNSR_02F_B

D44

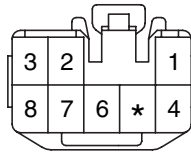

KET_090II_08F_W

D46

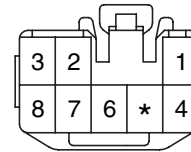

KET_090II_08F_W

D47

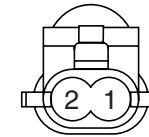

FCI_SNSR_02F_B

M13-D

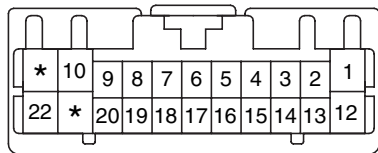

KET_0407_22F_W

BLANK

BLANK

BLANK

POWER WINDOWS

POWER WINDOWS (4)

SD824-4

MEMO

ELECTRO CHROMIC MIRROR & COMPASS SYSTEM (1)



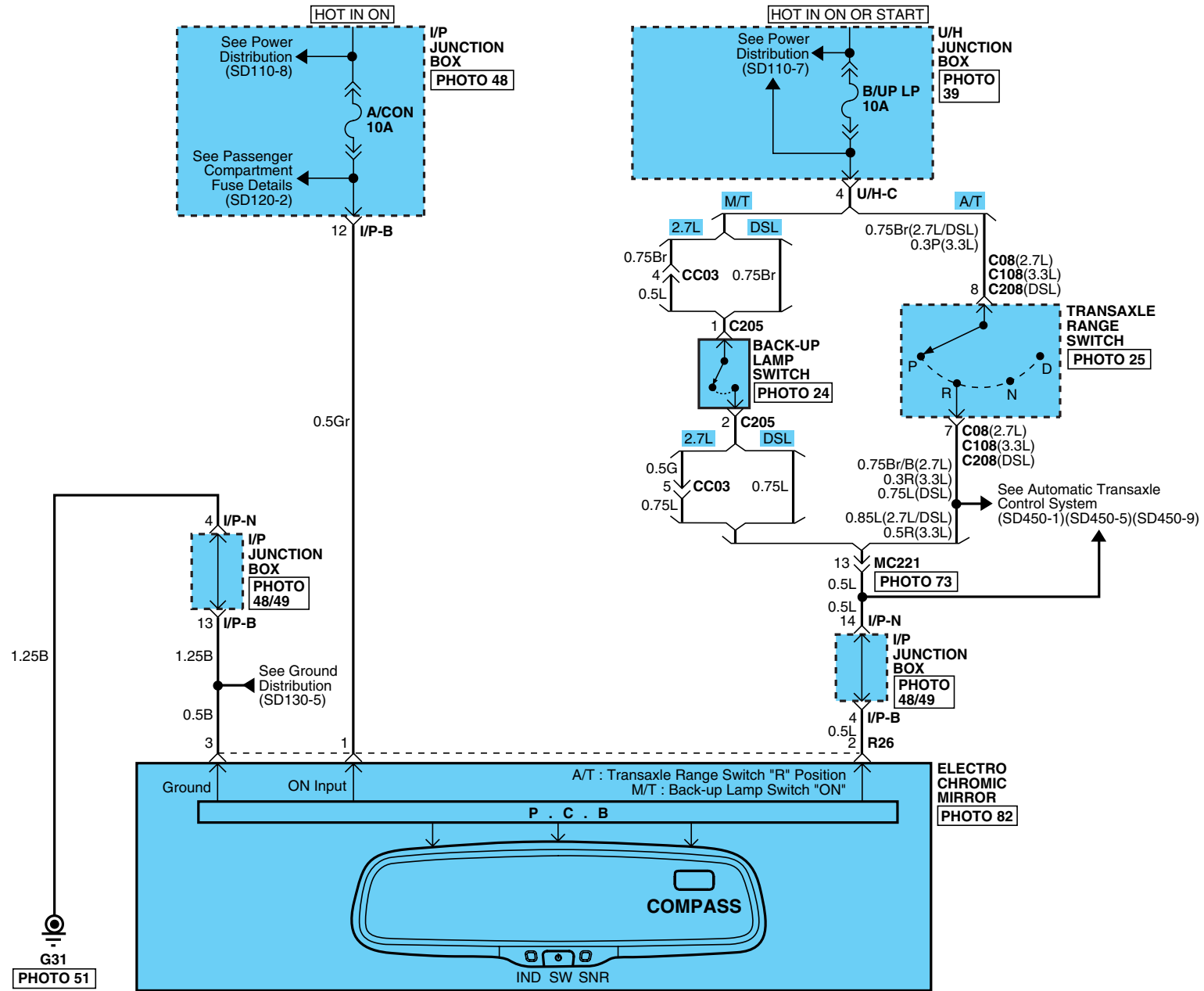

SD851-1



ELECTRO CHROMIC MIRROR & COMPASS SYSTEM

ELECTRO CHROMIC MIRROR & COMPASS SYSTEM (2)

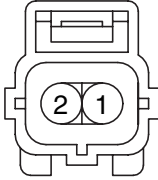
SD851-2

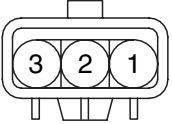
<p style="text-align: center;">C08</p>  <p style="text-align: center;">KET_SSD_10F_B_A</p>	<p style="text-align: center;">C108</p>  <p style="text-align: center;">KET_SSD_10F_B_A</p>	<p style="text-align: center;">C205</p>  <p style="text-align: center;">AMP_EJWP_02F_B</p>	<p style="text-align: center;">C208</p>  <p style="text-align: center;">KET_SSD_10F_B_A</p>
<p style="text-align: center;">R26</p>  <p style="text-align: center;">KET_TLCWP_03F_W</p>	<p style="text-align: center;">BLANK</p>	<p style="text-align: center;">BLANK</p>	<p style="text-align: center;">BLANK</p>

POWER OUTSIDE MIRRORS

E34D9A0D

POWER OUTSIDE MIRRORS (1)

SD876-1

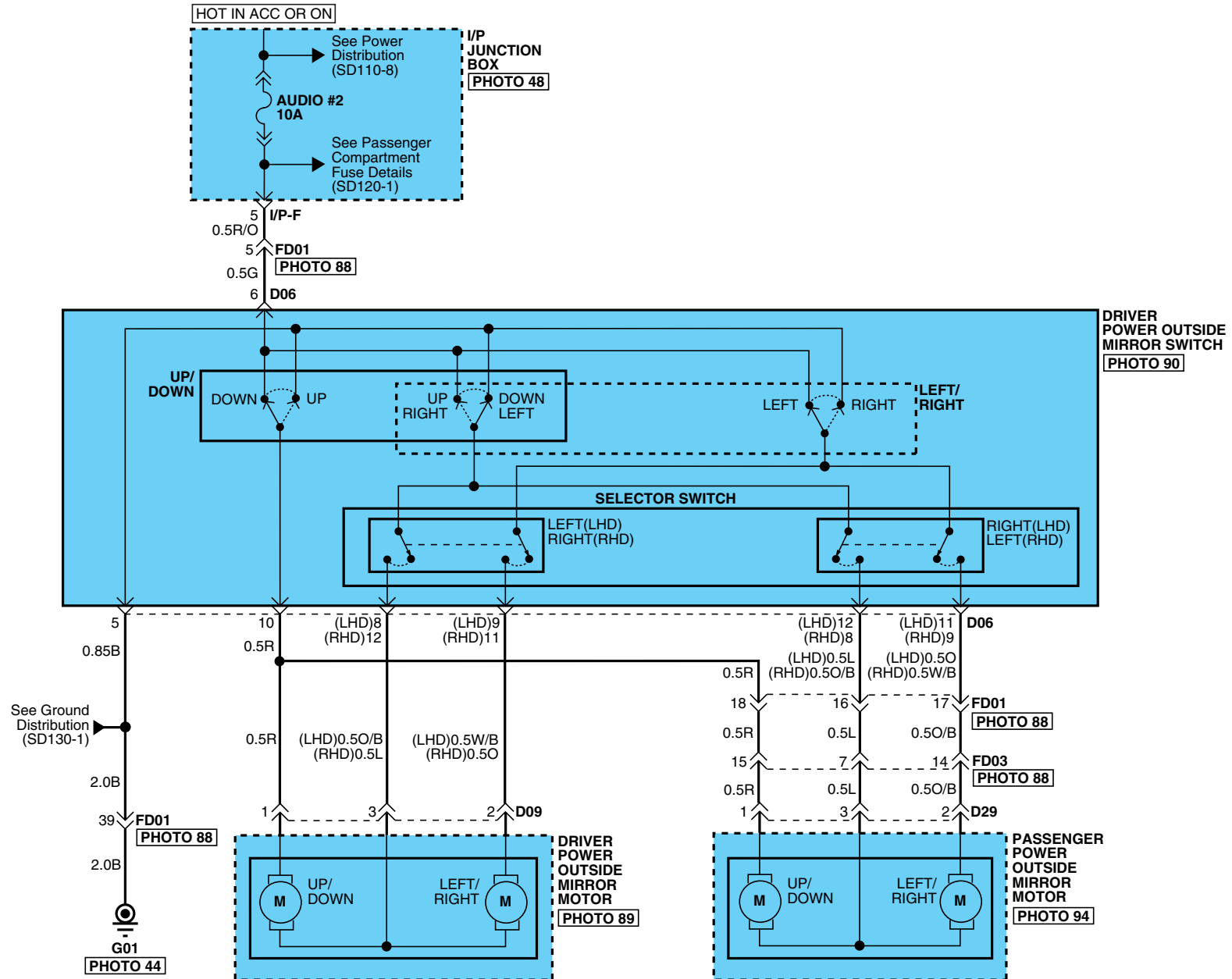

POWER OUTSIDE MIRRORS

POWER OUTSIDE MIRRORS (2)

SD876-2

D06

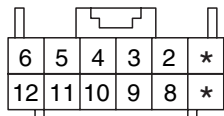

AMP_0407_12F_W_070

D09

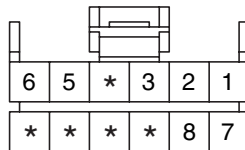

AMP_040M1_12F_B

D29

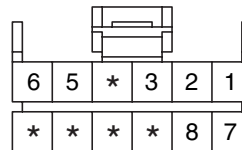

AMP_040M1_12F_B

BLANK

POWER OUTSIDE MIRROR FOLDING

POWER OUTSIDE MIRROR FOLDING (2)

SD878-2

D06

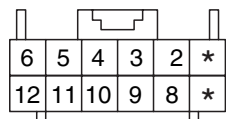

AMP_0407_12F_W_070

D09

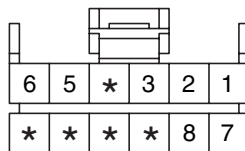

AMP_040M1_12F_B

D29

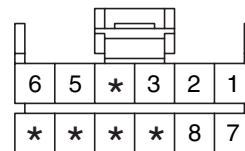



AMP_040M1_12F_B

BLANK

GLASS & MIRROR DEFOGGER

GLASS & MIRROR DEFOGGER (2)

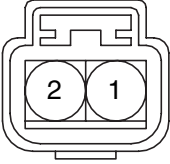
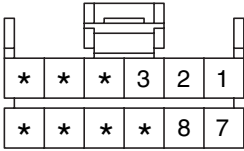
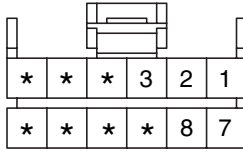
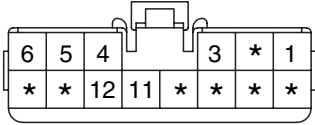
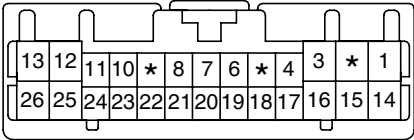
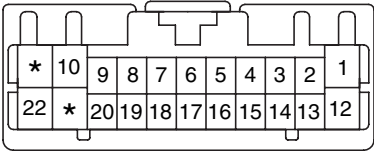
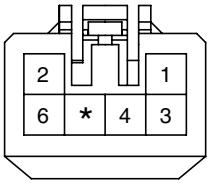
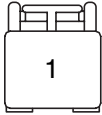
SD879-2

<p style="text-align: center;">C248</p>  <p style="text-align: right; font-size: small;">KUM_NMWP_02F_B</p>	<p style="text-align: center;">D09</p>  <p style="text-align: right; font-size: small;">AMP_040M1_12F_B</p>	<p style="text-align: center;">D29</p>  <p style="text-align: right; font-size: small;">AMP_040M1_12F_B</p>	<p style="text-align: center;">M13-A</p>  <p style="text-align: right; font-size: small;">KET_090II_14F_W</p>
<p style="text-align: center;">M13-B</p>  <p style="text-align: right; font-size: small;">KET_0407_26F_W</p>	<p style="text-align: center;">M13-D</p>  <p style="text-align: right; font-size: small;">KET_0407_22F_W</p>	<p style="text-align: center;">M51</p>  <p style="text-align: right; font-size: small;">AMP_090III_06F_SW_Y</p>	<p style="text-align: center;">R04</p>  <p style="text-align: right; font-size: small;">AMP_PLM2_01F</p>
<p style="text-align: center;">R05</p>  <p style="text-align: right; font-size: small;">AMP_PLM2_01F</p>	<p style="text-align: center;">BLANK</p>	<p style="text-align: center;">BLANK</p>	<p style="text-align: center;">BLANK</p>

DRIVER POWER SEAT (1)

SD880-1

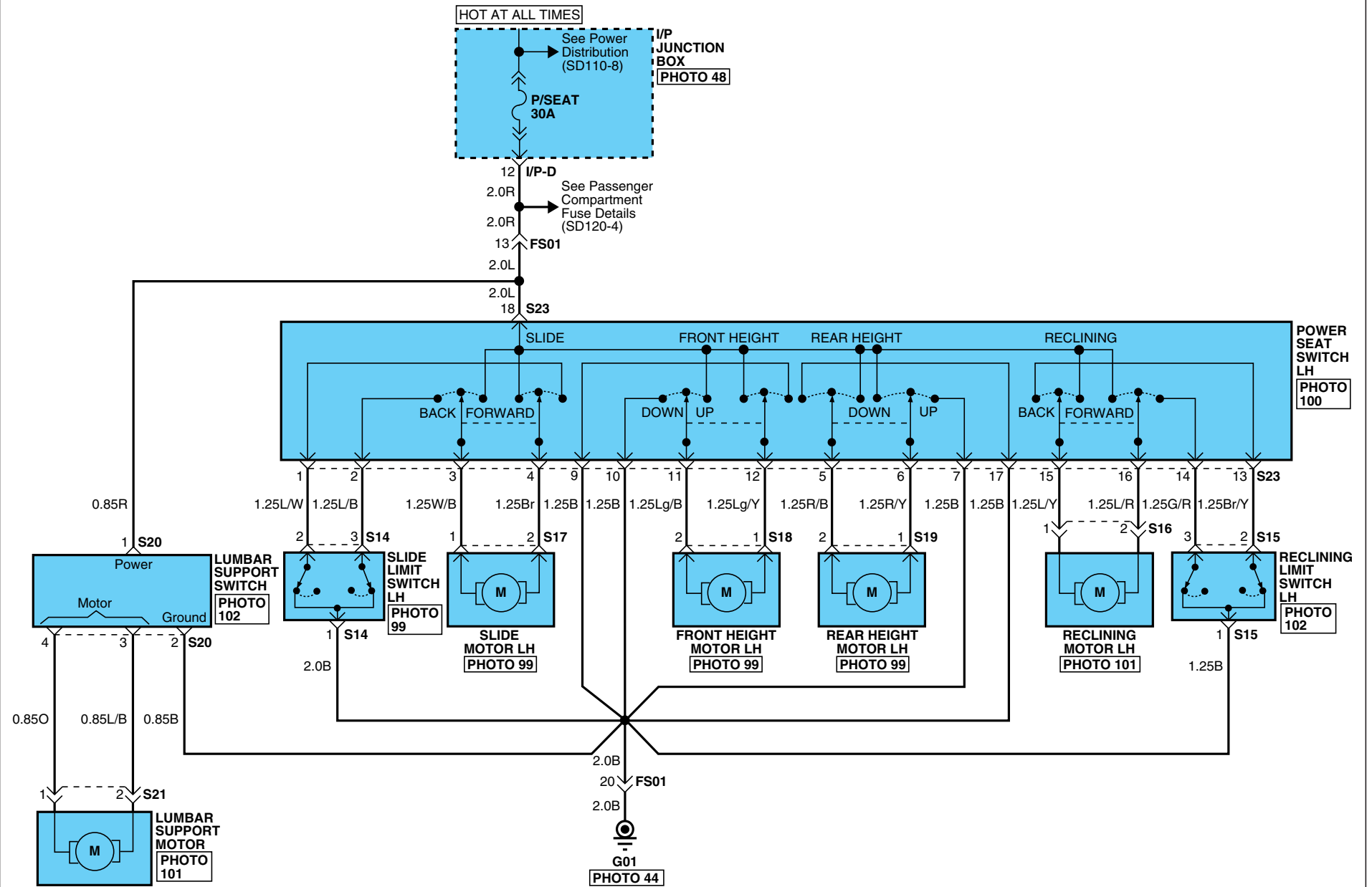

DRIVER POWER SEAT

DRIVER POWER SEAT (2)

SD880-2

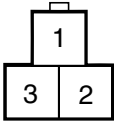
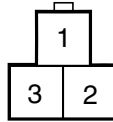
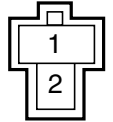
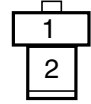
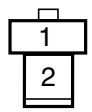
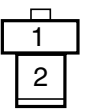
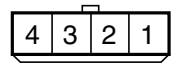
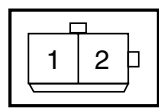
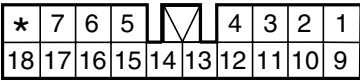
<p style="text-align: center;">S14</p>  <p style="text-align: right; font-size: small;">KET630677</p>	<p style="text-align: center;">S15</p>  <p style="text-align: right; font-size: small;">KET630677</p>	<p style="text-align: center;">S16</p>  <p style="text-align: right; font-size: small;">KET620262</p>	<p style="text-align: center;">S17</p>  <p style="text-align: right; font-size: small;">KET610263</p>
<p style="text-align: center;">S18</p>  <p style="text-align: right; font-size: small;">KET610263</p>	<p style="text-align: center;">S19</p>  <p style="text-align: right; font-size: small;">KET610263</p>	<p style="text-align: center;">S20</p>  <p style="text-align: right; font-size: small;">KET651038</p>	<p style="text-align: center;">S21</p>  <p style="text-align: right; font-size: small;">KET642383</p>
<p style="text-align: center;">S23</p>  <p style="text-align: right; font-size: small;">KET610404</p>	<p style="text-align: center; font-size: large;">BLANK</p>	<p style="text-align: center; font-size: large;">BLANK</p>	<p style="text-align: center; font-size: large;">BLANK</p>

PASSENGER POWER SEAT (1)

SD881-1

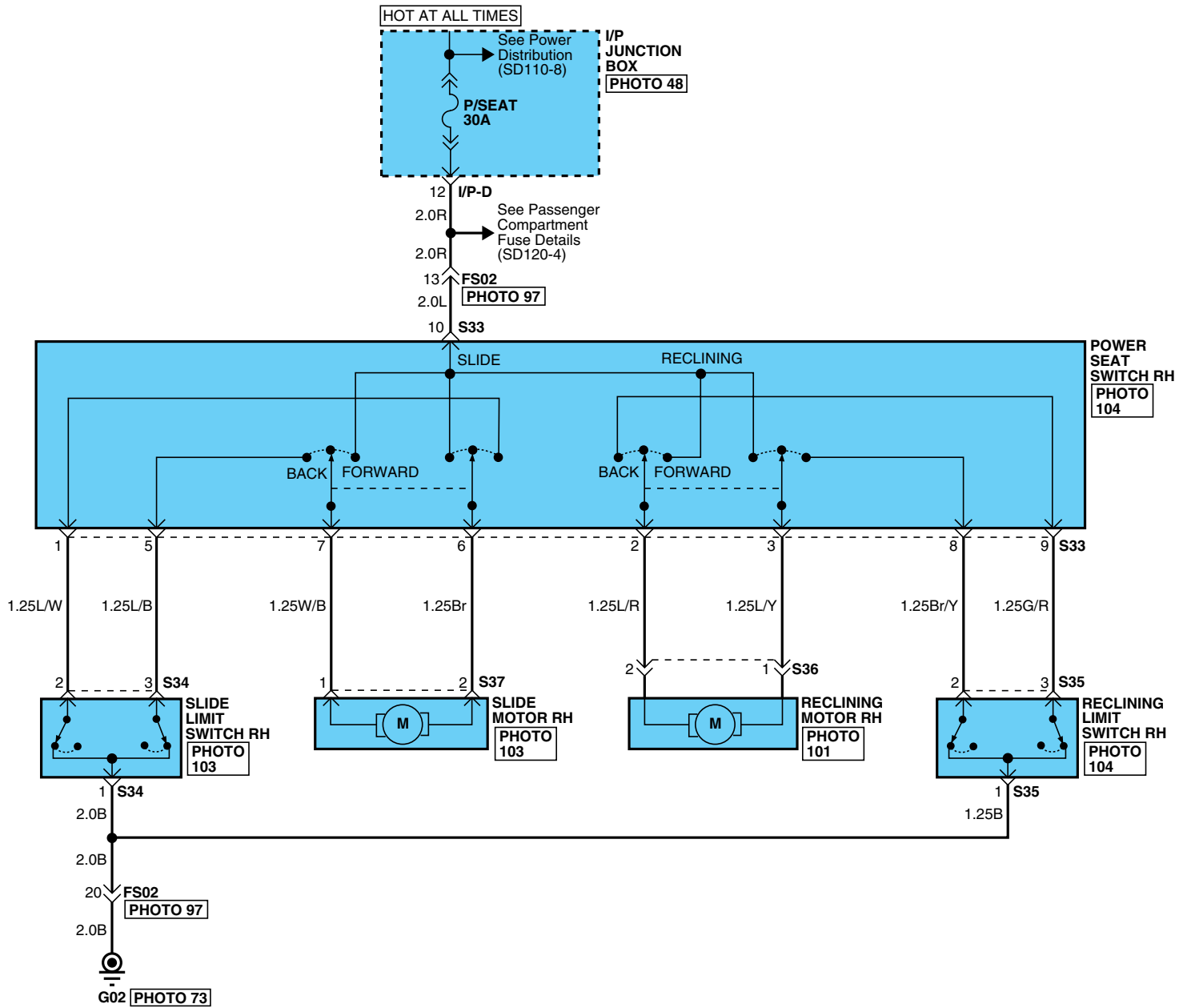

PASSENGER POWER SEAT

PASSENGER POWER SEAT (2)

SD881-2

S33

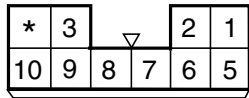

AMP936092-1

S34

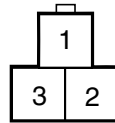

KET630677

S35

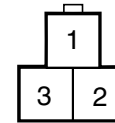

KET630677

S36

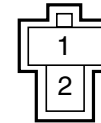

KET620262

S37

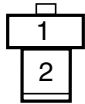

KET610263

BLANK

BLANK

BLANK

MULTI CONTROL SEAT WARMER (1)

SD885-1

LHD ONLY

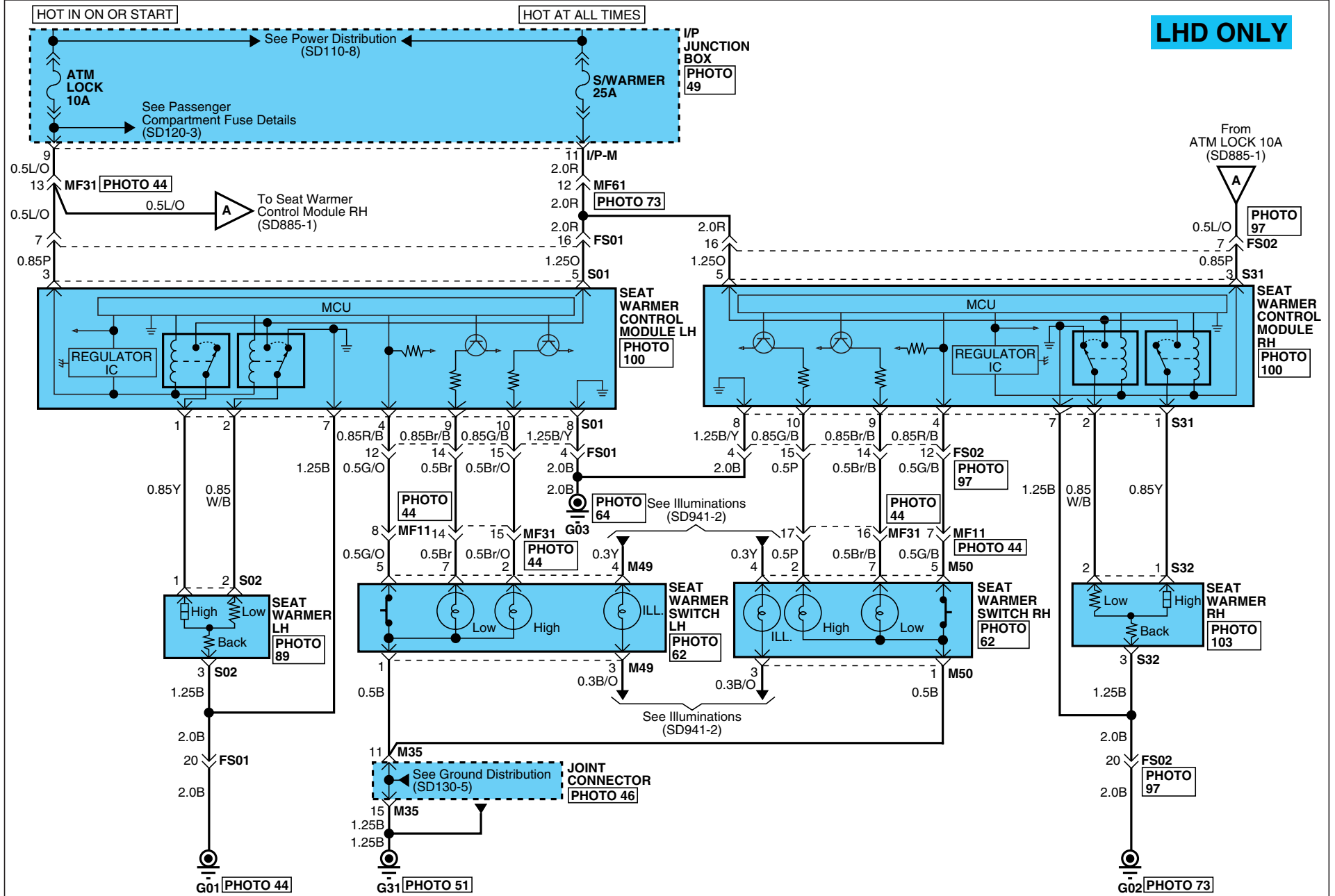

MULTI CONTROL SEAT WARMER

MULTI CONTROL SEAT WARMER (2)

SD885-2

RHD ONLY

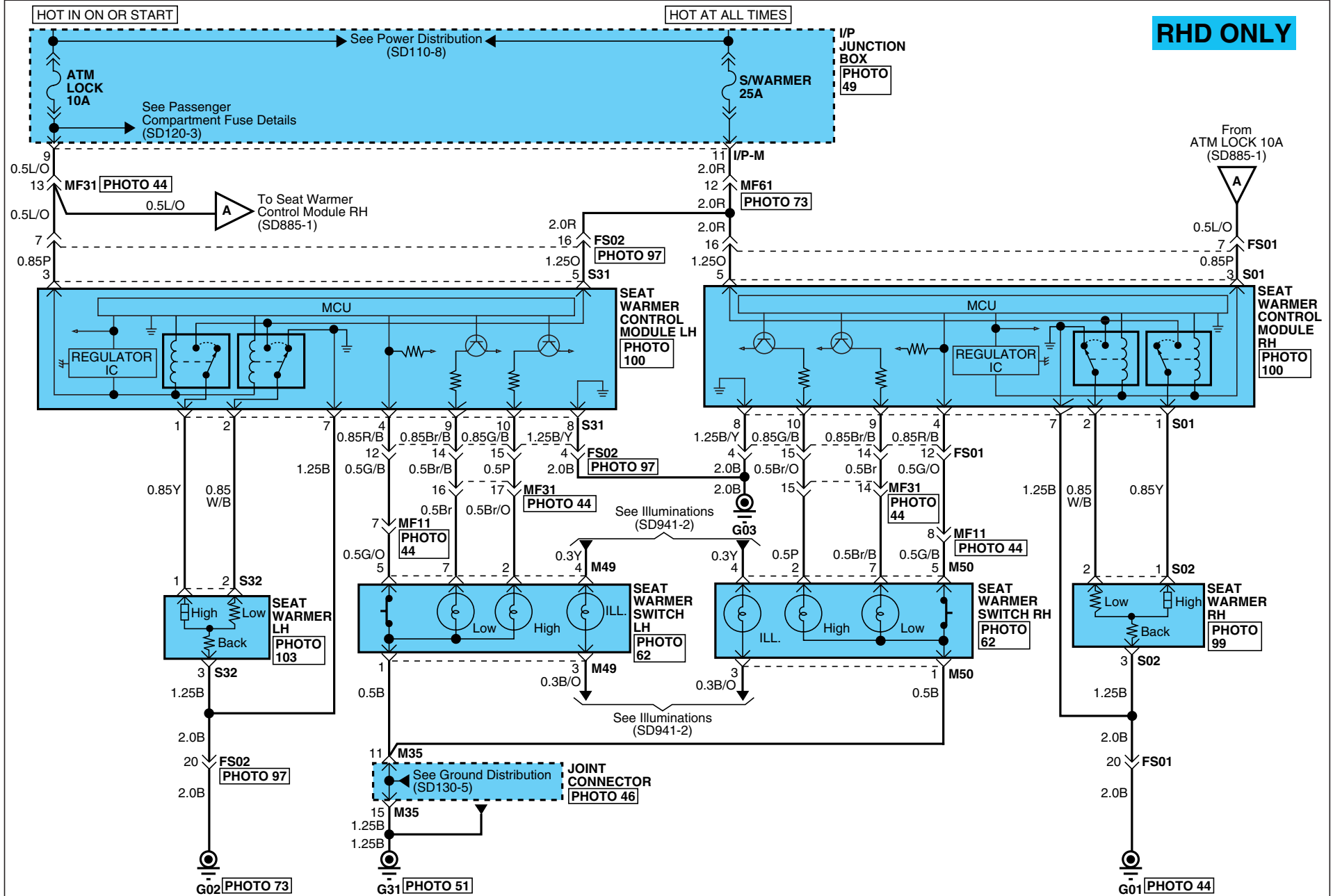

MULTI CONTROL SEAT WARMER

MULTI CONTROL SEAT WARMER (3)

SD885-3

M49

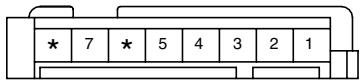

AMP_MQS_08F_W

M50

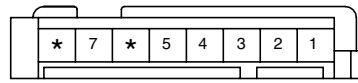

AMP_MQS_08F_B

S01

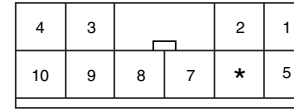

KET_MG651056

S02

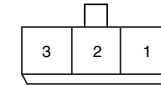

KET_MG651032

S31

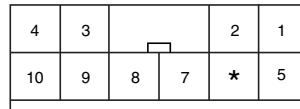

KET_MG651056

S32

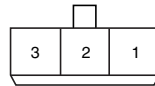

KET_MG651032

BLANK

BLANK

MULTI CONTROL SEAT WARMER

MULTI CONTROL SEAT WARMER (4)

SD885-4

MEMO

HEAD LAMPS (1)

SD921-1

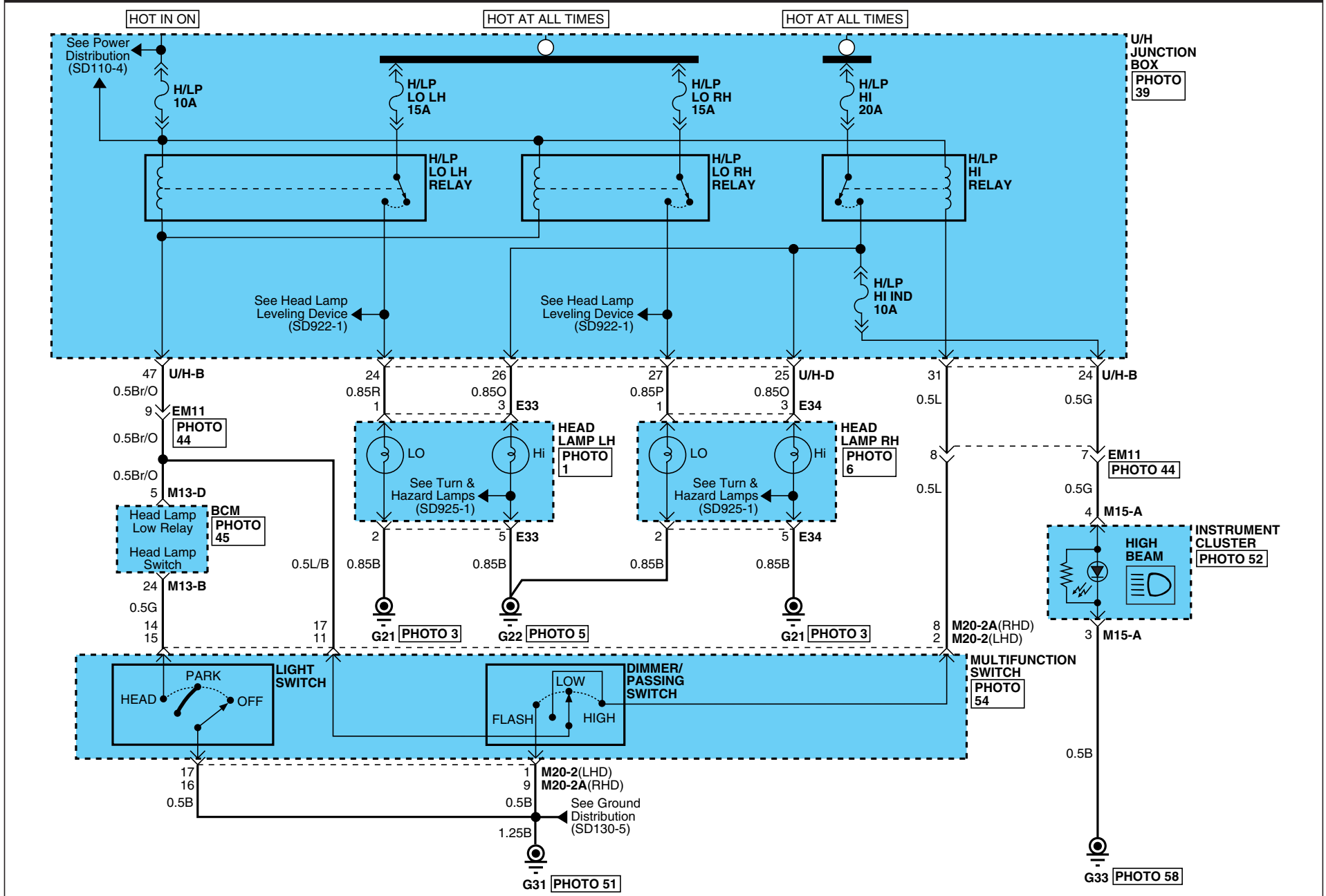

HEAD LAMPS

HEAD LAMPS (2)

SD921-2

B13-D

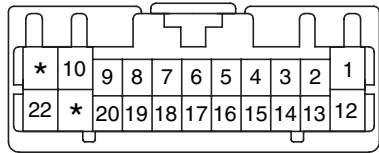

KET_0407_22F_W

E33



KUM_NMWP_06F_B

E34

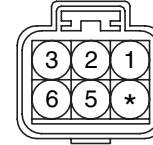

KUM_NMWP_06F_B

M13-B

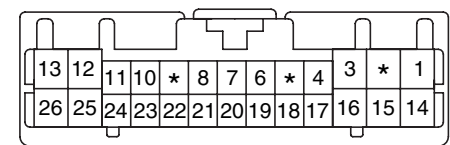

KET_0407_26F_W

M15-A

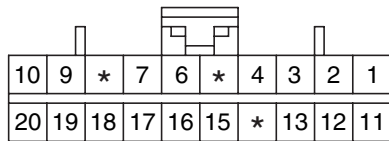

AMP_040M2_20F_B

M20-2

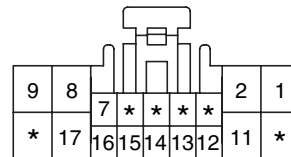

KET_0509_18F_W

M20-2A

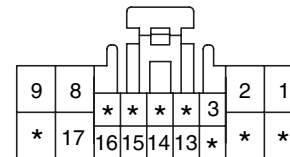

KET_0509_18F_W

BLANK

HEAD LAMP LEVELING DEVICE (1)

SD922-1

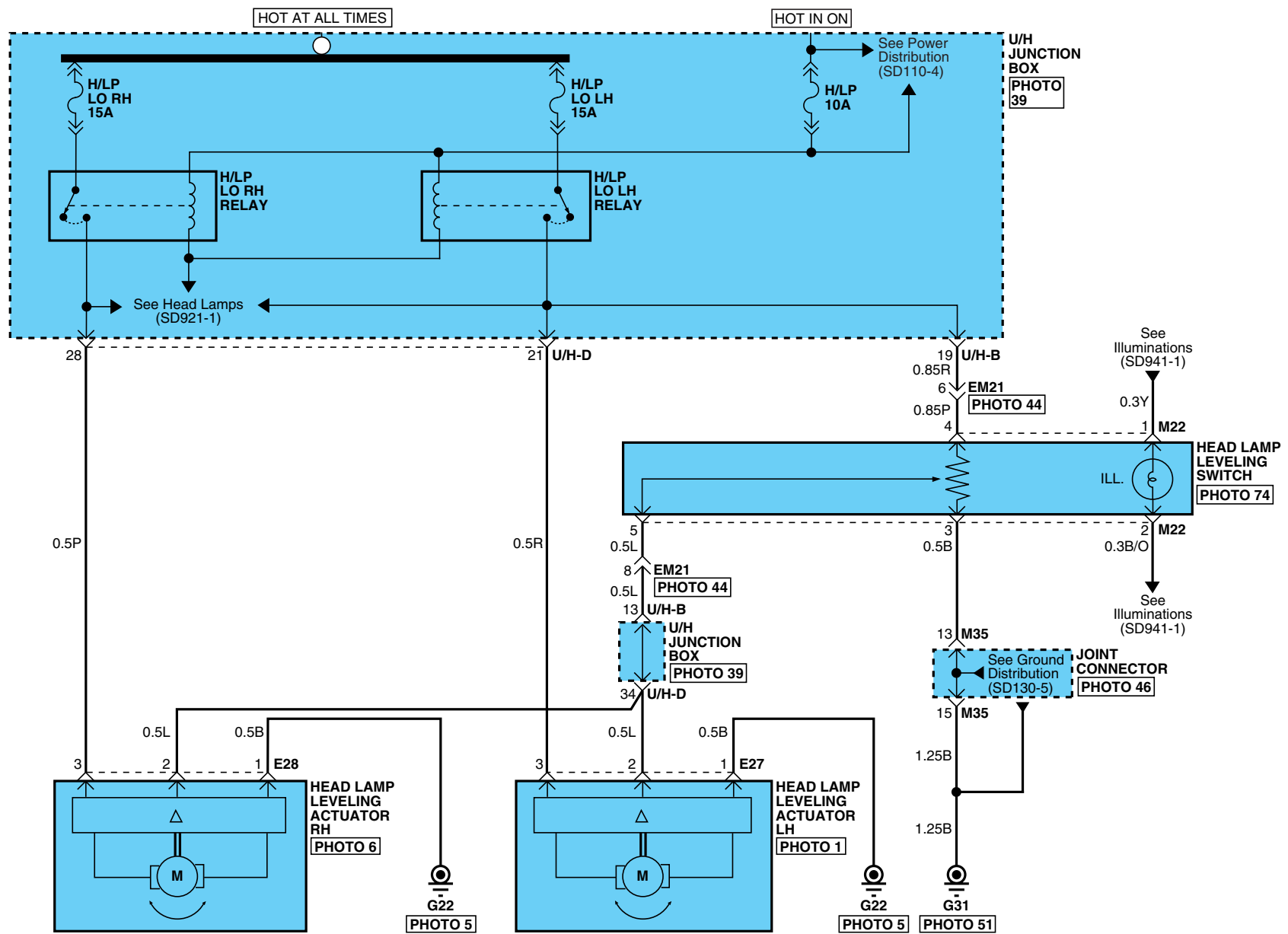

HEAD LAMP LEVELING DEVICE

HEAD LAMP LEVELING DEVICE (2)

SD922-2

E27

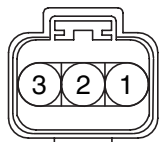

AMP_025WP_03F_B

E28

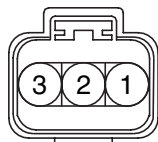

AMP_025WP_03F_B

M22

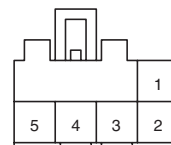

KUM_CDR_05F_W

BLANK

HEAD LAMP WASHER

EAF5BAB5

HEAD LAMP WASHER (1)

SD923-1

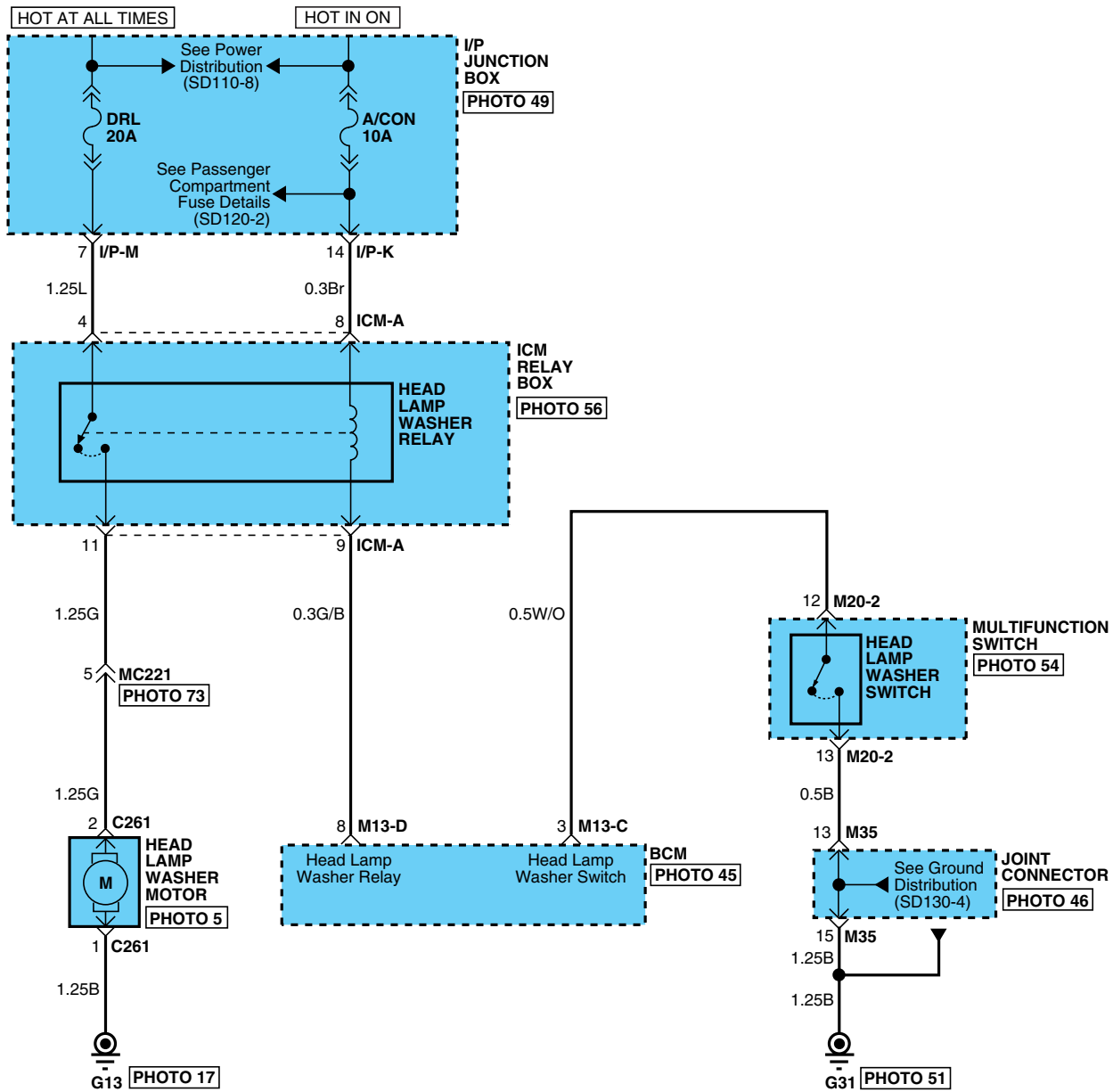

HEAD LAMP WASHER

HEAD LAMP WASHER (2)

SD923-2

C261

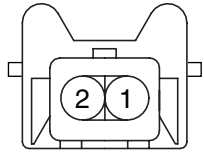

AMP_JPT_02F_B_CLIP

ICM-A

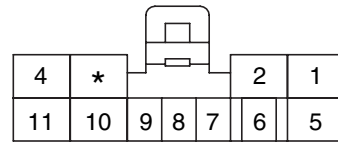

KET_1809_11F_W_UNIT

M13-C

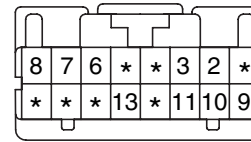

KET_0407_16F_W

M13-D

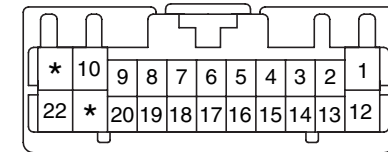

KET_0407_22F_W

M20-2

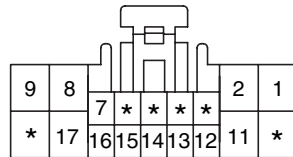

KET_0509_18F_W

BLANK

BLANK

BLANK

FOG LAMPS

FOG LAMPS (2)

SD924-2

E24



KET_110WP_02F_B_FOG

E25



KET_110WP_02F_B_FOG

F45

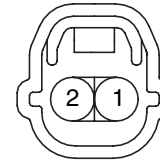

KET_SSD_02F_B

ICM-A

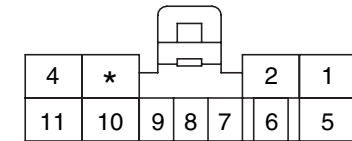

KET_1809_11F_W_UNIT

M13-B

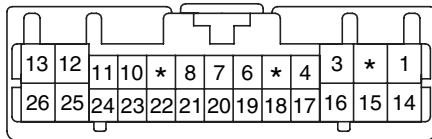

KET_0407_26F_W

M13-C

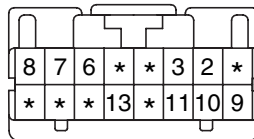

KET_0407_16F_W

M13-D

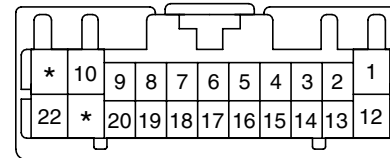

KET_0407_22F_W

M20-2

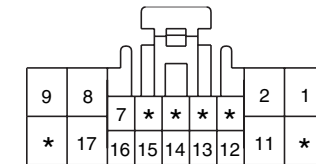

KET_0509_18F_W

M20-2A

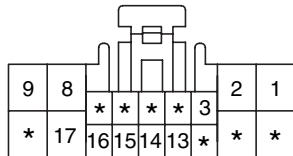

KET_0509_18F_W

M29

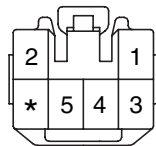

KET_090II_06F_L

M55

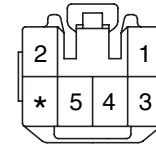

KET_090II_06F_Gr

M68

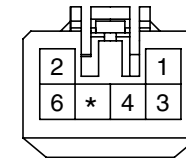

AMP_090III_06F_SW_W

M69

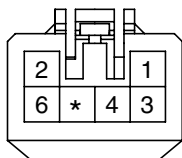

AMP_090III_06F_L

BLANK

BLANK

BLANK

TURN & HAZARD LAMPS (1)

SD925-1

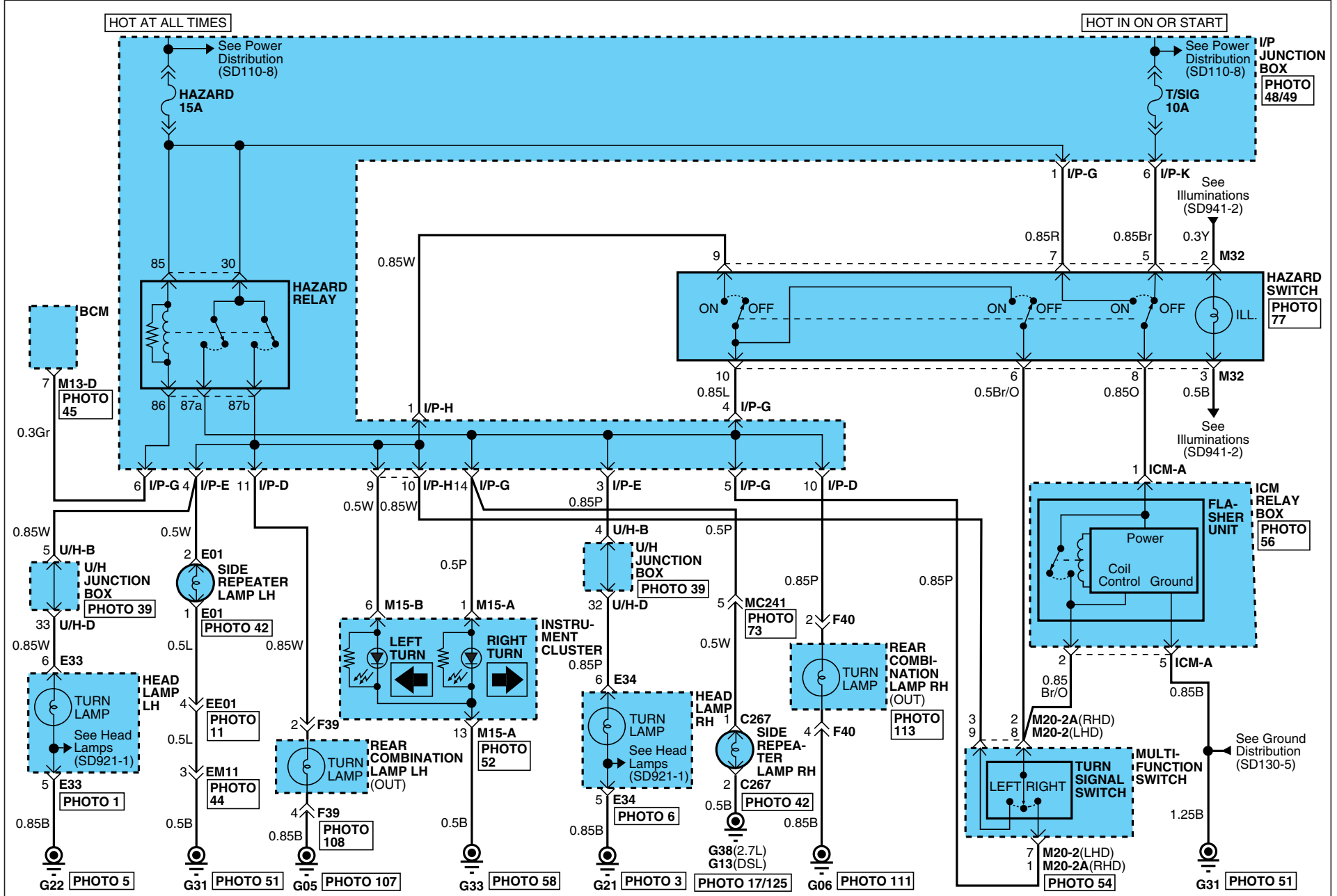

TURN & HAZARD LAMPS

TURN & HAZARD LAMPS (2)

SD925-2

C267

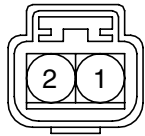

KUM_NMWP_02F_B

E01

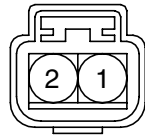

KUM_NMWP_02F_B

E33

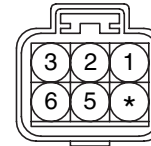

KUM_NMWP_06F_B

E34

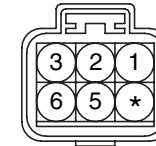

KUM_NMWP_06F_B

F39

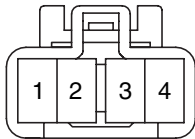

KET_090II_04M_W

F40

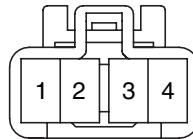

KET_090II_04M_W

ICM-A

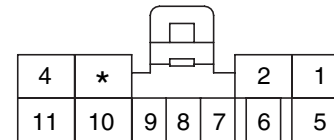

KET_1809_11F_W_UNIT

M13-D

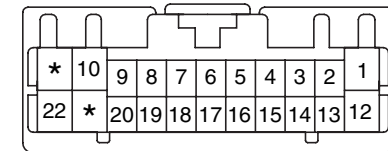

KET_0407_22F_W

M15-A

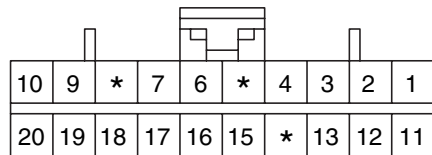

AMP_040M2_20F_B

M15-B

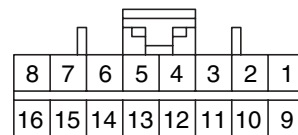

AMP_040M2_16F_B

M20-2

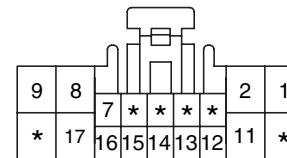

KET_0509_18F_W

M20-2A

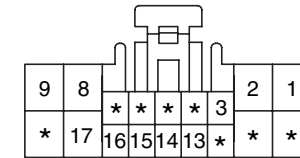

KET_0509_18F_W

M32

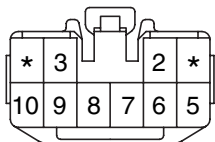

KET_090II_10F_W

BLANK

BLANK

BLANK

BACK-UP LAMPS (1)

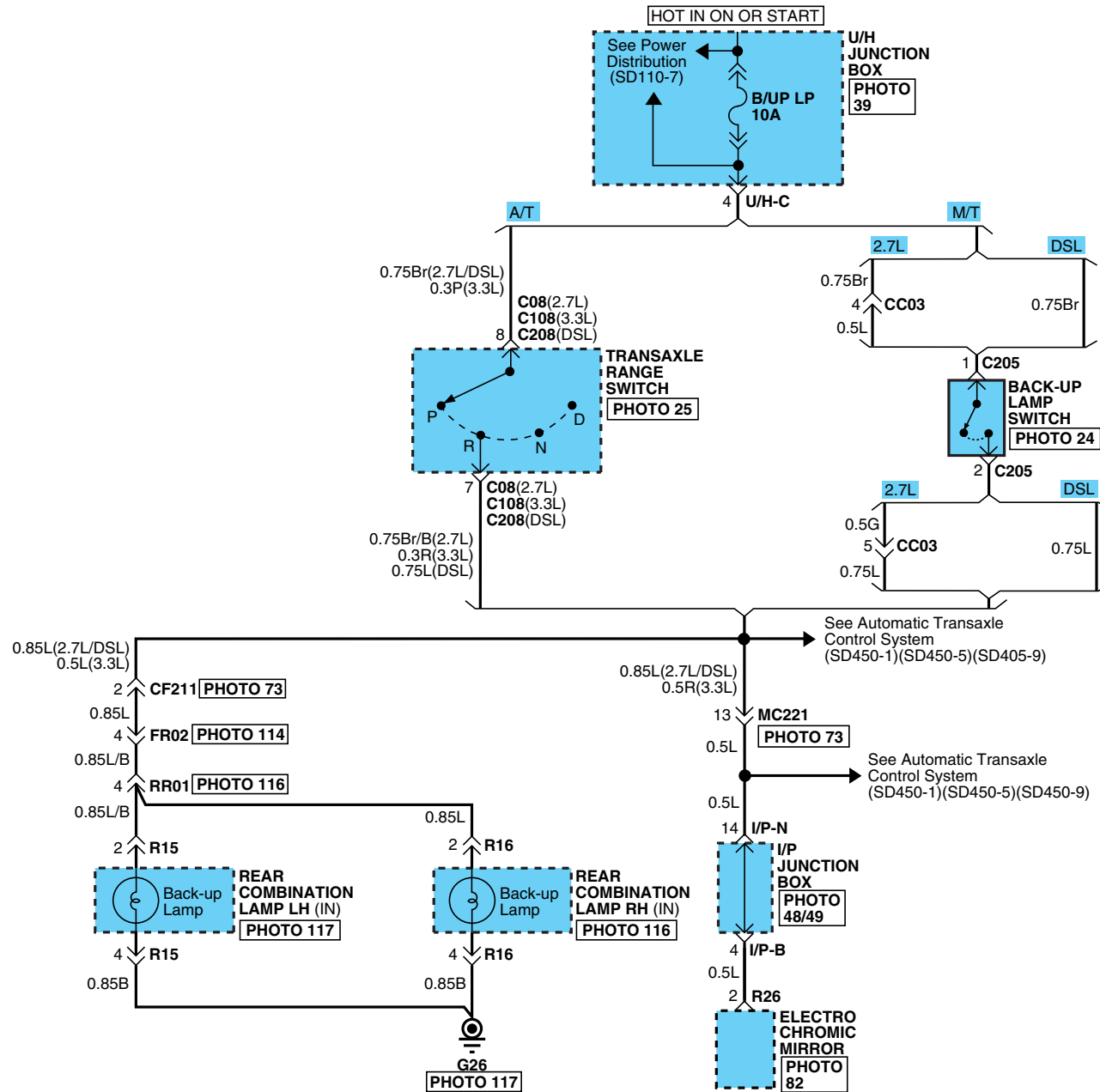

BACK-UP LAMPS

BACK-UP LAMPS (2)

SD926-2

C08



KET_SSD_10F_B_A

C108



KET_SSD_10F_B_A

C205

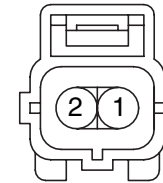

AMP_EJWP_02F_B

C208

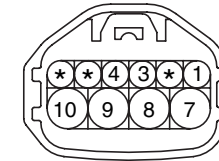

KET_SSD_10F_B_A

R15

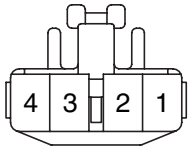

KET_090II_04F_W

R16

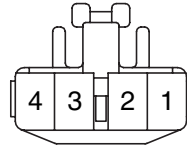

KET_090II_04F_W

R26

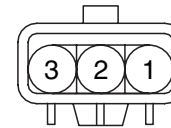

KET_TLCWP_03F_W

BLANK

STOP LAMPS (1)

SD927-1

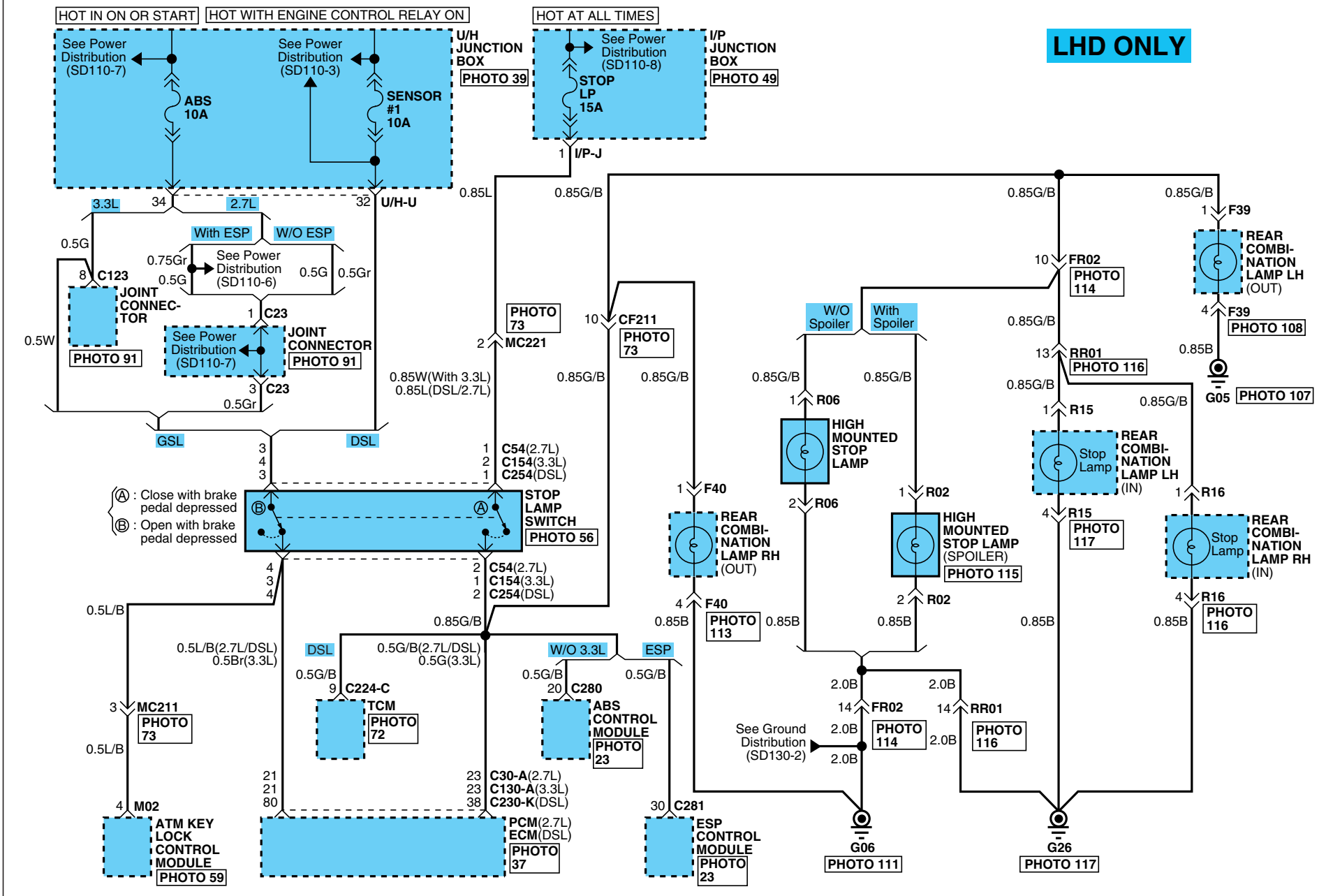

STOP LAMPS

STOP LAMPS (2)

SD927-2

RHD ONLY

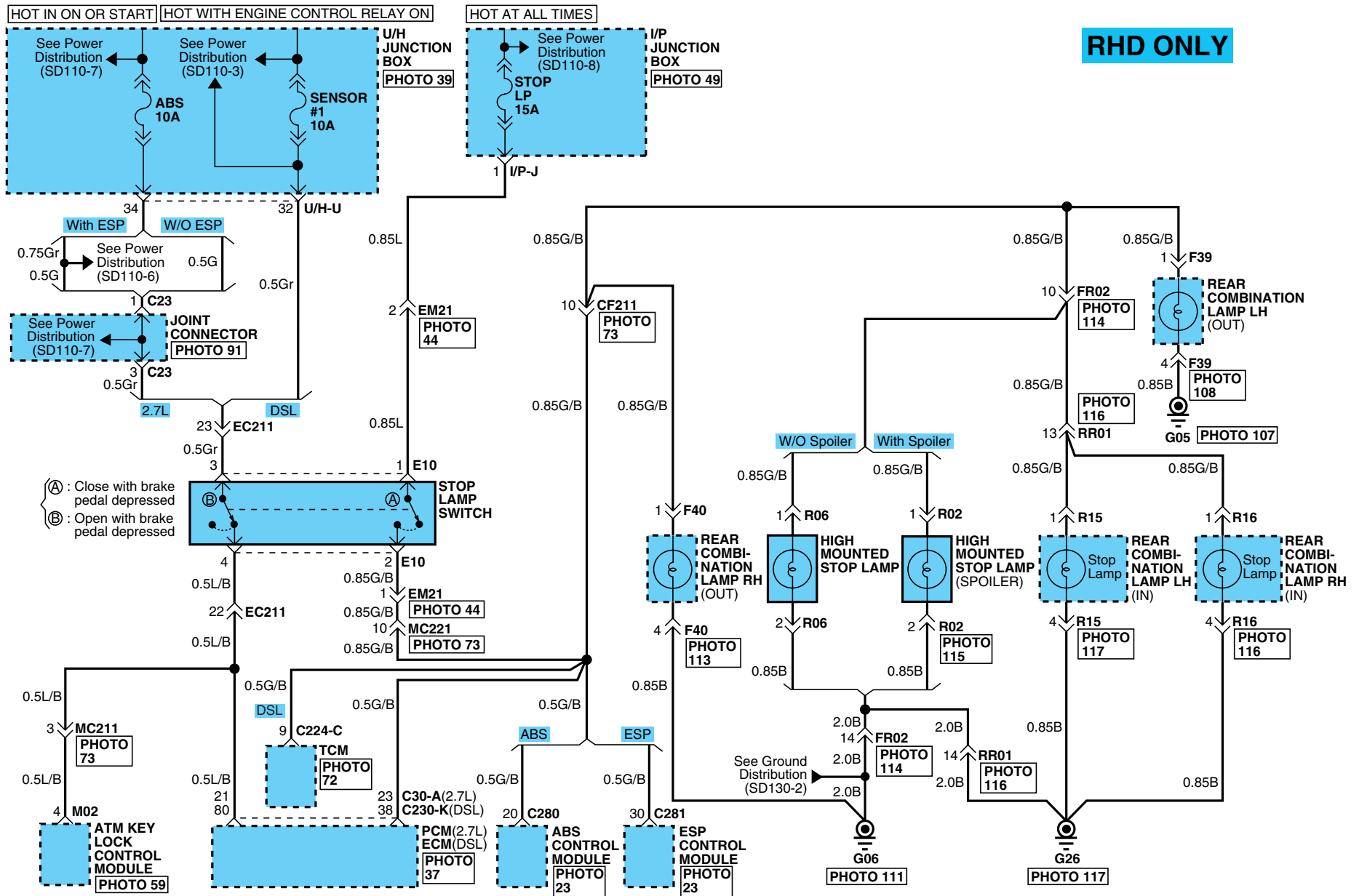

STOP LAMPS

STOP LAMPS (3)

SD927-3

C30-A

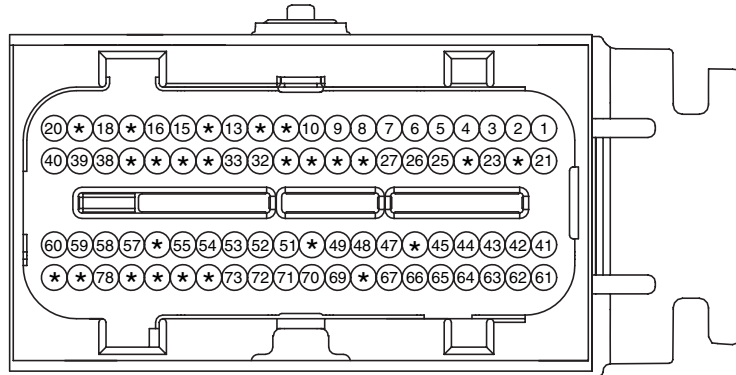

PKD_ECU_80F_Gr_NR

C130-A

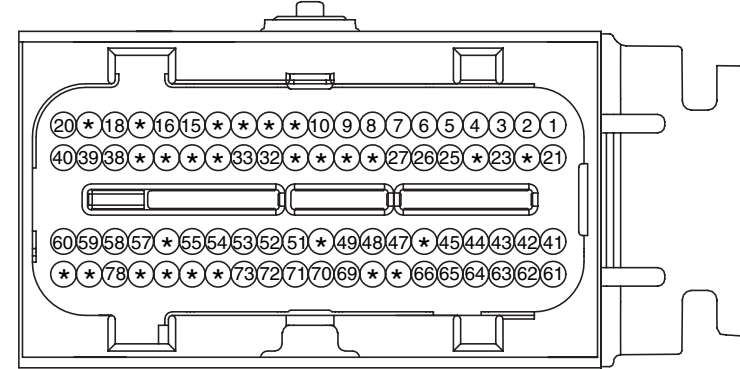

PKD_ECU_80F_Gr_3

C54

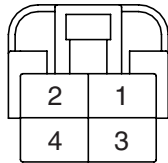

KET_250DL_04F_W

C154

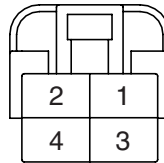

KET_250DL_04F_W

C224-C

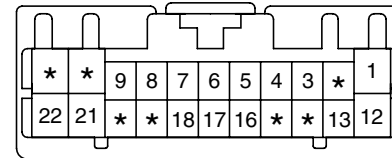

KET_0407_22F_W

C254

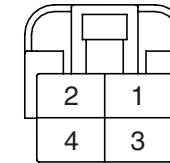

KET_250DL_04F_W

C230-K

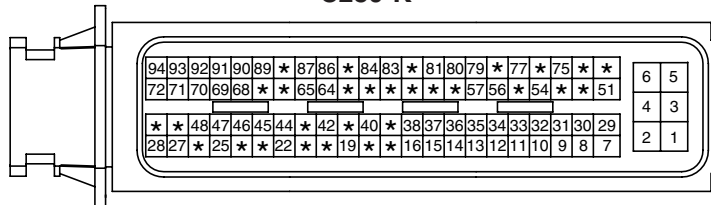

AMP_ECU_94F_B

C280(2.7L)

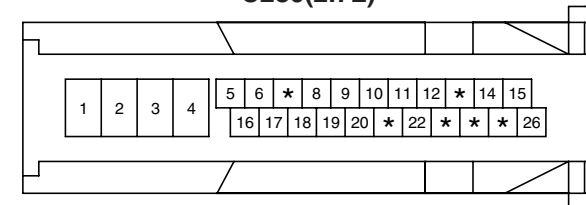

BOS_ABS_26F_B_L

C280(DSL)

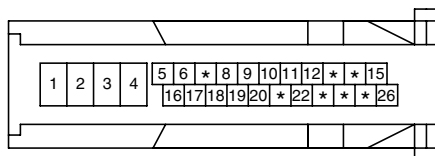

BOS_ABS_26F_B_L

C281(GSL)

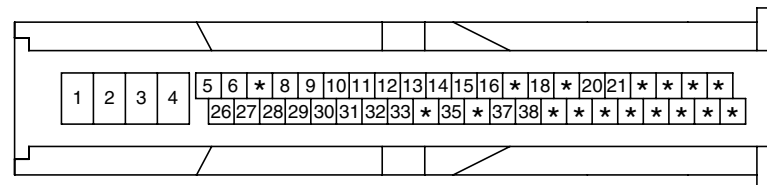

BOS_ESP_46F_B_L

BLANK

STOP LAMPS

STOP LAMPS (4)

SD927-4

C281(DSL)

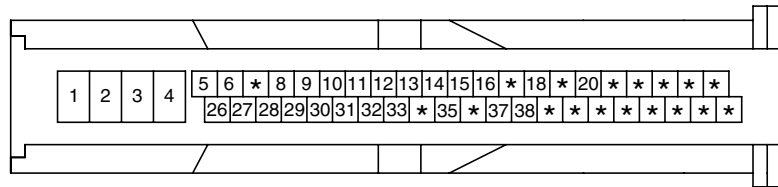

BOS_ESP_46F_B_L

E10

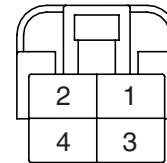

KET_250DL_04F_W

F39

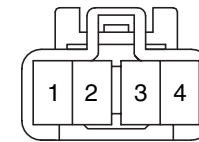

KET_090II_04M_W

F40

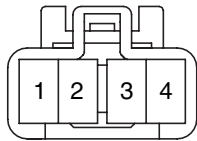

KET_090II_04M_W

M02

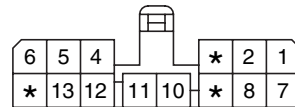

AMP_070_14F_W

R02

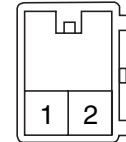

KUM_CDR_02M

R06

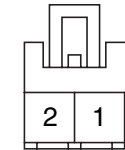

KUM_CDR_02F_W

R15

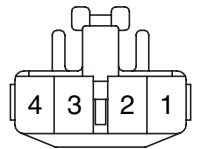

KET_090II_04F_W

R16

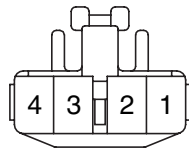

KET_090II_04F_W

BLANK

BLANK

TAIL, PARKING & LICENSE LAMPS (1)

SD928-1

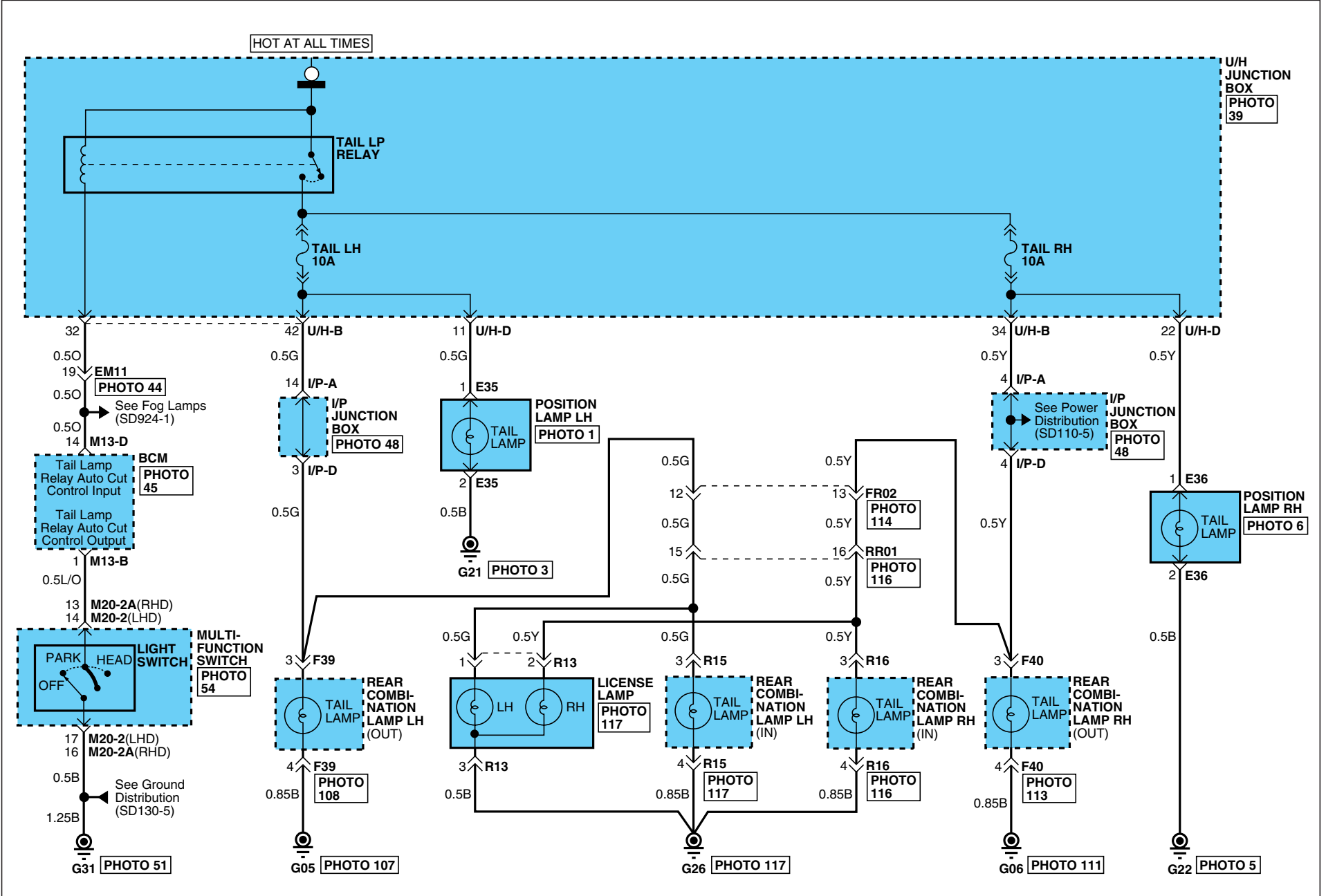

TAIL, PARKING & LICENSE LAMPS

TAIL, PARKING & LICENSE LAMPS (2)

SD928-2

E35

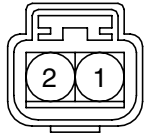

KUM_NMWP_02F_B

E36

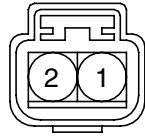

KUM_NMWP_02F_B

F39

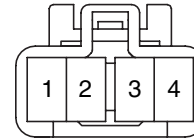

KET_090II_04M_W

F40

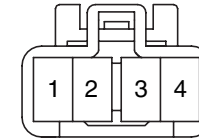

KET_090II_04M_W

M13-B

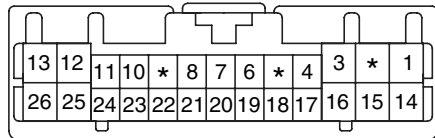

KET_0407_26F_W

M13-D

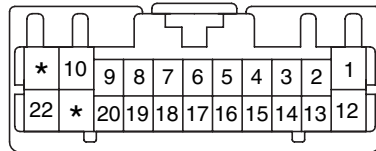

KET_0407_22F_W

M20-2

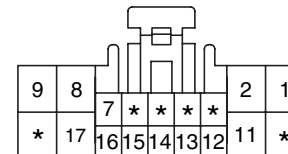

KET_0509_18F_W

M20-2A

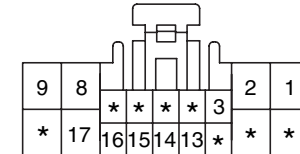

KET_0509_18F_W

R13

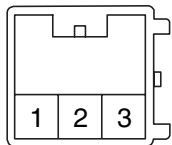

KUM_CDR_03M_W

R15

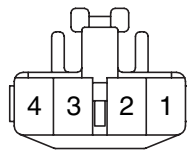

KET_090II_04F_W

R16

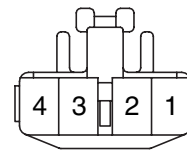

KET_090II_04F_W

BLANK

COURTESY & TAIL GATE LAMPS (1)

SD929-1

W/O Trip Computer

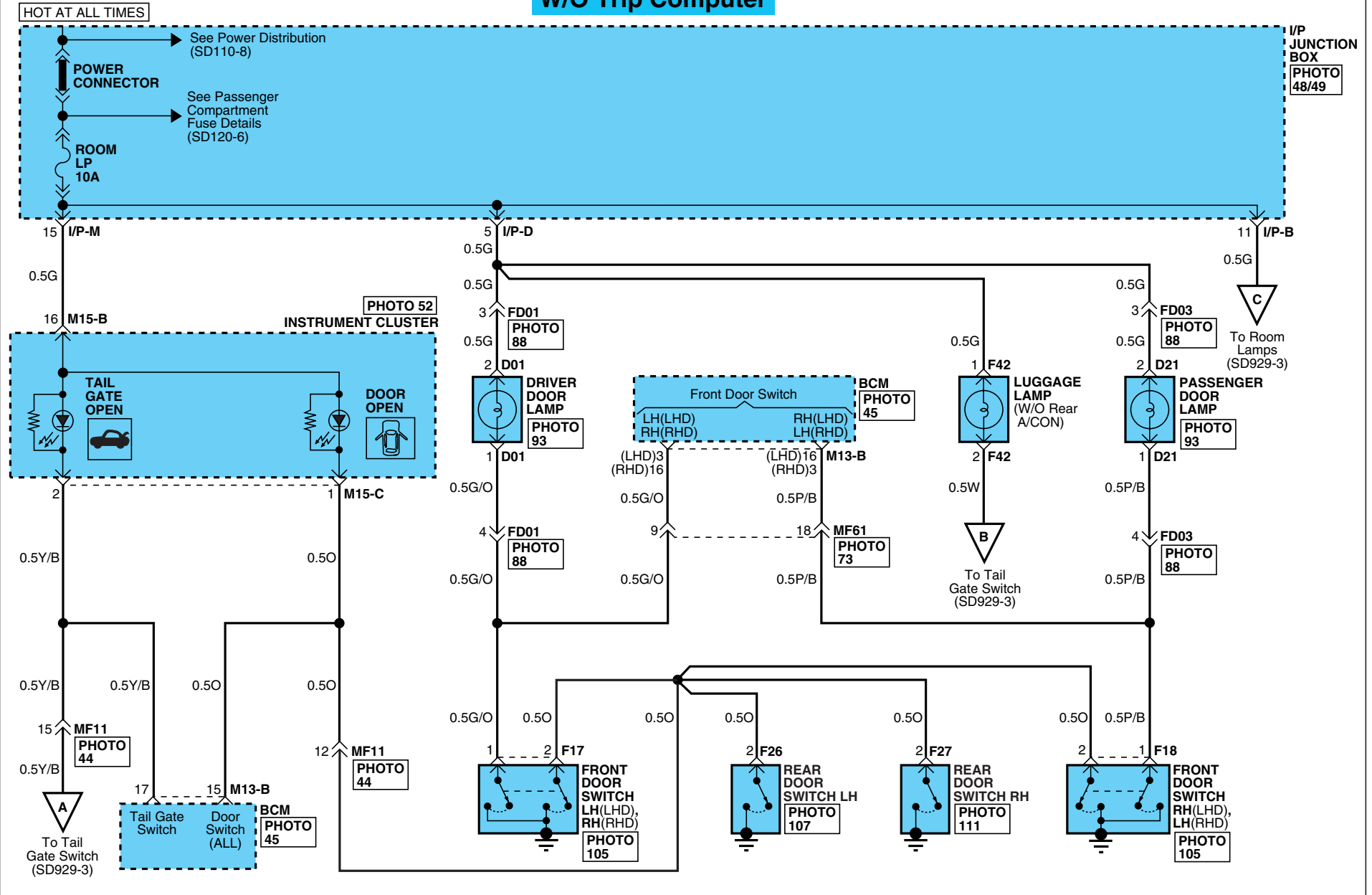

COURTESY & TAIL GATE LAMPS

COURTESY & TAIL GATE LAMPS (3)

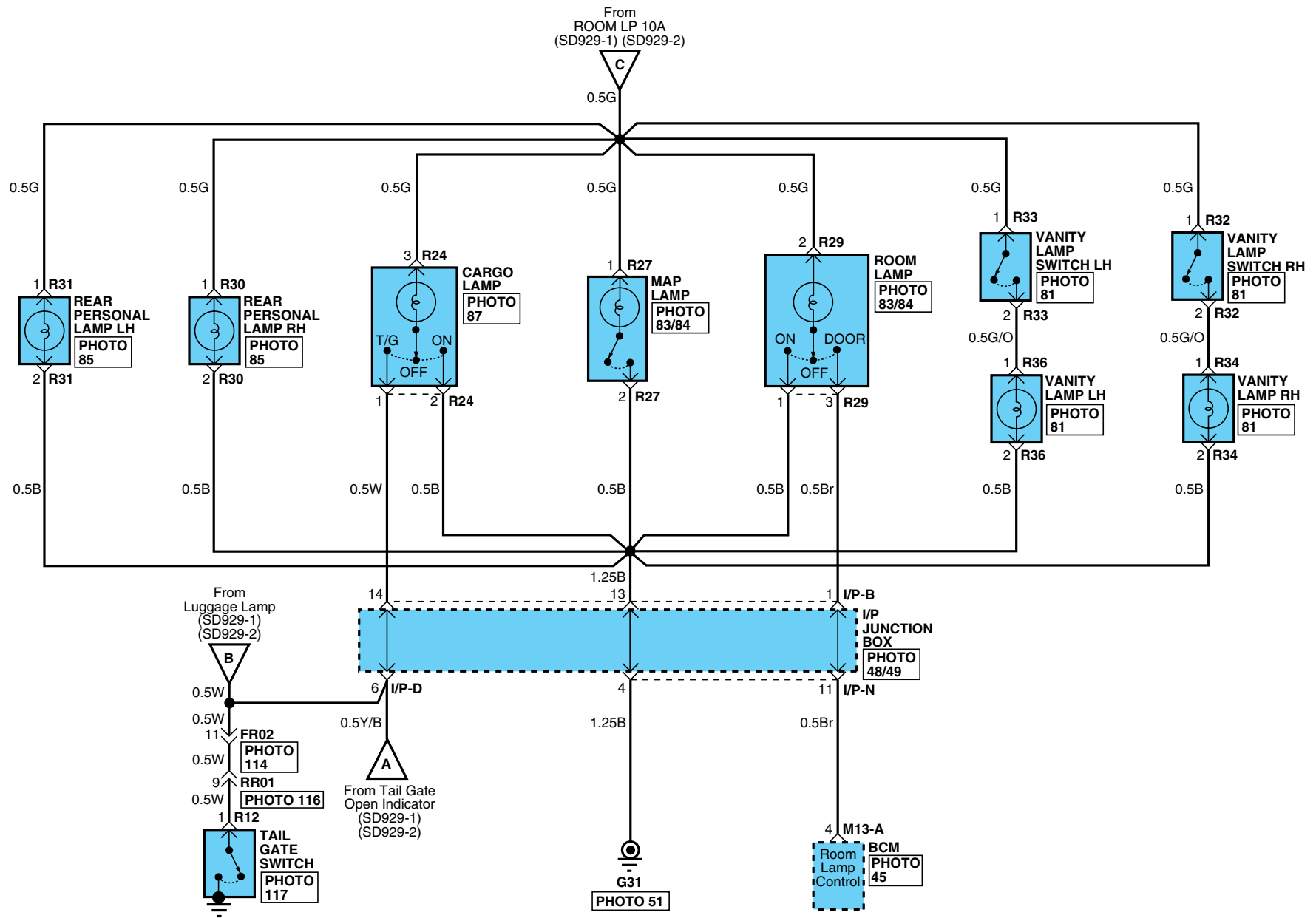

SD929-3



COURTESY & TAIL GATE LAMPS

COURTESY & TAIL GATE LAMPS (4)

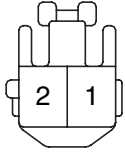
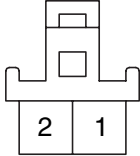
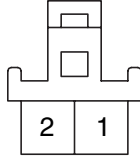
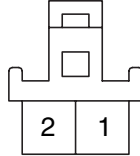
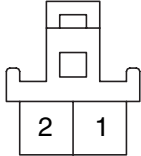
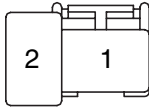
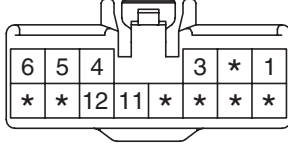
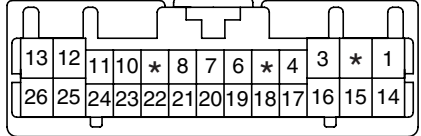
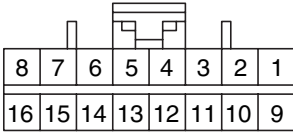
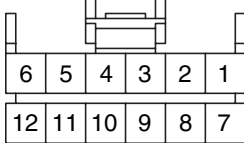
SD929-4

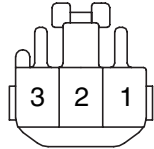
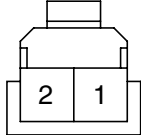
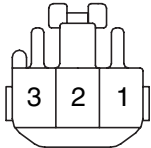
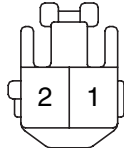
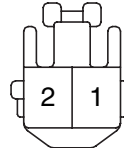
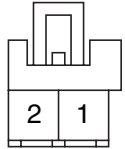
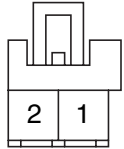
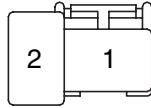
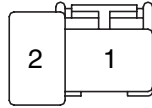
<p>D01/D21</p>  <p>KET_090II_02F_W_L</p>	<p>F17</p>  <p>KET_070_02F_W</p>	<p>F18</p>  <p>KET_070_02F_W</p>	<p>F26</p>  <p>KET_070_02F_W</p>
<p>F27</p>  <p>KET_070_02F_W</p>	<p>F42</p>  <p>AMP_PLM2_02F_W</p>	<p>M13-A</p>  <p>KET_090II_14F_W</p>	<p>M13-B</p>  <p>KET_0407_26F_W</p>
<p>M15-B</p>  <p>AMP_040M2_16F_B</p>	<p>M15-C</p>  <p>AMP_040M1_12F_B</p>	<p>R12</p>  <p>AMP_250DL_01F_B</p>	<p>R24</p>  <p>KET_09011_03F_W</p>
<p>R27</p>  <p>AMP_070_02F_W</p>	<p>R29</p>  <p>KET_090II_03F_W</p>	<p>R30</p>  <p>KET_090II_02F_W_L</p>	<p>R31</p>  <p>KET_090II_02F_W_L</p>
<p>R32</p>  <p>KUM_CDR_02F_W</p>	<p>R33</p>  <p>KUM_CDR_02F_W</p>	<p>R34</p>  <p>AMP_PLM2_02F_B</p>	<p>R36</p>  <p>AMP_PLM2_02F_B</p>

INDICATORS & GAUGES (1)

SD940-1

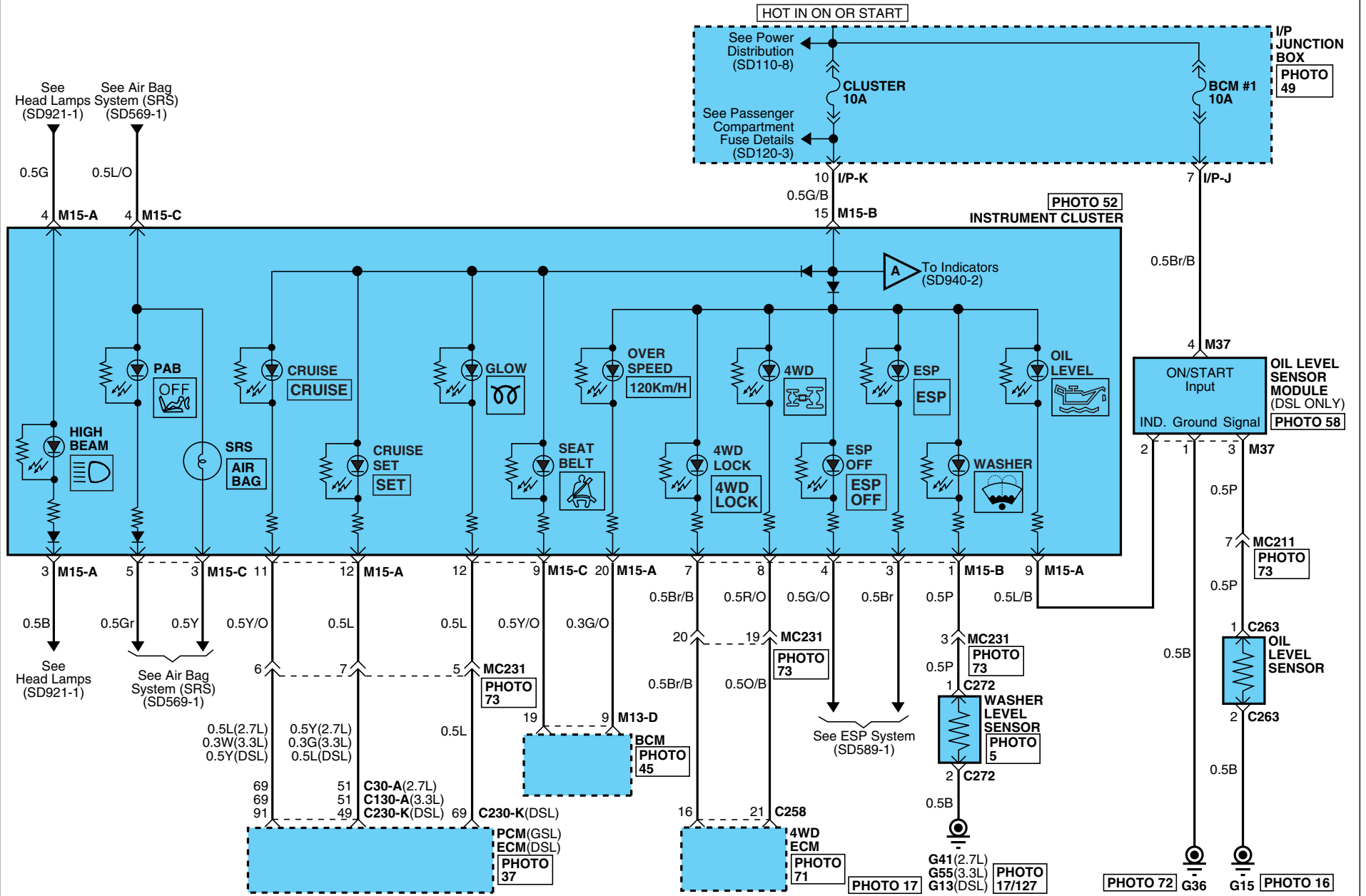

INDICATORS & GAUGES

INDICATORS & GAUGES (4)

SD940-4

With Trip Computer

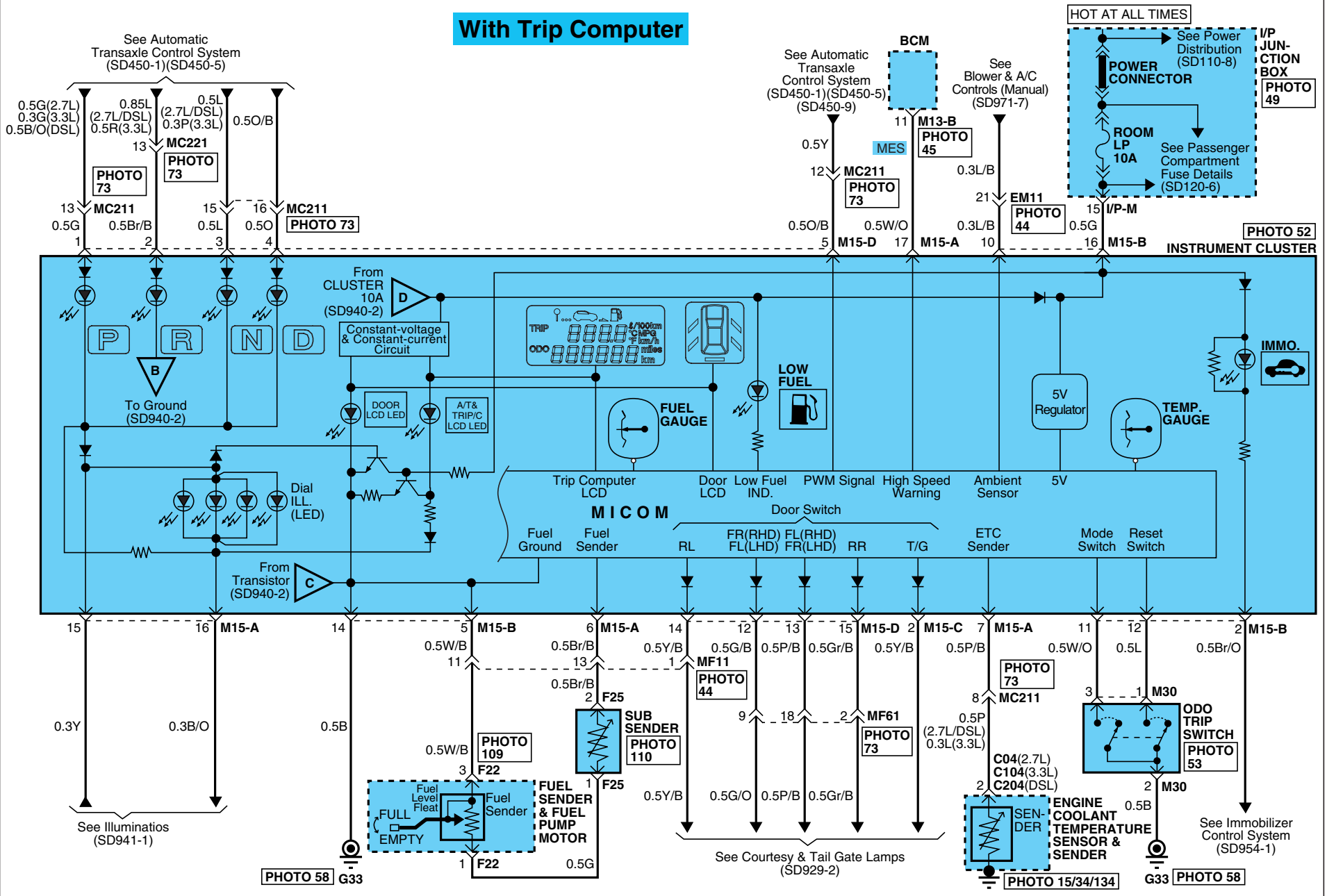

INDICATORS & GAUGES

INDICATORS & GAUGES (5)

SD940-5

C30-A

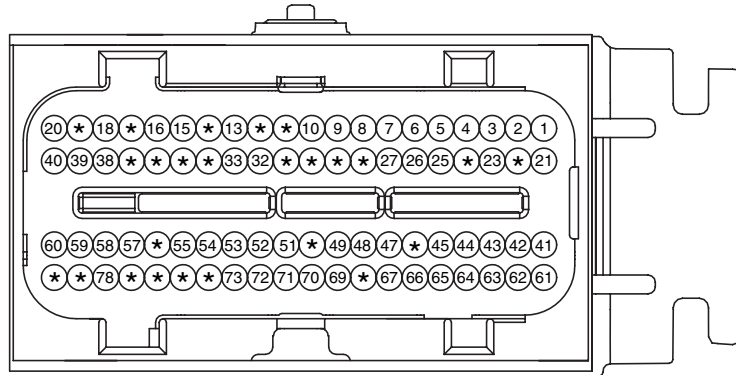

PKD_ECU_80F_Gr_NR

C130-A

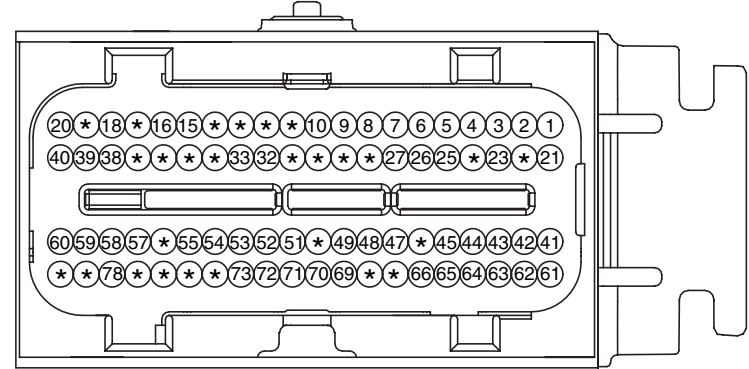

PKD_ECU_80F_Gr_3

C04

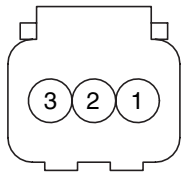

KUM_WTS_03F_B

C104

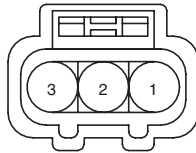

KUM_62Z_03F_B_WTS

C204

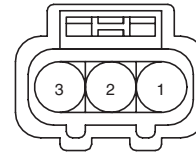

KUM_62Z_03F_B_WTS

C211



KUM_NMWP_01F_B

C216(2.7L/DSL)

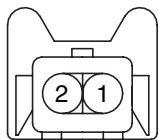

AMP_JPT_02F_B_CLIP

C216(3.3L)

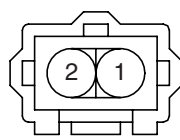

KUM_JFC_02F_B

C230-K

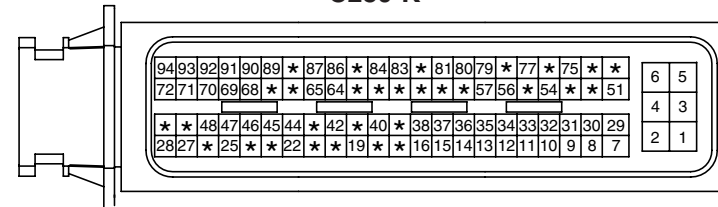

AMP_ECU_94F_B

C258(2.7L/DSL)

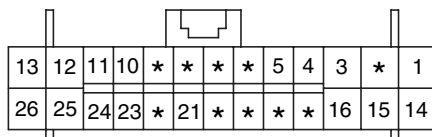

AMP_0407_26F_W_HD

C258(3.3L)

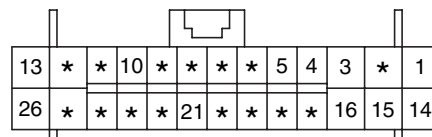

AMP_0407_26F_W_HD

C263





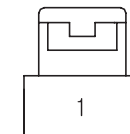

KUM_NMWP_02F_B

C264

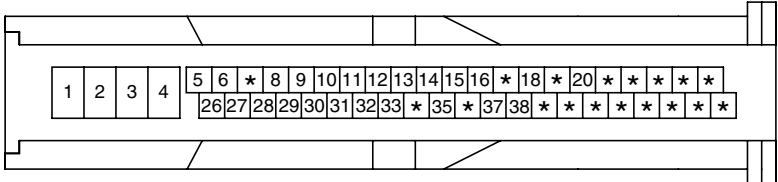
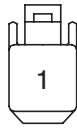
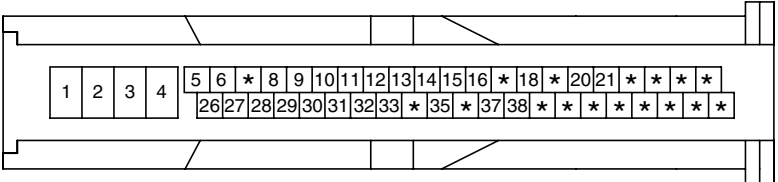

RYO_250_01F_W_SW

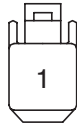
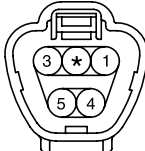
INDICATORS & GAUGES

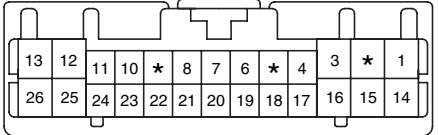
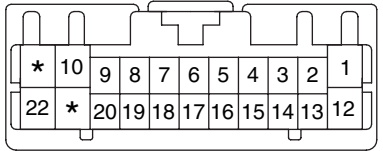
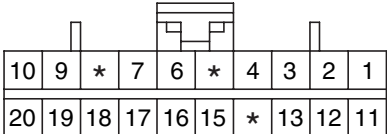
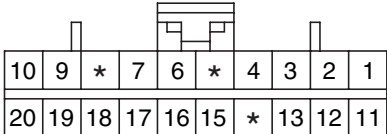
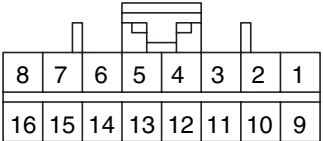
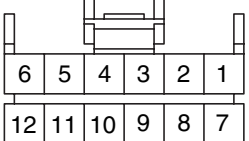
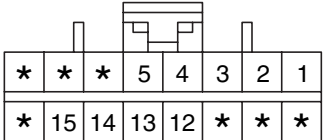
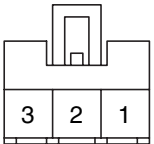
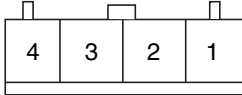
INDICATORS & GAUGES (6)			SD940-6
<p>C272</p>  <p>KUM_NMWP_02F_B</p>	<p>C281(DSL)</p>  <p>BOS_ESP_46F_B_L</p>	<p>E06</p>  <p>KET_090II_01F_W</p>	
<p>C281(GSL)</p>  <p>BOS_ESP_46F_B_L</p>	<p>F10</p>  <p>AMP_PLM2_01F_B</p>	<p>F13</p>  <p>KET_090II_01F_W</p>	
<p>F22</p>  <p>KET_090IWP_05F_Gr_2</p>	<p>F25</p>  <p>KET_090IWP_02F_B_L</p>	<p>M13-B</p>  <p>KET_0407_26F_W</p>	<p>M13-D</p>  <p>KET_0407_22F_W</p>
<p>M15-A</p>  <p>AMP_040M2_20F_B</p>	<p>M15-A</p>  <p>AMP_040M2_20F_B</p>	<p>M15-B</p>  <p>AMP_040M2_16F_B</p>	<p>M15-C</p>  <p>AMP_040M1_12F_B</p>
<p>M15-D</p>  <p>AMP_040M1_16F_B</p>	<p>M30</p>  <p>KUM_CDR_03F</p>	<p>M37</p>  <p>KET_SP_04F_W</p>	<p>BLANK</p>

ILLUMINATIONS

ILLUMINATIONS (2)

SD941-2

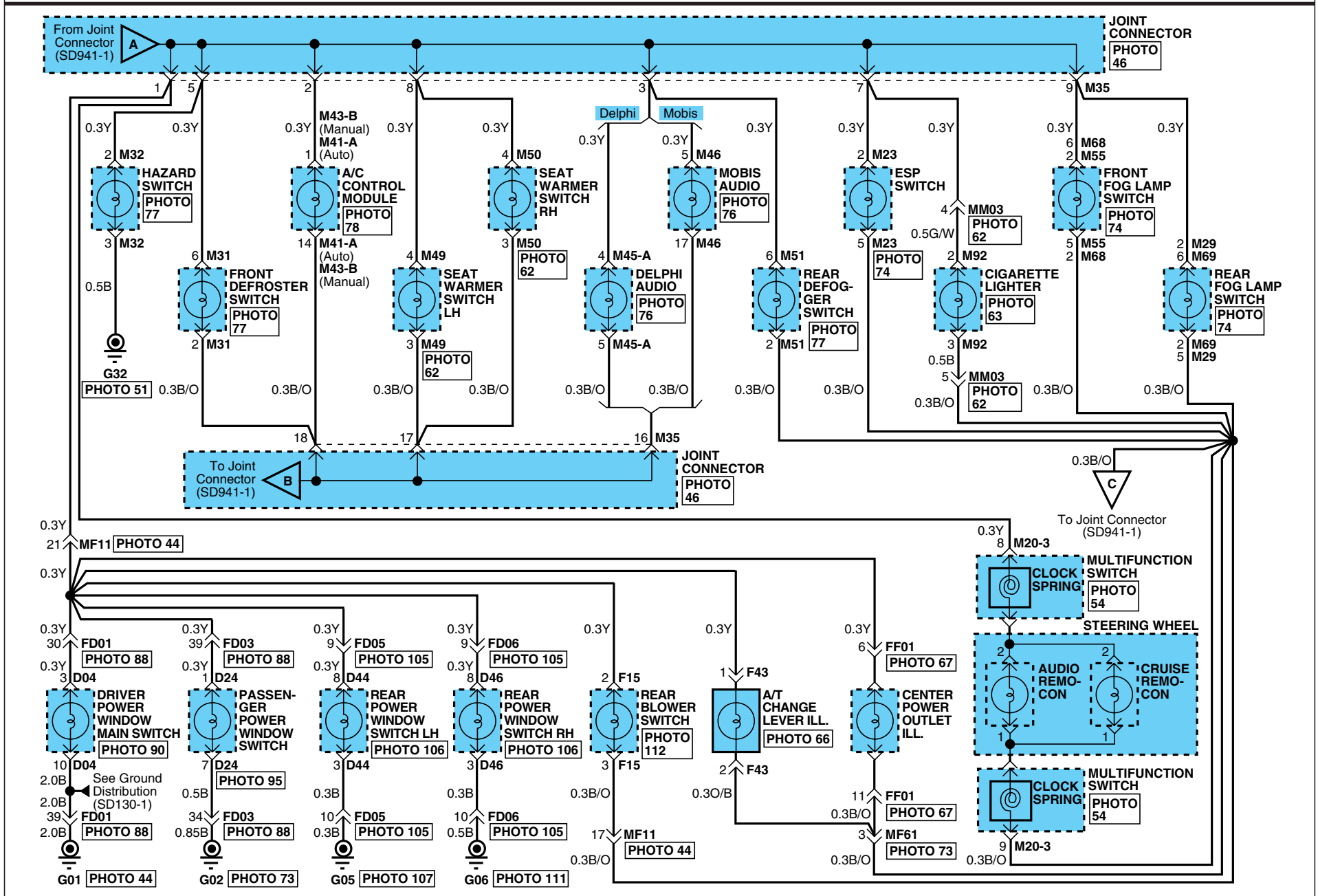

ILLUMINATIONS

ILLUMINATIONS (3)			SD941-3
<p>D04</p> <p>KET_090II_14F_W</p>	<p>D24</p> <p>KET_090II_10F_W</p>	<p>D44</p> <p>KET_090II_08F_W</p>	<p>D46</p> <p>KET_090II_08F_W</p>
<p>F15</p> <p>KET_1809_11F_W_HD</p>	<p>F43</p> <p>KET_090II_02M_Gr_T</p>	<p>ICM-A</p> <p>KET_1809_11F_W_UNIT</p>	<p>M13-B</p> <p>KET_0407_26F_W</p>
<p>M13-D</p> <p>KET_0407_22F_W</p>	<p>M15-A</p> <p>AMP_040M2_20F_B</p>	<p>M16</p> <p>AMP_PLM2_02F_W</p>	<p>M17</p> <p>KET_187_02F_W</p>
<p>M20-2</p> <p>KET_0509_18F_W</p>	<p>M20-2A</p> <p>KET_0509_18F_W</p>	<p>M20-3</p> <p>AMP_025_12F_W</p>	<p>M22</p> <p>KUM_CDR_05F_W</p>
<p>M23</p> <p>KET_090II_06F_G</p>	<p>M24</p> <p>KET_090II_06F_Y</p>	<p>M29</p> <p>KET_090II_06F_L</p>	<p>M31</p> <p>AMP_090III_06F_L</p>

ILLUMINATIONS

ILLUMINATIONS (4)			SD941-4
<p>M32</p> <p>KET_090II_10F_W</p>	<p>M36</p> <p>KET_090III_06F_G</p>	<p>M41-A</p> <p>AMP_0407_26F_W_HD</p>	<p>M43-B</p> <p>KET_0407_26F_W</p>
<p>M45-A</p> <p>PKD_ASM_14F_B</p>	<p>M46</p> <p>KET_0409_24F_W</p>	<p>M49</p> <p>AMP_MQS_08F_W</p>	<p>M50</p> <p>AMP_MQS_08F_B</p>
<p>M51</p> <p>AMP_090III_06F_SW_Y</p>	<p>M55</p> <p>KET_090II_06F_Gr</p>	<p>M58</p> <p>KET_090II_06F_L</p>	<p>M66</p> <p>KET_090II_02F_Gr_T</p>
<p>M67</p> <p>MLX_040III_08F_B</p>	<p>M68</p> <p>AMP_090III_06F_SW_W</p>	<p>M69</p> <p>AMP_090III_06F_L</p>	<p>BLANK</p>

DIGITAL CLOCK & CIGARETTE LIGHTER (POWER OUTLET) (1)

SD945-1

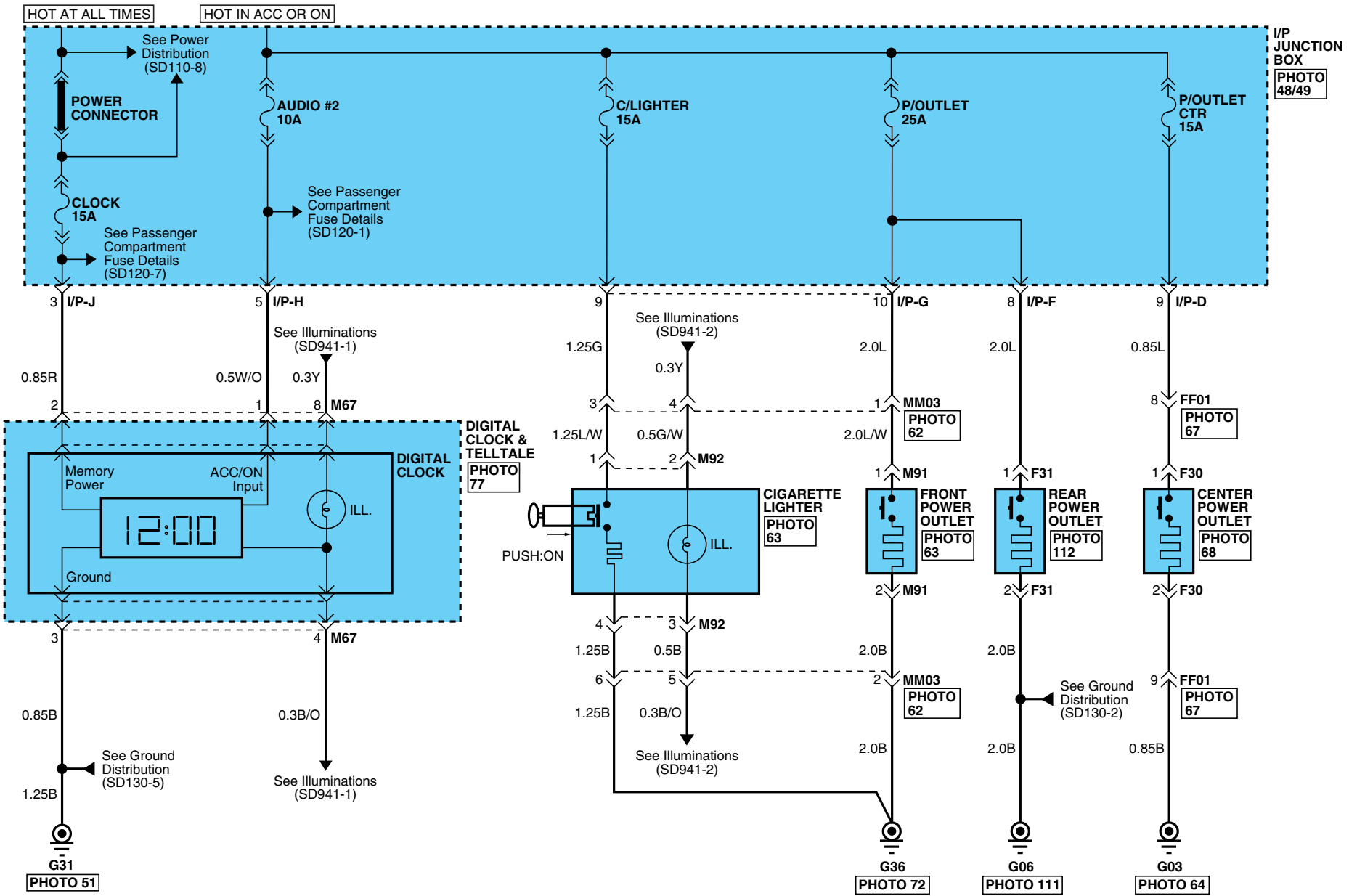

DIGITAL CLOCK & CIGARETTE LIGHTER (POWER OUTLET)

DIGITAL CLOCK & CIGARETTE LIGHTER (POWER OUTLET) (2)

SD945-2

F30

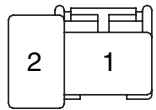

AMP_PLM2_02F_B

F31

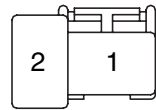

AMP_PLM2_02F_B

M67

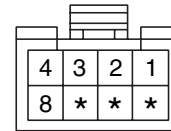

MLX_040III_08F_B

BLANK

BCM (BODY CONTROL MODULE) SYSTEM (1)

SD950-1

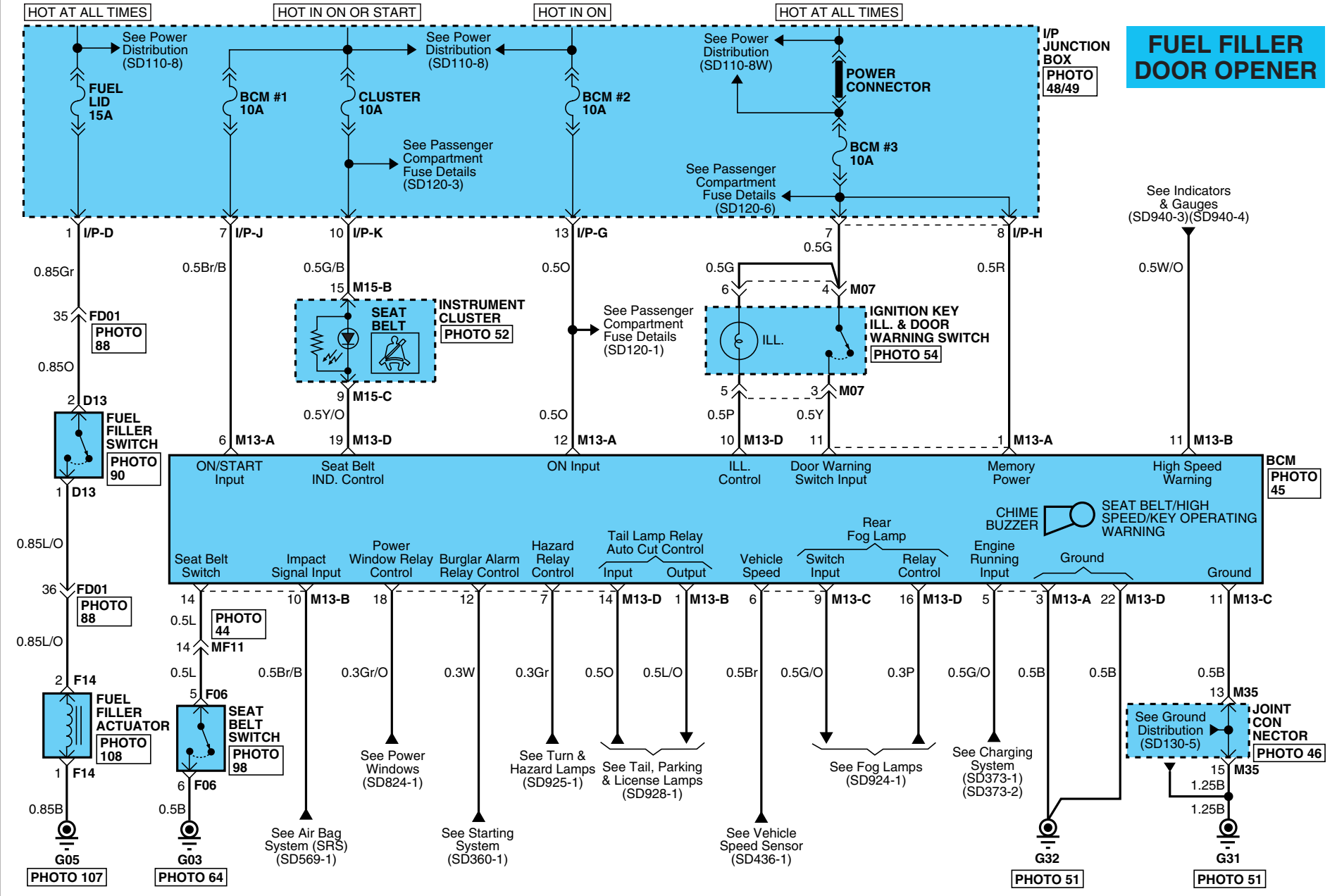

BCM (BODY CONTROL MODULE) SYSTEM

BCM (BODY CONTROL MODULE) SYSTEM (2)

SD950-2

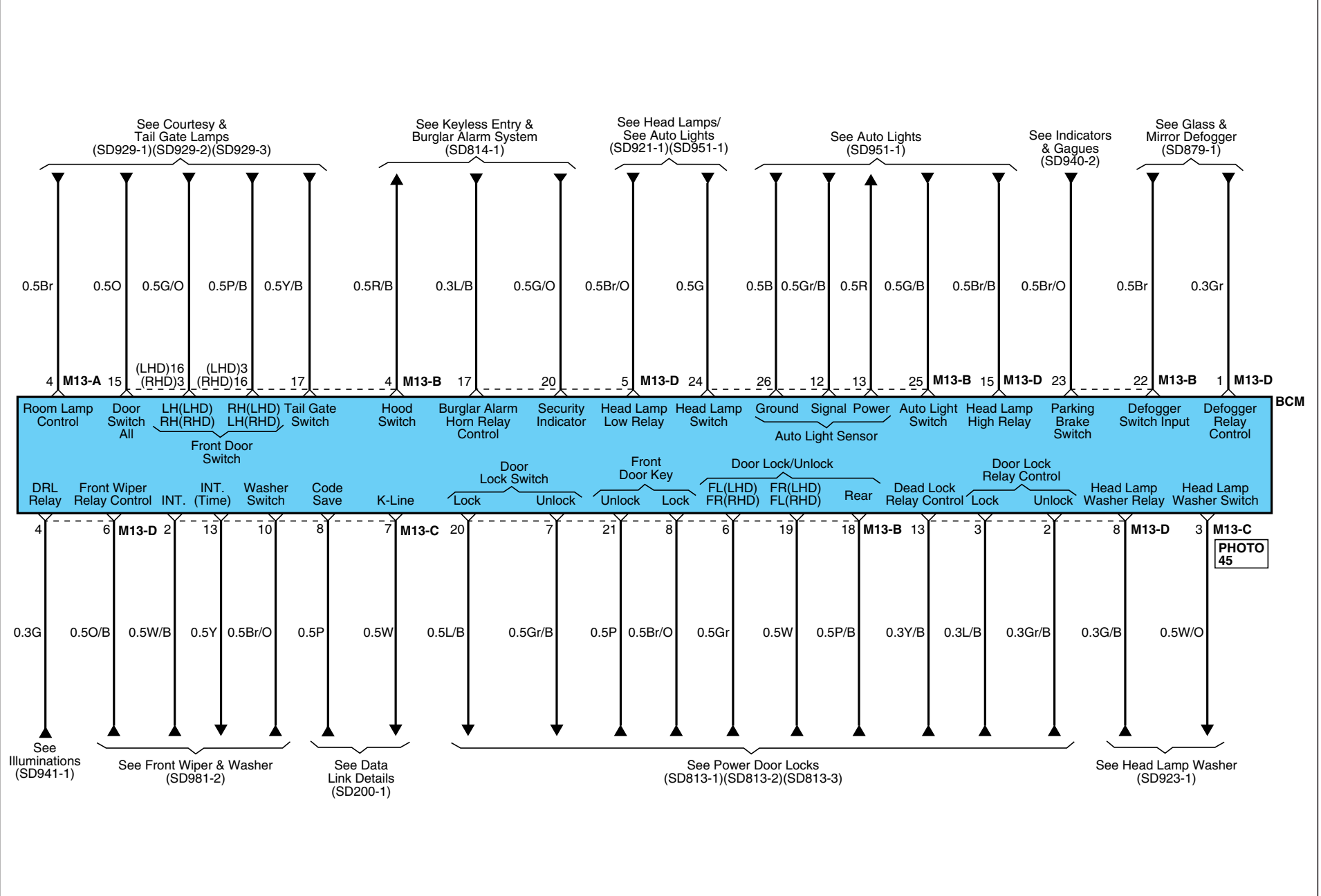

BCM (BODY CONTROL MODULE) SYSTEM

BCM (BODY CONTROL MODULE) SYSTEM (3)

SD950-3

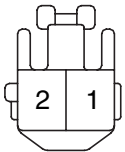
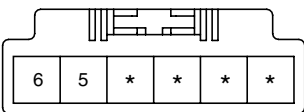
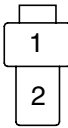
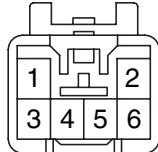
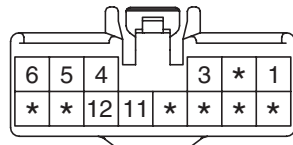
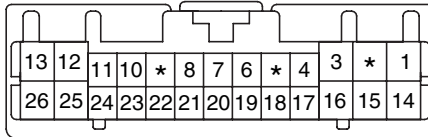
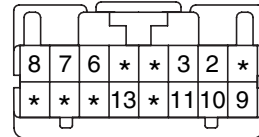
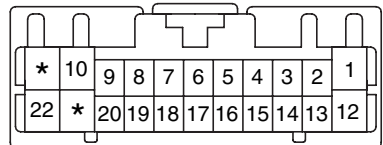
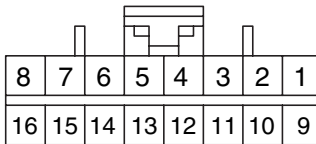
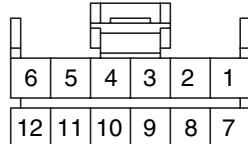
<p>D13</p>  <p>KET_090II_02F_Gr_T</p>	<p>F06</p>  <p>AMP_ABAG_06F_Y</p>	<p>F14</p>  <p>AMP_250_02F_B</p>	<p>M07</p>  <p>KET_090II_06M_W</p>
<p>M13-A</p>  <p>KET_090II_14F_W</p>	<p>M13-B</p>  <p>KET_0407_26F_W</p>	<p>M13-C</p>  <p>KET_0407_16F_W</p>	<p>M13-D</p>  <p>KET_0407_22F_W</p>
<p>M15-B</p>  <p>AMP_040M2_16F_B</p>	<p>M15-C</p>  <p>AMP_040M1_12F_B</p>	<p>BLANK</p>	<p>BLANK</p>

BCM (BODY CONTROL MODULE) SYSTEM

BCM (BODY CONTROL MODULE) SYSTEM (4)

SD950-4

MEMO

AUTO LIGHTS (1)

SD951-1

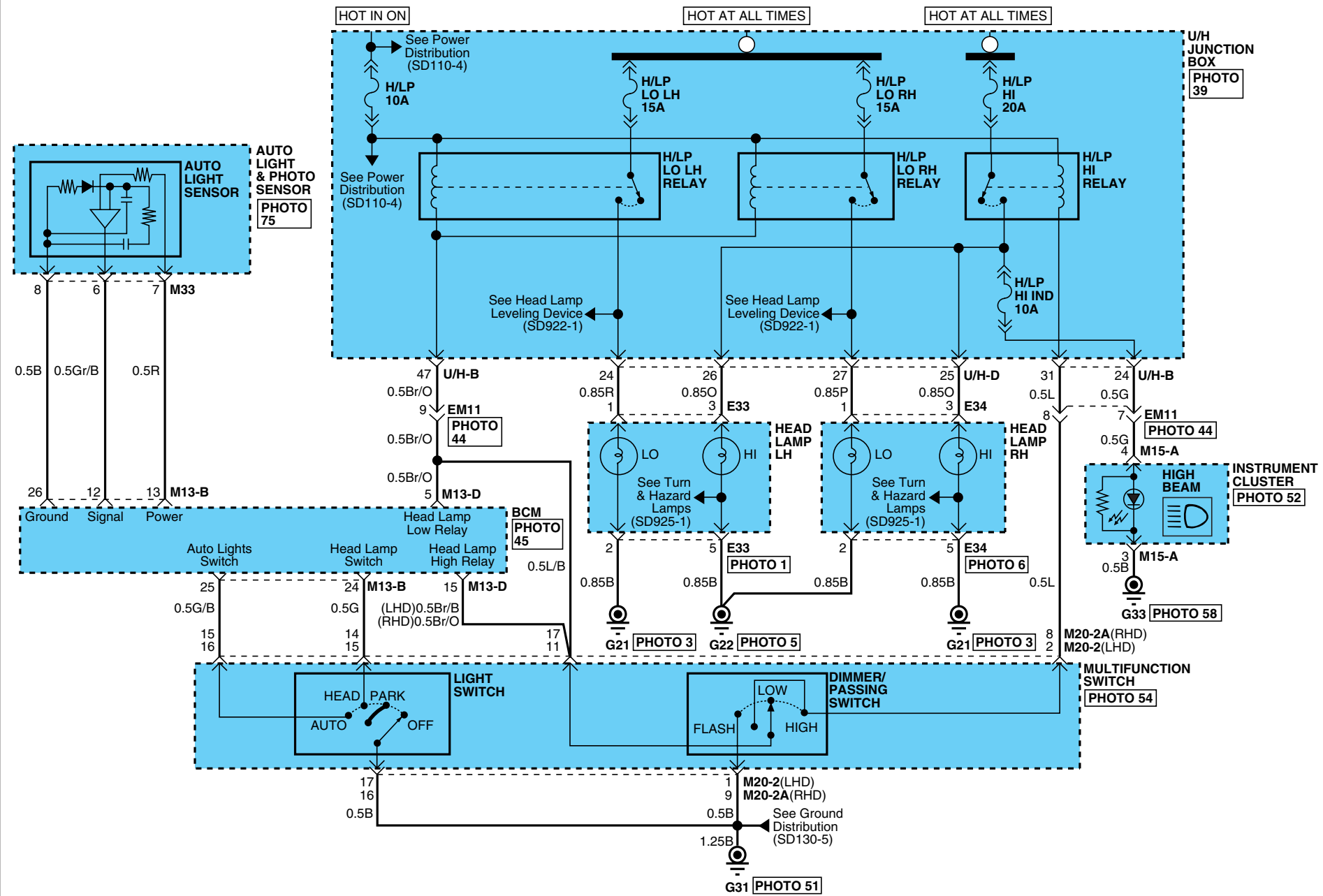

AUTO LIGHTS

AUTO LIGHTS (2)

SD951-2

E33



KUM_NMWP_06F_B

E34



KUM_NMWP_06F_B

M13-B

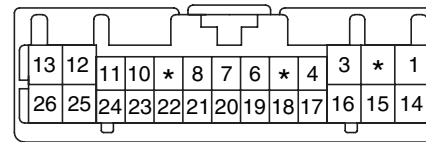

KET_0407_26F_W

M13-D

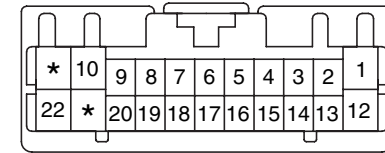

KET_0407_22F_W

M15-A

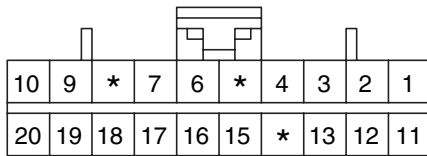

AMP_040M2_20F_B

M20-2

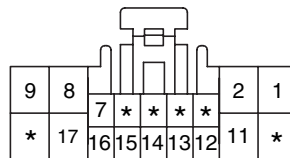

KET_0509_18F_W

M20-2A

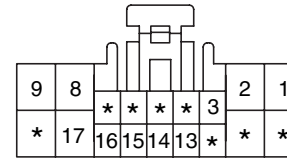

KET_0509_18F_W

M33

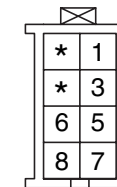

KET_030_08F_Br

IMMOBILIZER CONTROL SYSTEM (1)

SD954-1

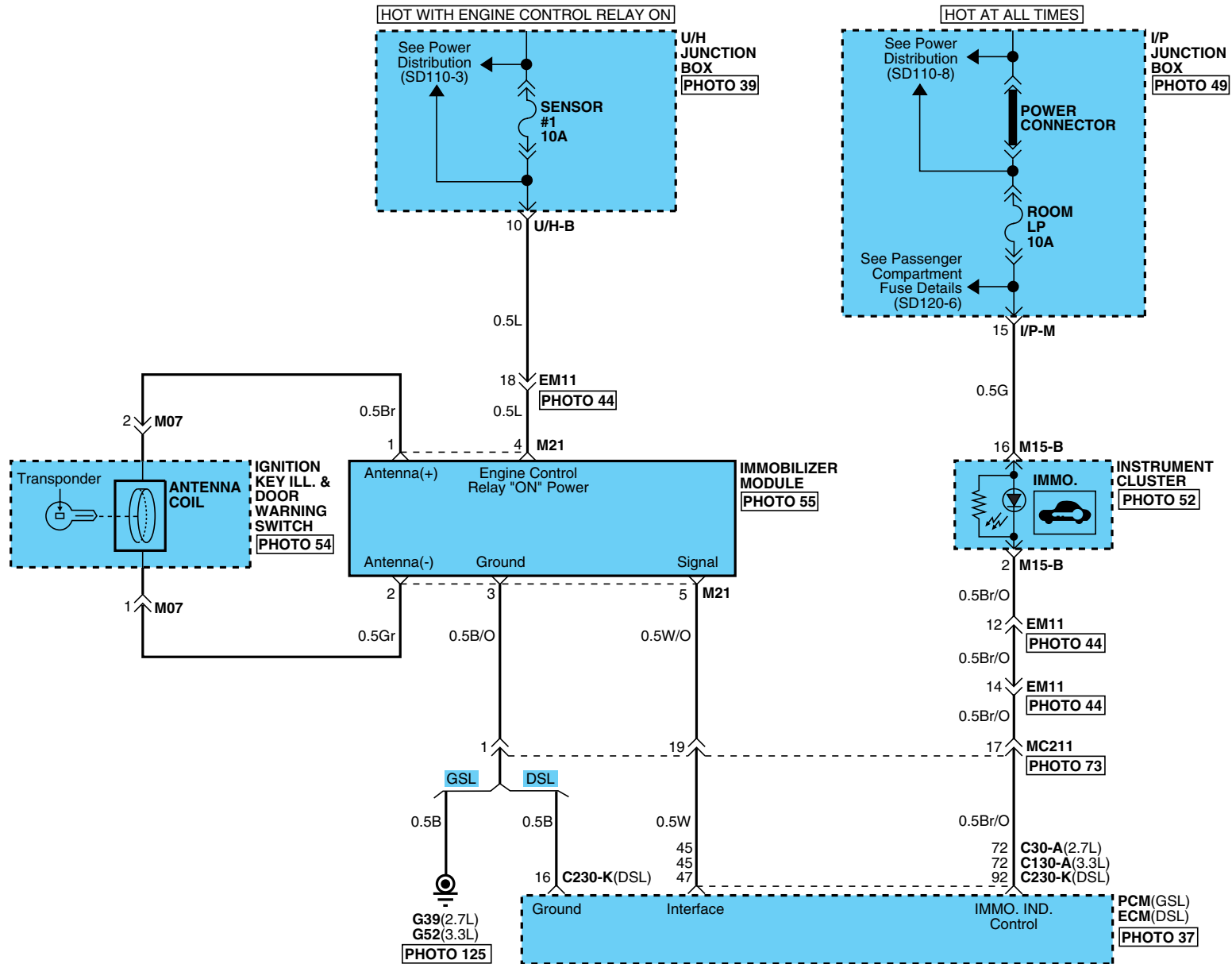

IMMOBILIZER CONTROL SYSTEM

IMMOBILIZER CONTROL SYSTEM (2)

SD954-2

C30-A

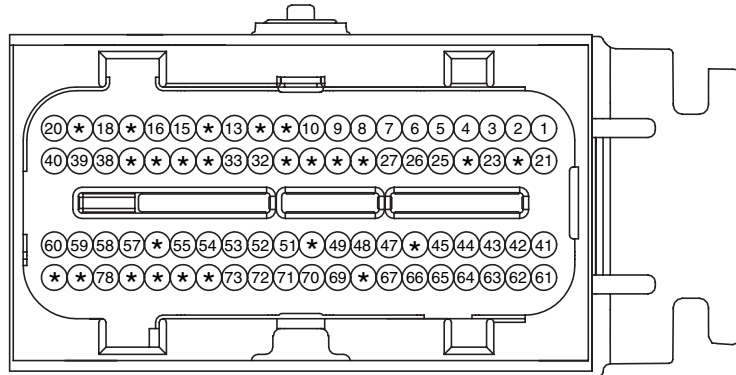

PKD_ECU_80F_Gr_NR

C130-A

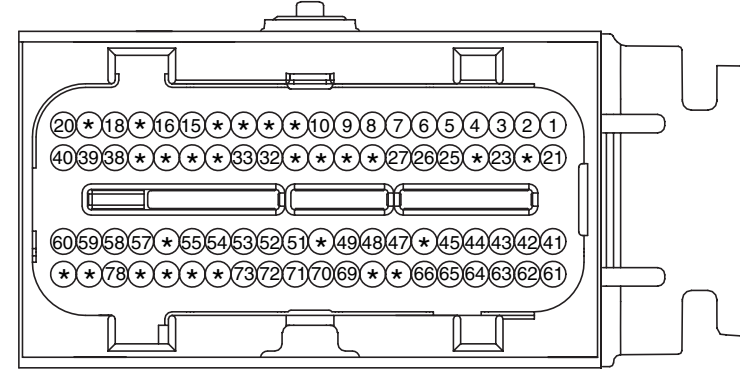

PKD_ECU_80F_Gr_3

C230-K

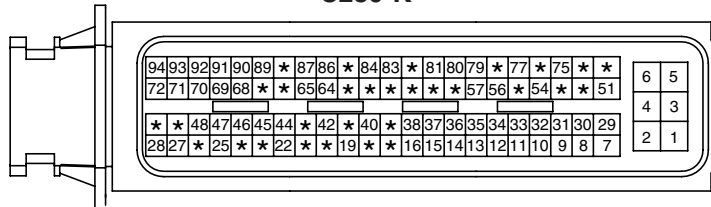

AMP_ECU_94F_B

M07

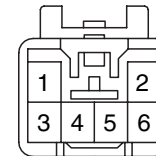

KET_090II_06M_W

M15-B

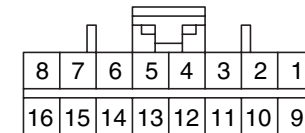

AMP_040M2_16F_B

M21

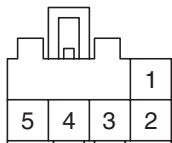

KUM_CDR_05F_W

BLANK

BLANK

BLANK

REAR PARKING ASSIST SYSTEM (1)

SD957-1

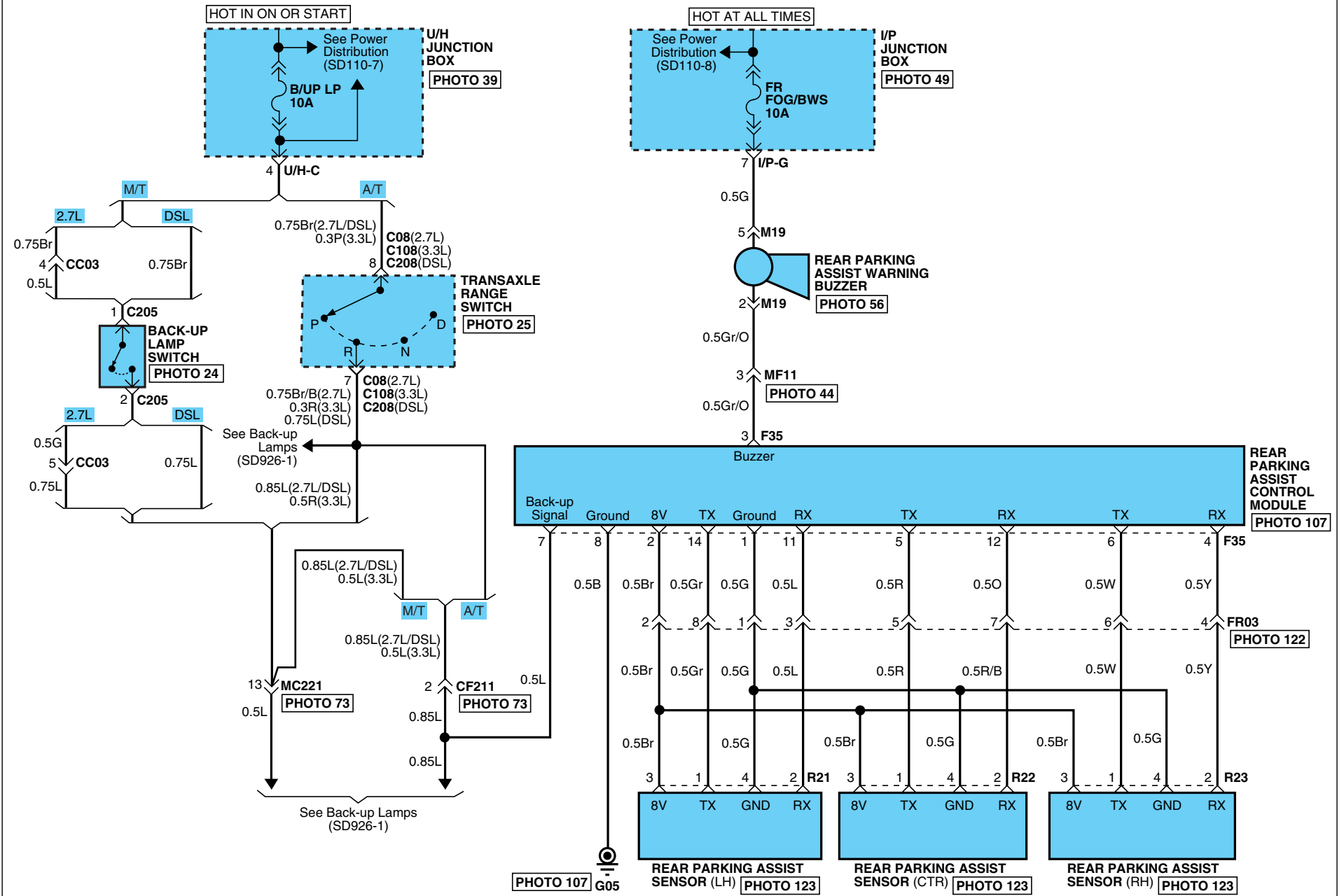

REAR PARKING ASSIST SYSTEM

REAR PARKING ASSIST SYSTEM (2)

SD957-2

C205

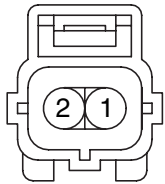

AMP_EJWP_02F_B

C208



KET_SSD_10F_B_A

F35

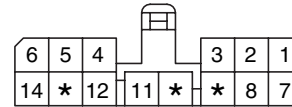

AMP_070_14F_W

M19

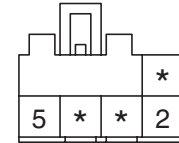

KUM_CDR_05F_W

R21

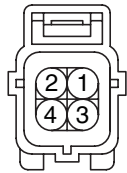

AMP_EJWP_04F_B

R22

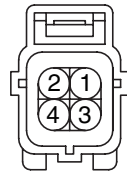

AMP_EJWP_04F_B

R23



AMP_EJWP_04F_B

BLANK

AUDIO SYSTEM (1)

SD961-1

**MOBIS AMP+
MOBIS AUDIO**

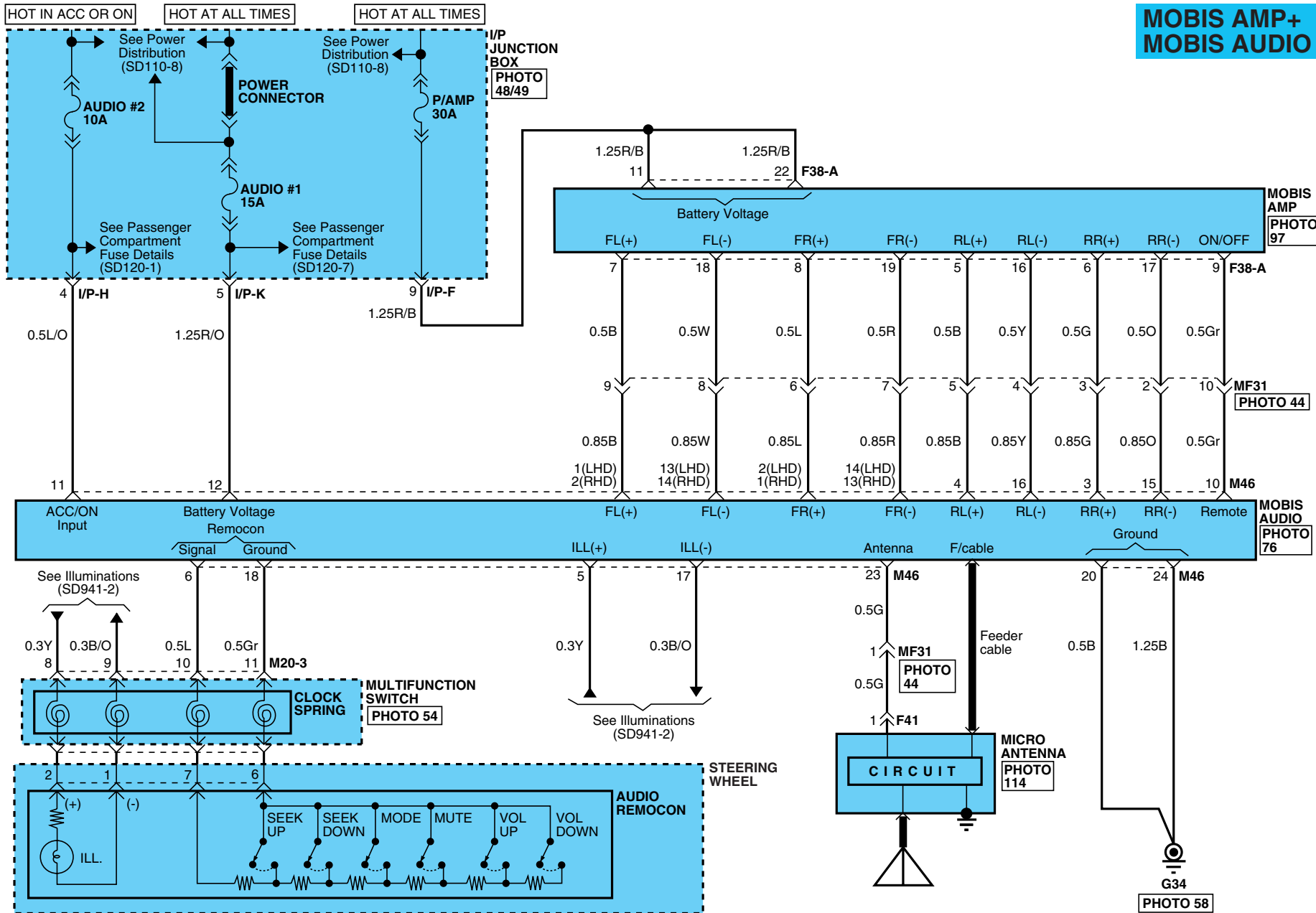

AUDIO SYSTEM

AUDIO SYSTEM (2)

SD961-2

**MOBIS AMP+
MOBIS AUDIO**

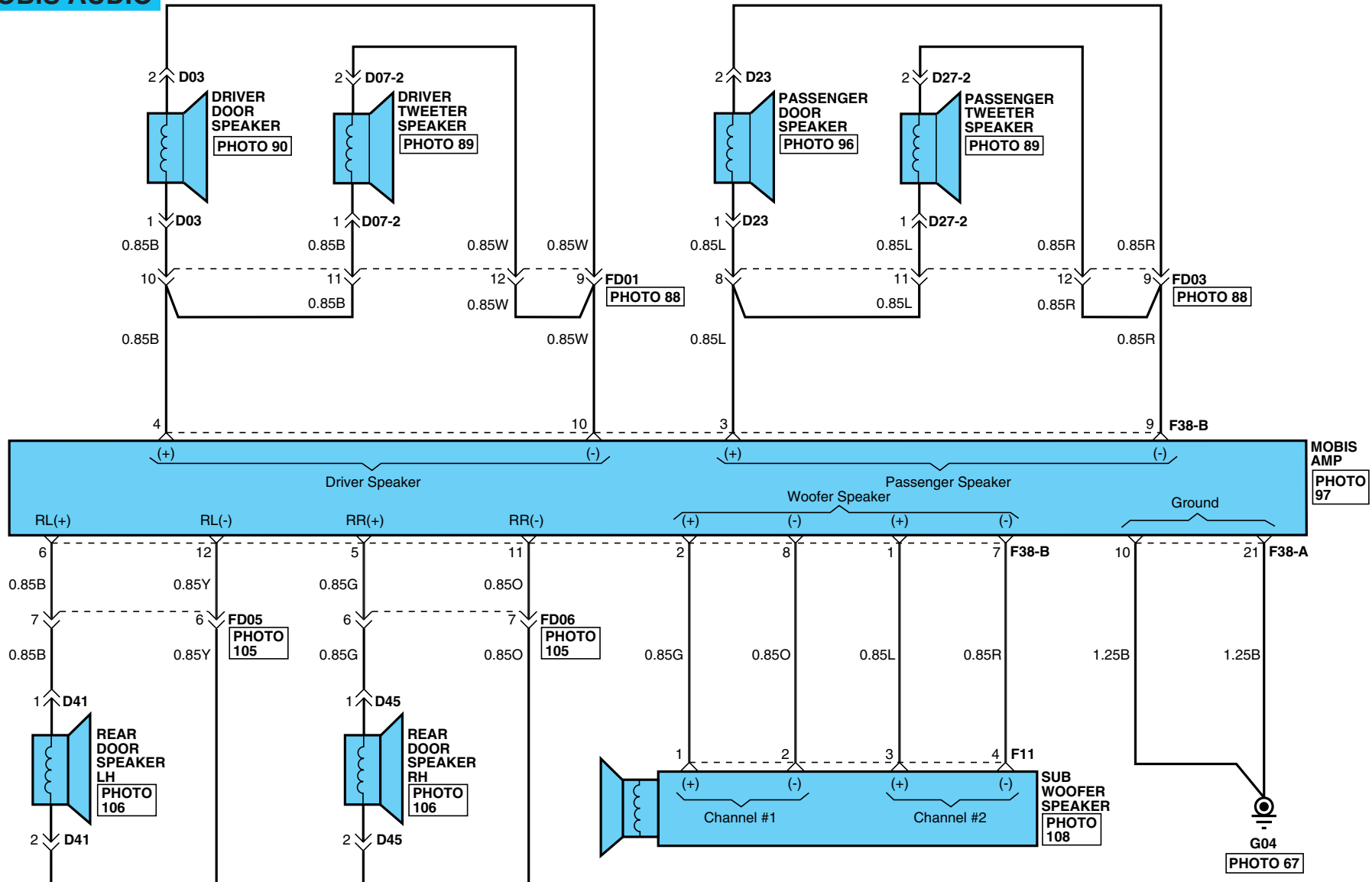

AUDIO SYSTEM

AUDIO SYSTEM (4)

SD961-4

DELPHI AMP+ MOBIS AUDIO

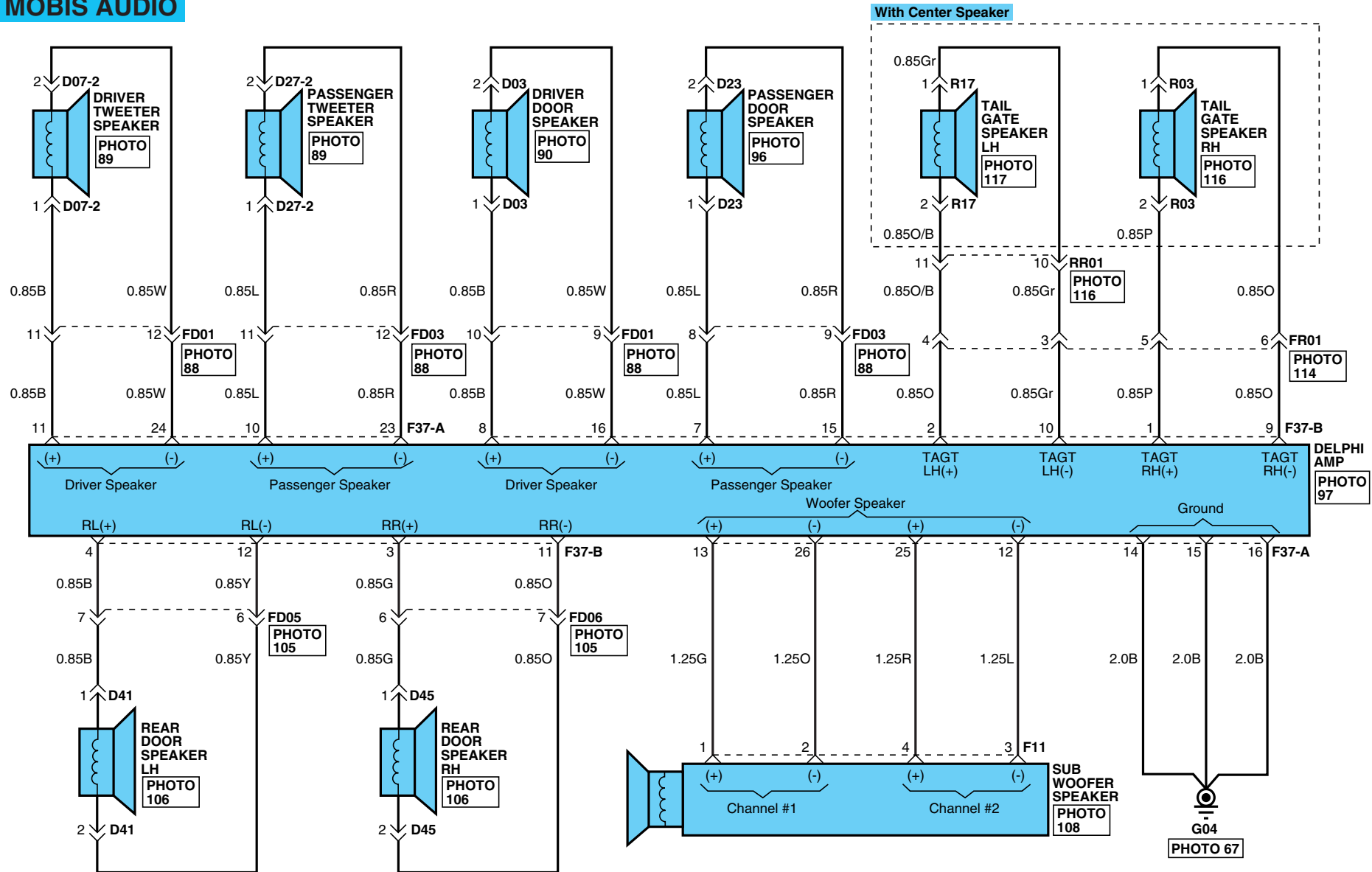

AUDIO SYSTEM

AUDIO SYSTEM (5)

SD961-5

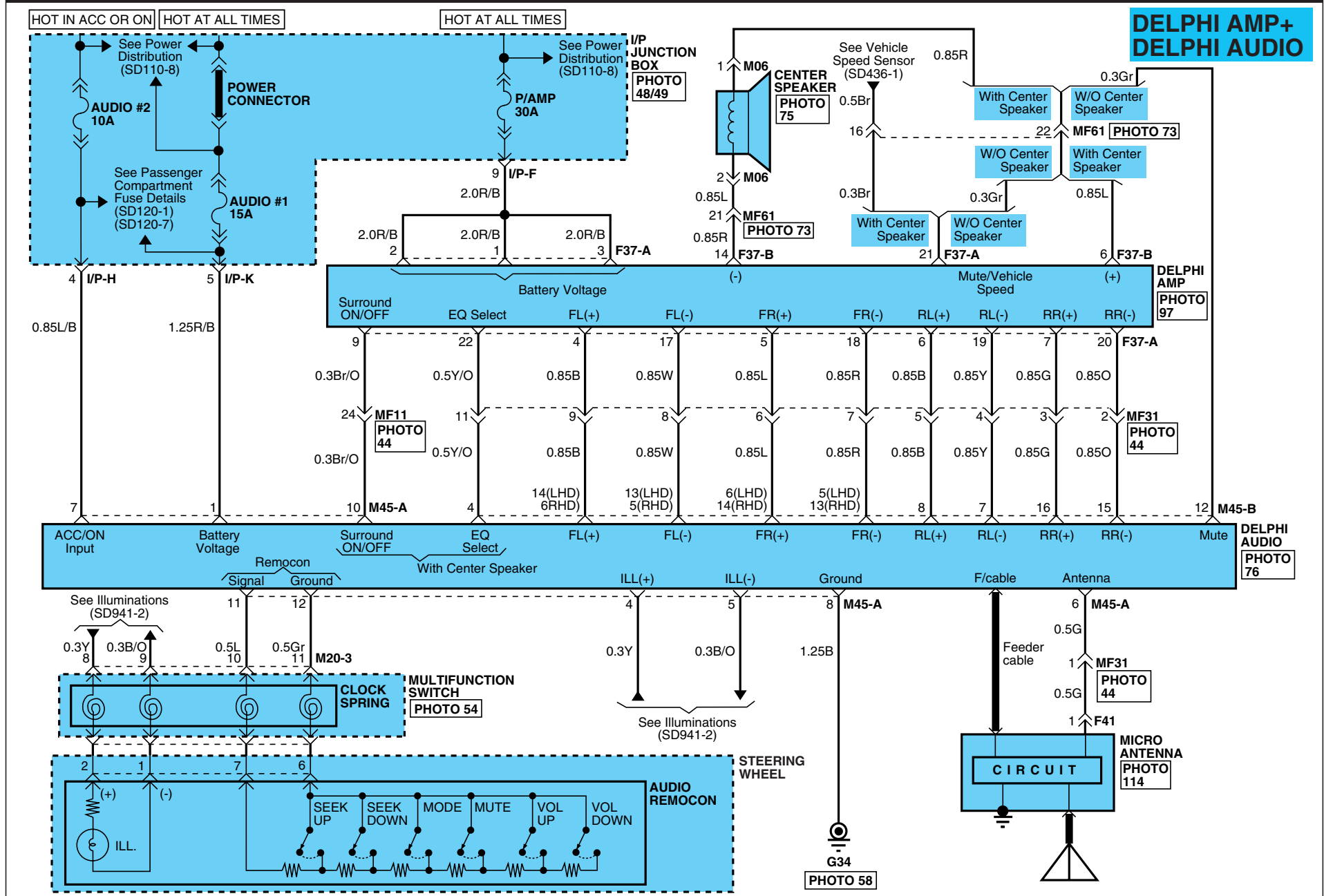

AUDIO SYSTEM

AUDIO SYSTEM (6)

SD961-6

DELPHI AMP+ DELPHI AUDIO

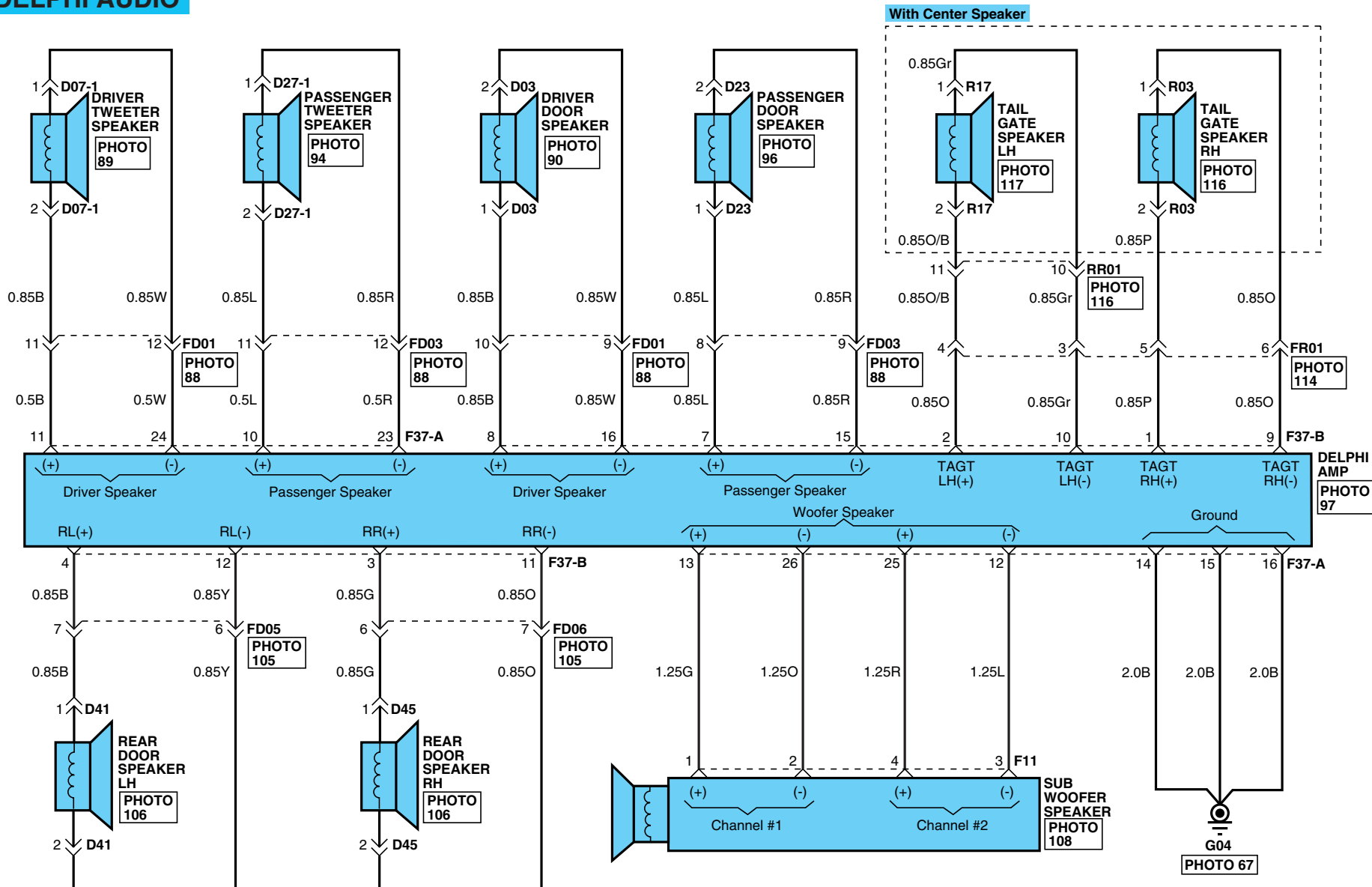

AUDIO SYSTEM

AUDIO SYSTEM (7)

SD961-7

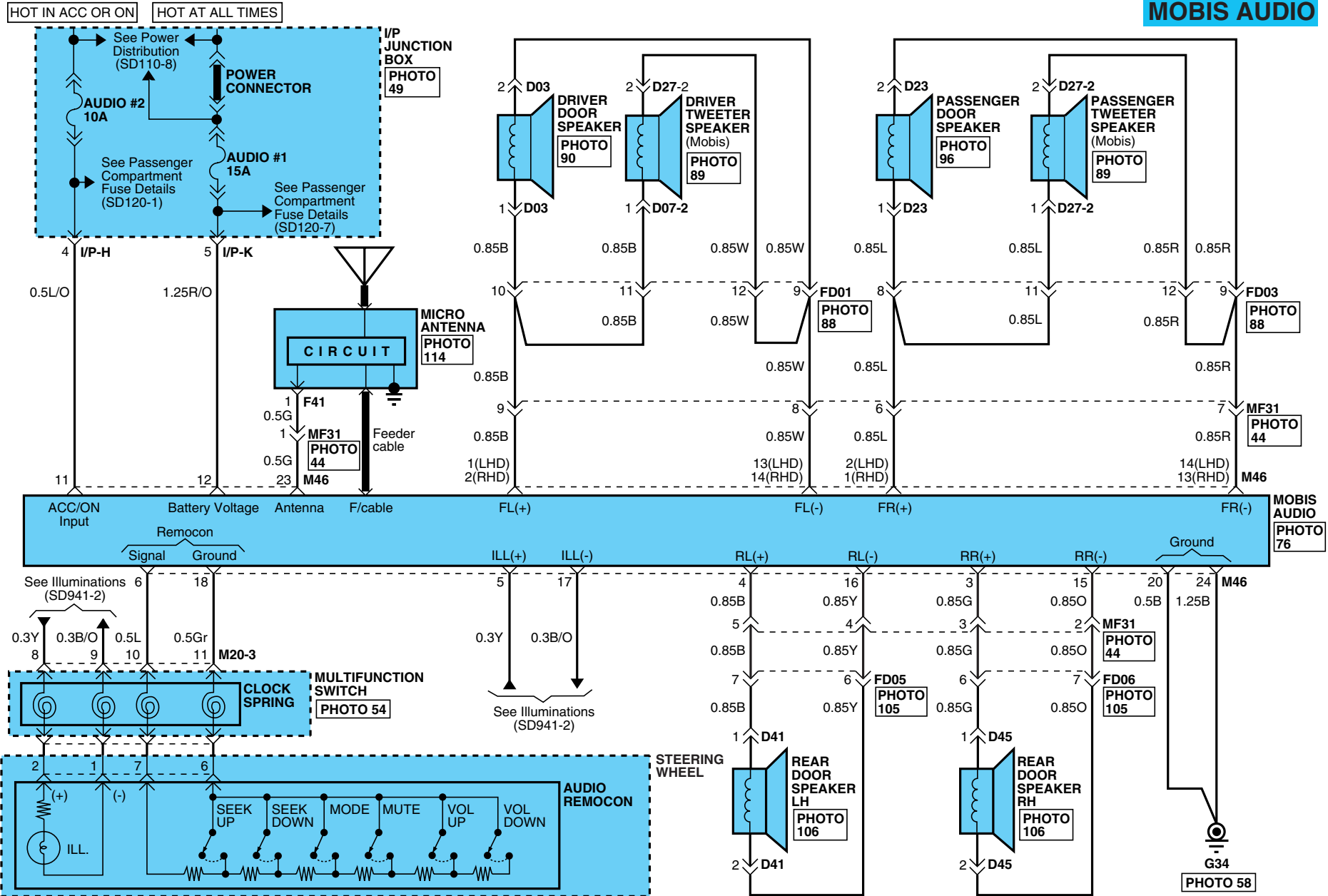

MOBIS AUDIO



AUDIO SYSTEM

AUDIO SYSTEM (8)

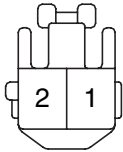
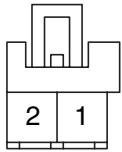
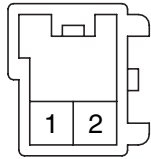
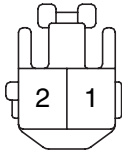
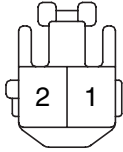
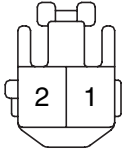
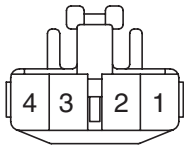
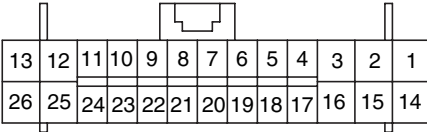
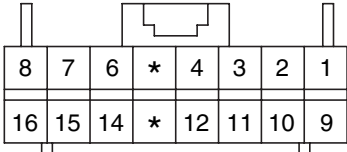
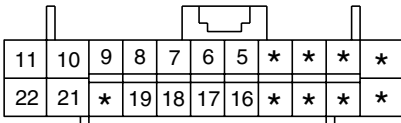
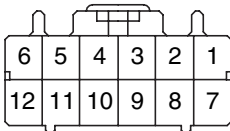
SD961-8

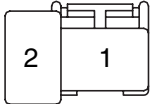
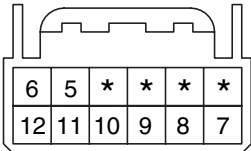
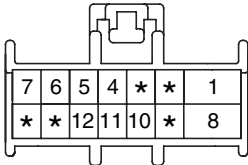
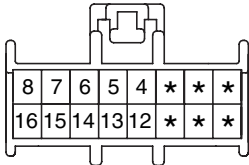
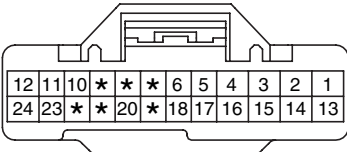
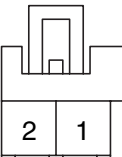
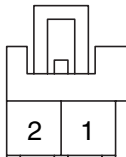
<p>D03</p>  <p>KET_090II_02F_W_L</p>	<p>D07-1/D27-1</p>  <p>KUM_CDR_02F_W</p>	<p>D07-2/D27-2</p>  <p>KUM_CDR_02M_B</p>	<p>D23</p>  <p>KET_090II_02F_W_L</p>
<p>D41</p>  <p>KET_090II_02F_W_L</p>	<p>D45</p>  <p>KET_090II_02F_W_L</p>	<p>F11</p>  <p>KET_090II_04F_W</p>	<p>F37-A</p>  <p>AMP_0407_26F_Gr_HD</p>
<p>F37-B</p>  <p>AMP_0407_16F_Gr_040</p>	<p>F38-A</p>  <p>AMP_0407_22F_W_HD</p>	<p>F38-B</p>  <p>AMP_0407_12F_W_070</p>	<p>F41</p>  <p>AMP_PLM2_01F_B</p>
<p>M06</p>  <p>AMP_PLM2_02F_B</p>	<p>M20-3</p>  <p>AMP_025_12F_W</p>	<p>M45-A</p>  <p>PKD_ASM_14F_B</p>	<p>M45-B</p>  <p>PKD_ASM_16F_B</p>
<p>M46</p>  <p>KET_0409_24F_W</p>	<p>R03</p>  <p>KUM_CDR_02F_W</p>	<p>R17</p>  <p>KUM_CDR_02F_W</p>	<p>BLANK</p>

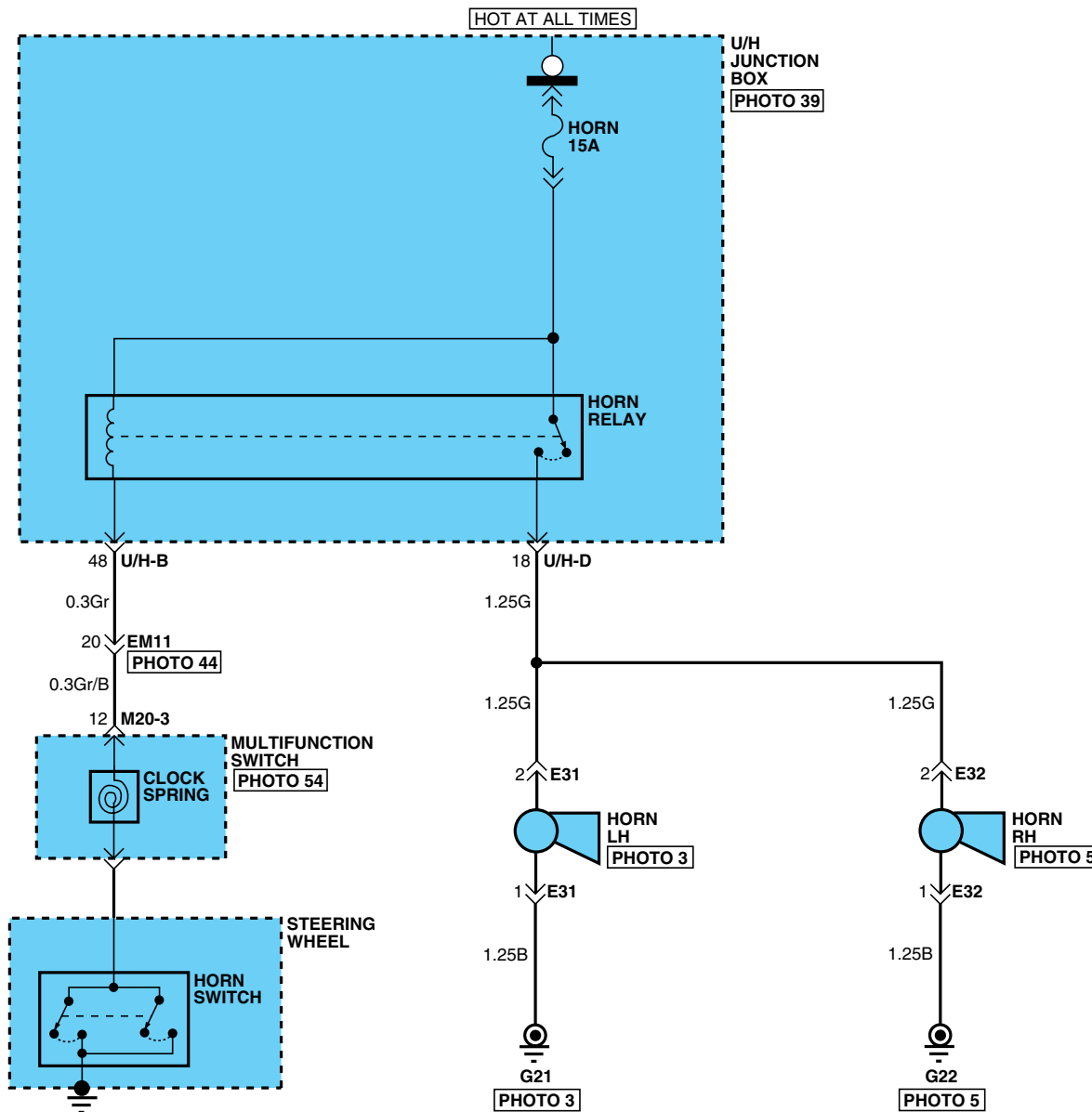

HORNS

HORNS (2)

SD968-2

E31

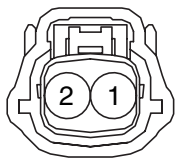

MLX_HORN_02F_B_FILT

E32

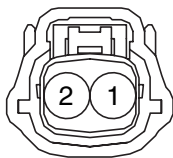

MLX_HORN_02F_B_FILT

M20-3

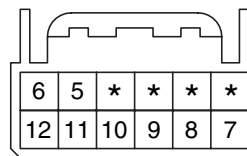

AMP_025_12F_W

BLANK

BLOWER & A/C CONTROLS (AUTO) (1)

SD971-1

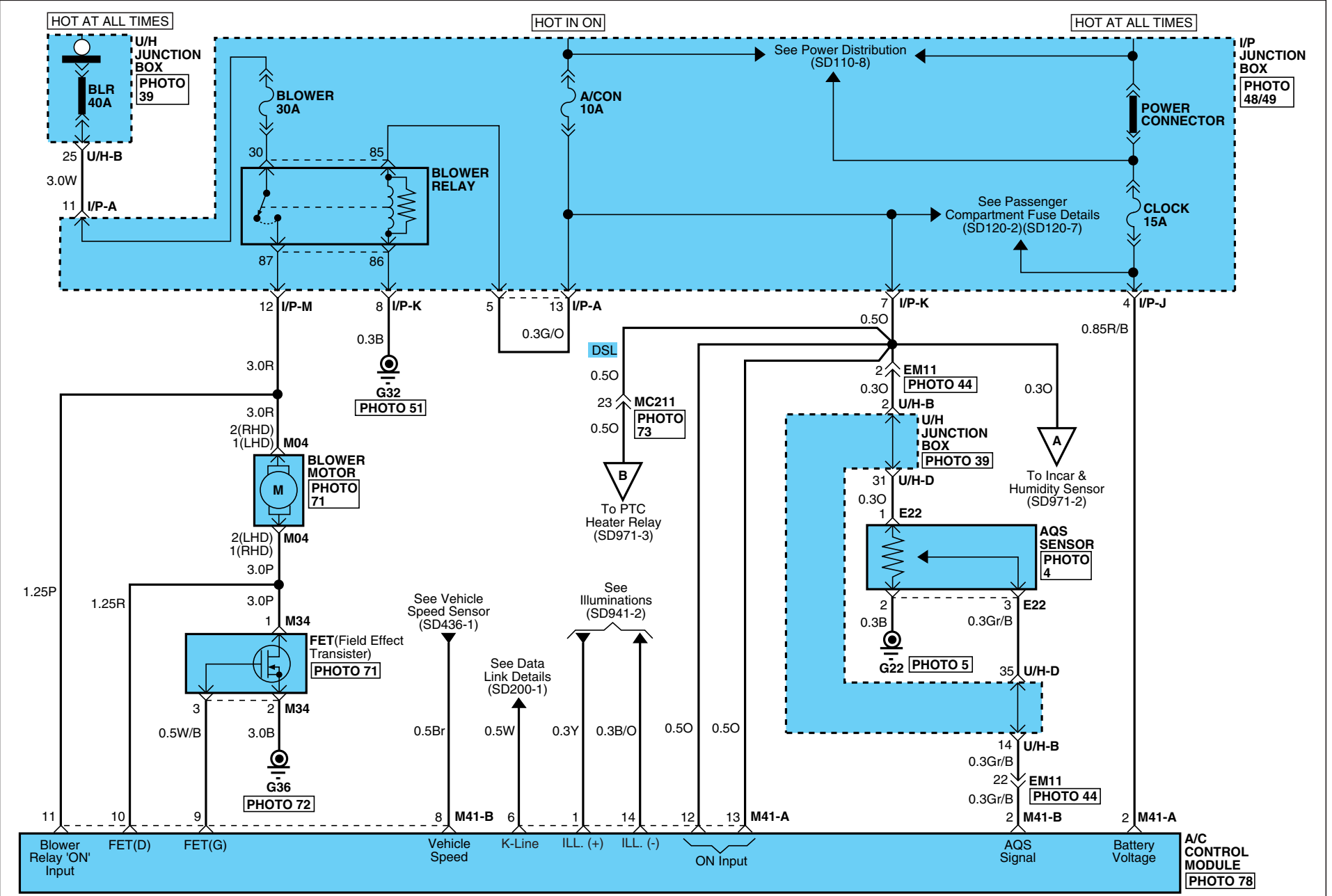

BLOWER & A/C CONTROLS

BLOWER & A/C CONTROLS (AUTO) (2)

SD971-2

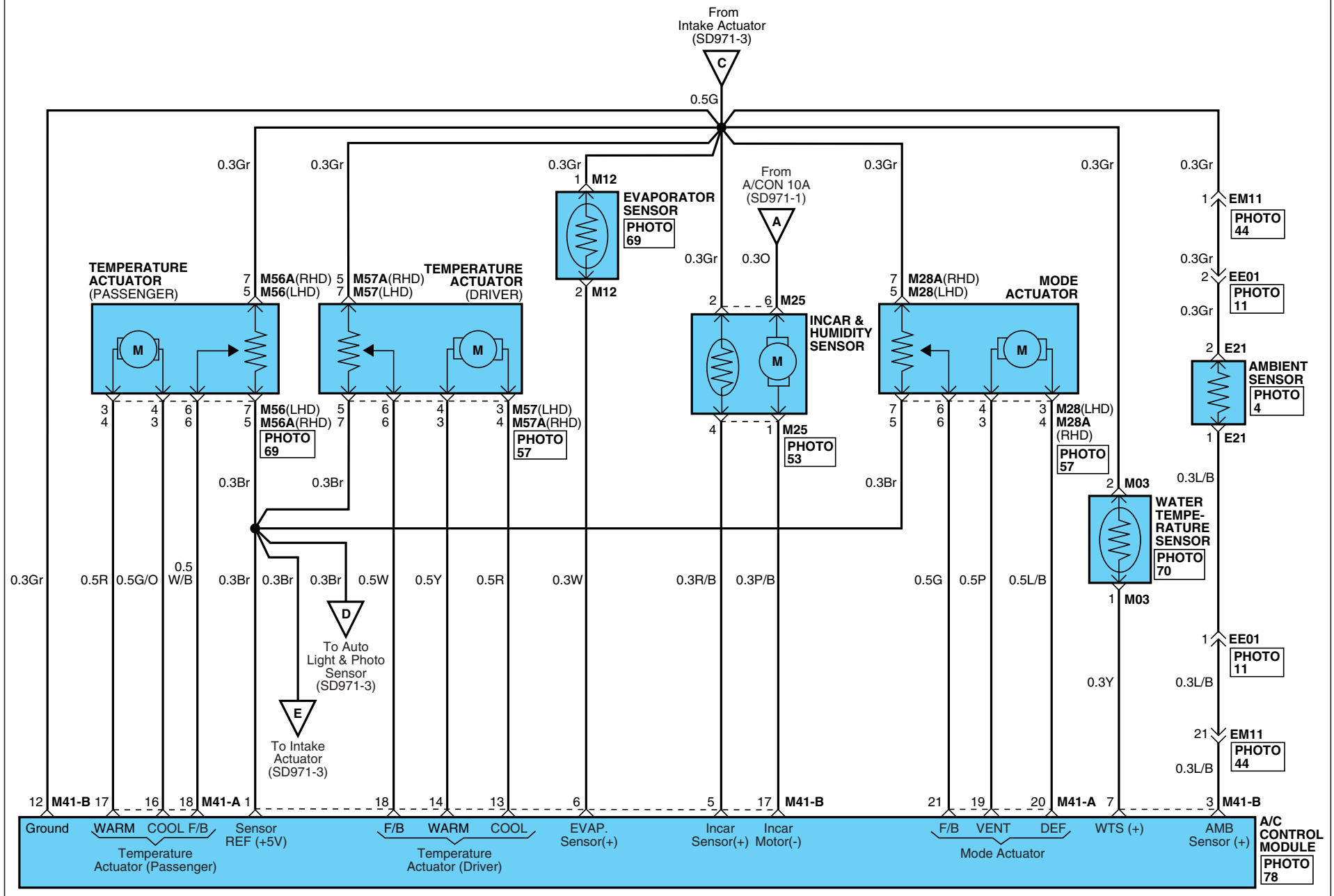

BLOWER & A/C CONTROLS

BLOWER & A/C CONTROLS (AUTO) (3)

SD971-3

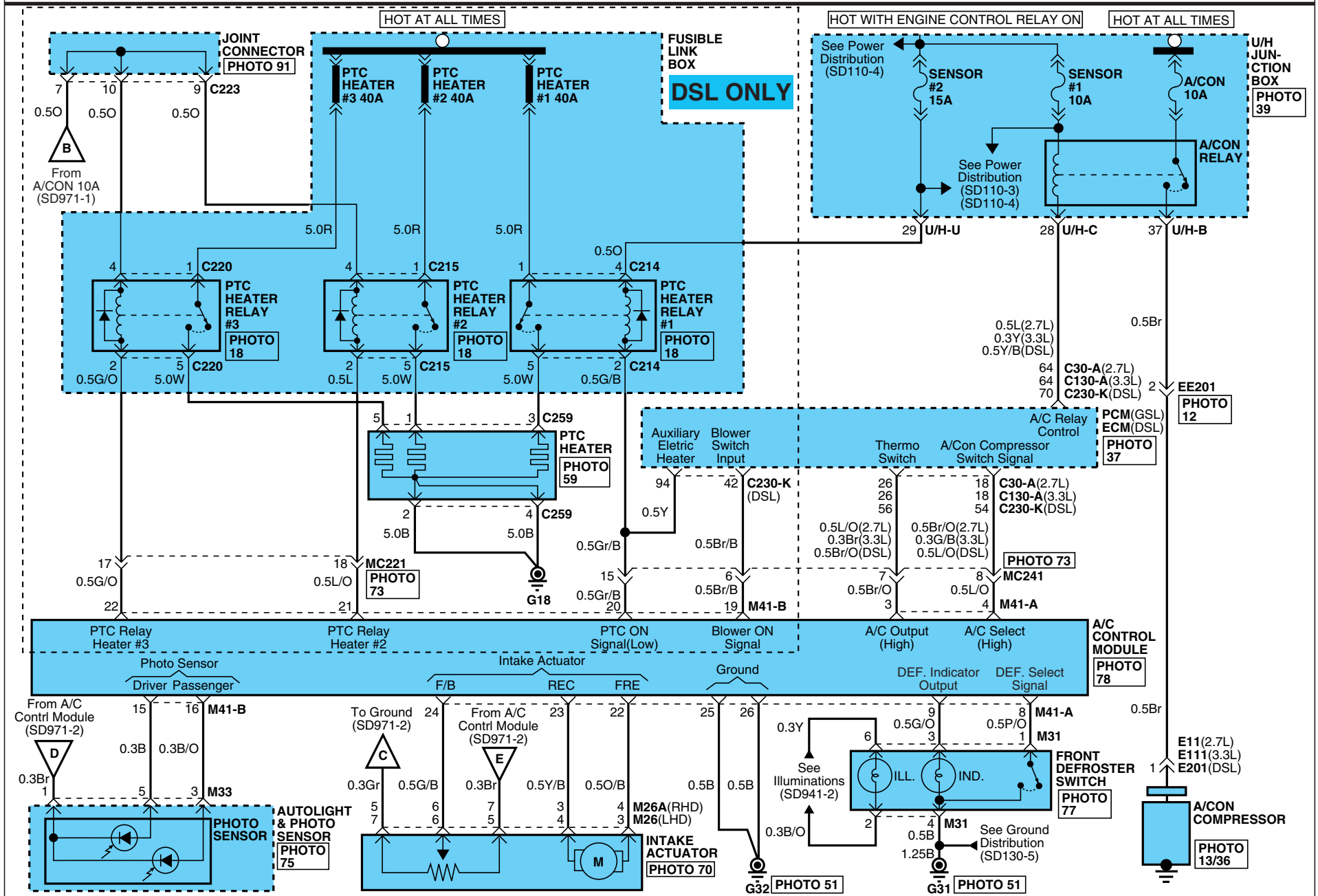

BLOWER & A/C CONTROLS

BLOWER & A/C CONTROLS (AUTO) (4)

SD971-4

C30-A

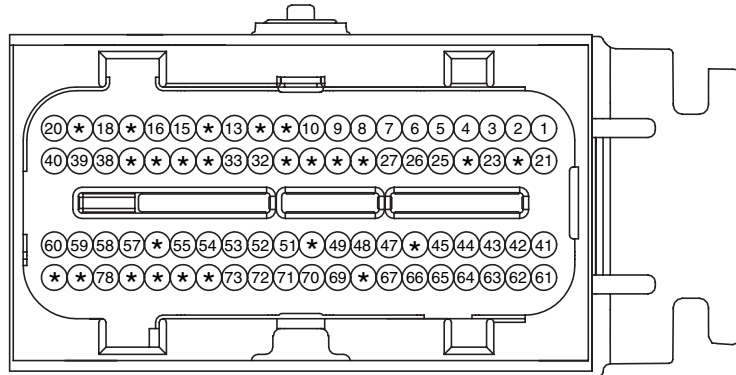

PKD_ECU_80F_Gr_NR

C130-A

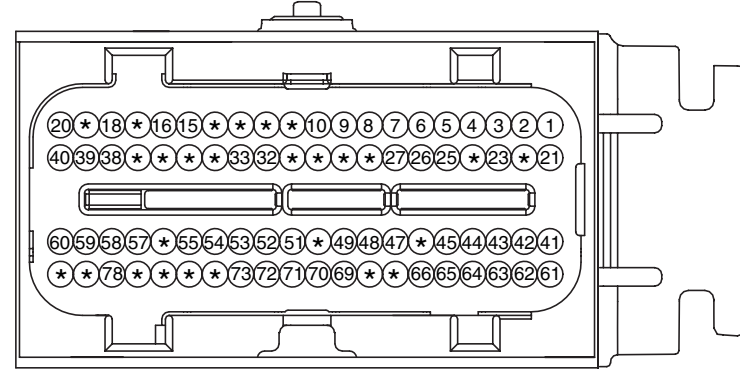

PKD_ECU_80F_Gr_3

C214

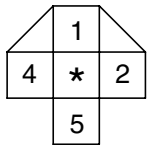

CR05F031

C215

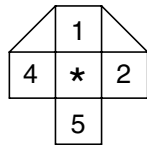

CR05F031

C220

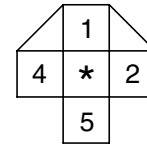

CR05F031

C259

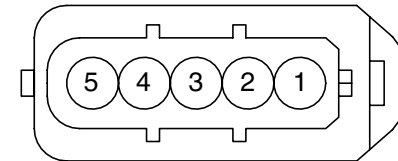

AMP_375_05F_B

C230-K

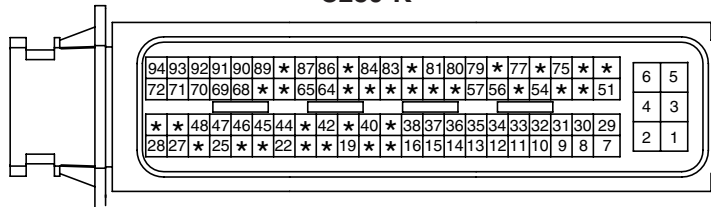

AMP_ECU_94F_B

E11



PB625_01027

E21

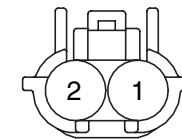

KET_SWP_02F_B

E22

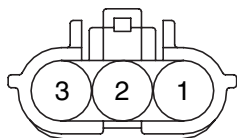

KET_SWP_03F_B

E111



PB625_01027

E201



PB625_01027

M03

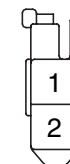

KET_090II_02F_B_SPK

BLOWER & A/C CONTROLS

BLOWER & A/C CONTROLS (AUTO) (5)

SD971-5

M04



KET_250_02F_W

M12

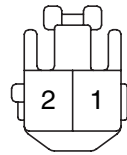

KET_090II_02F_W_L

M25

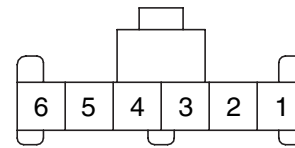

KET_91A_06F_W

M26/M26A

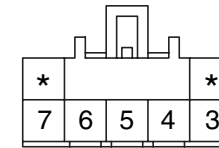

KUM_CDR_07F_B

M28/M28A

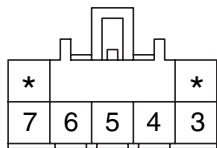

KUM_CDR_07F_W

M31

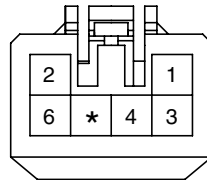

AMP_090III_06F_L

M33

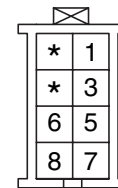

KET_030_08F_Br

M34

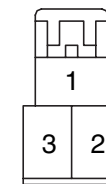

KUM_DSD_03F_B

M41-A

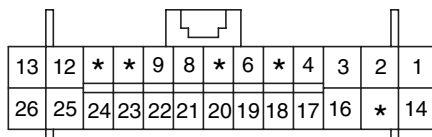

AMP_0407_26F_W_HD

M41-B

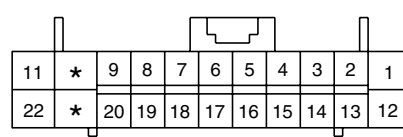

AMP_0407_22F_W

M56/M56A

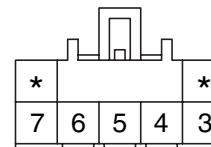

KUM_CDR_07F_W

M57/M57A

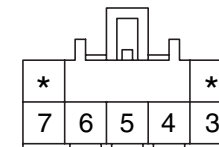

KUM_CDR_07F_B

BLOWER & A/C CONTROLS

BLOWER & A/C CONTROLS (AUTO) (6)

SD971-6

MEMO

BLOWER & A/C CONTROLS (MANUAL) (1)

SD971-7

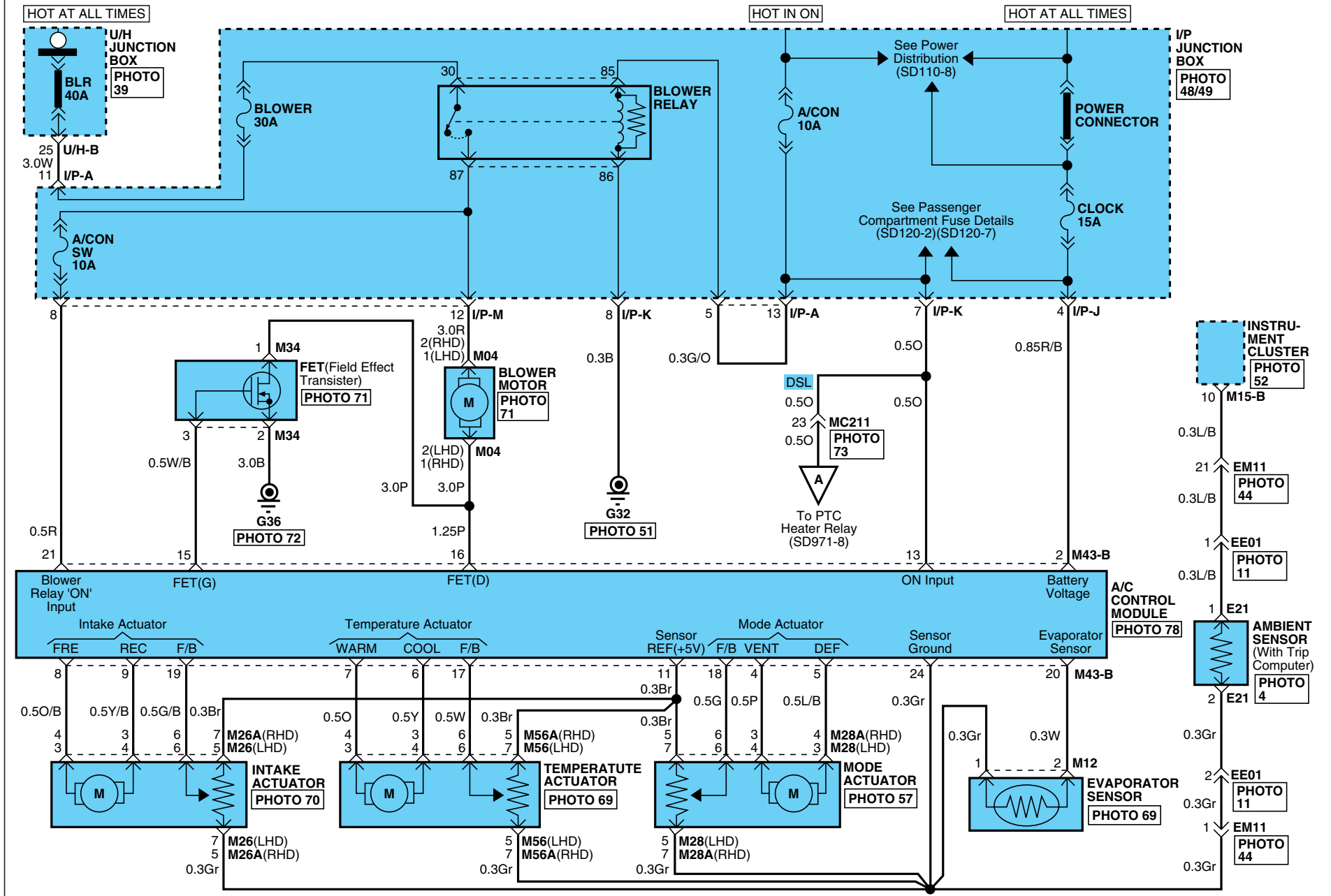

BLOWER & A/C CONTROLS

BLOWER & A/C CONTROLS (MANUAL) (3)

SD971-9

C30-A

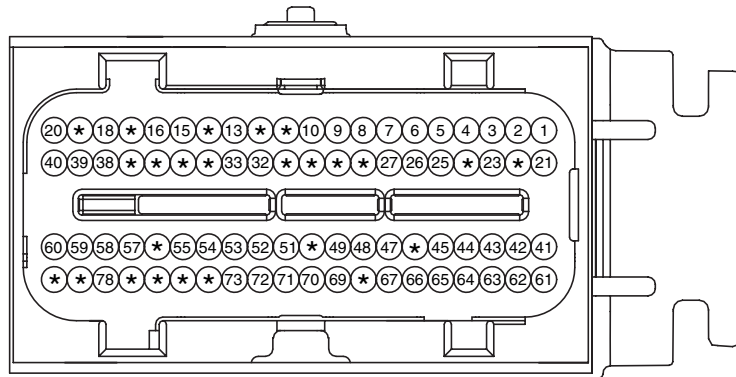

PKD_ECU_80F_Gr_NR

C130-A

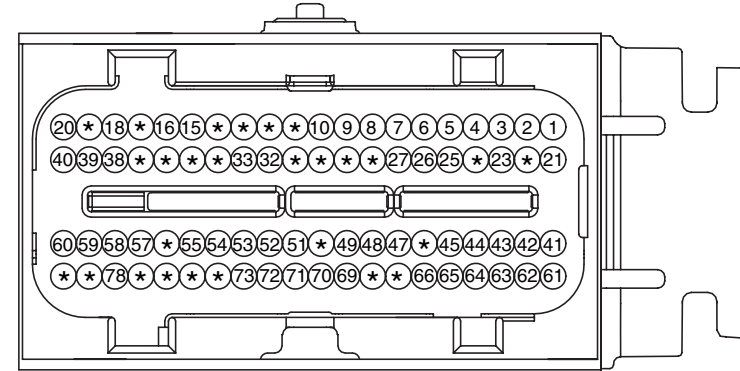

PKD_ECU_80F_Gr_3

C214

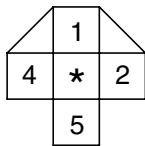

CR05F031

C215

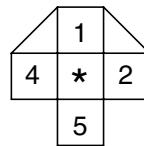

CR05F031

C220

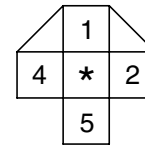

CR05F031

C259

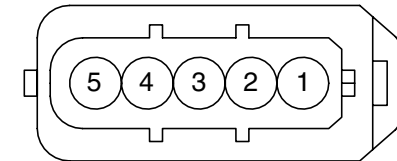

AMP_375_05F_B

E11



PB625_01027

E21

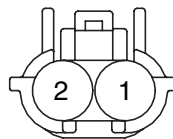

KET_SWP_02F_B

E201



PB625_01027

M04

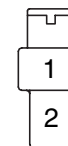

KET_250_02F_W

M12

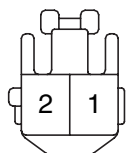

KET_090II_02F_W_L

M15-B

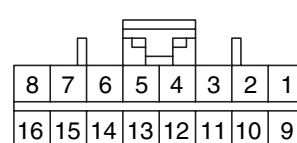

AMP_040M2_16F_B

M26/M26A

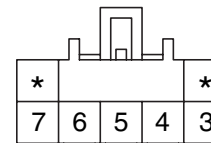

KUM_CDR_07F_B

M28/M28A

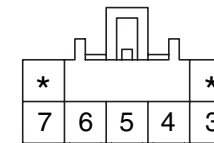

KUM_CDR_07F_W

BLOWER & A/C CONTROLS

BLOWER & A/C CONTROLS (MANUAL) (4)

SD971-10

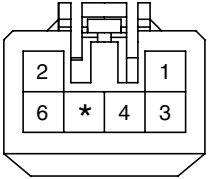
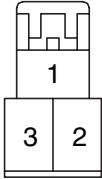
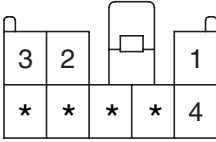
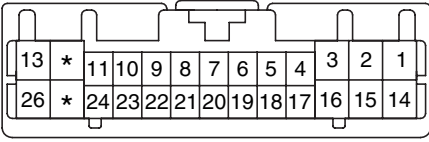
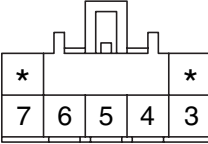
<p style="text-align: center;">M31</p>  <p style="text-align: center;">AMP_090III_06F_L</p>	<p style="text-align: center;">M34</p>  <p style="text-align: center;">KUM_DSD_03F_B</p>	<p style="text-align: center;">M43-A</p>  <p style="text-align: center;">KET_070_08F_W</p>	<p style="text-align: center;">M43-B</p>  <p style="text-align: center;">KET_0407_26F_W</p>
<p style="text-align: center;">M56/M56A</p>  <p style="text-align: center;">KUM_CDR_07F_W</p>	<p>BLANK</p>	<p>BLANK</p>	<p>BLANK</p>

BLOWER & A/C CONTROLS (REAR) (1)

SD971-11

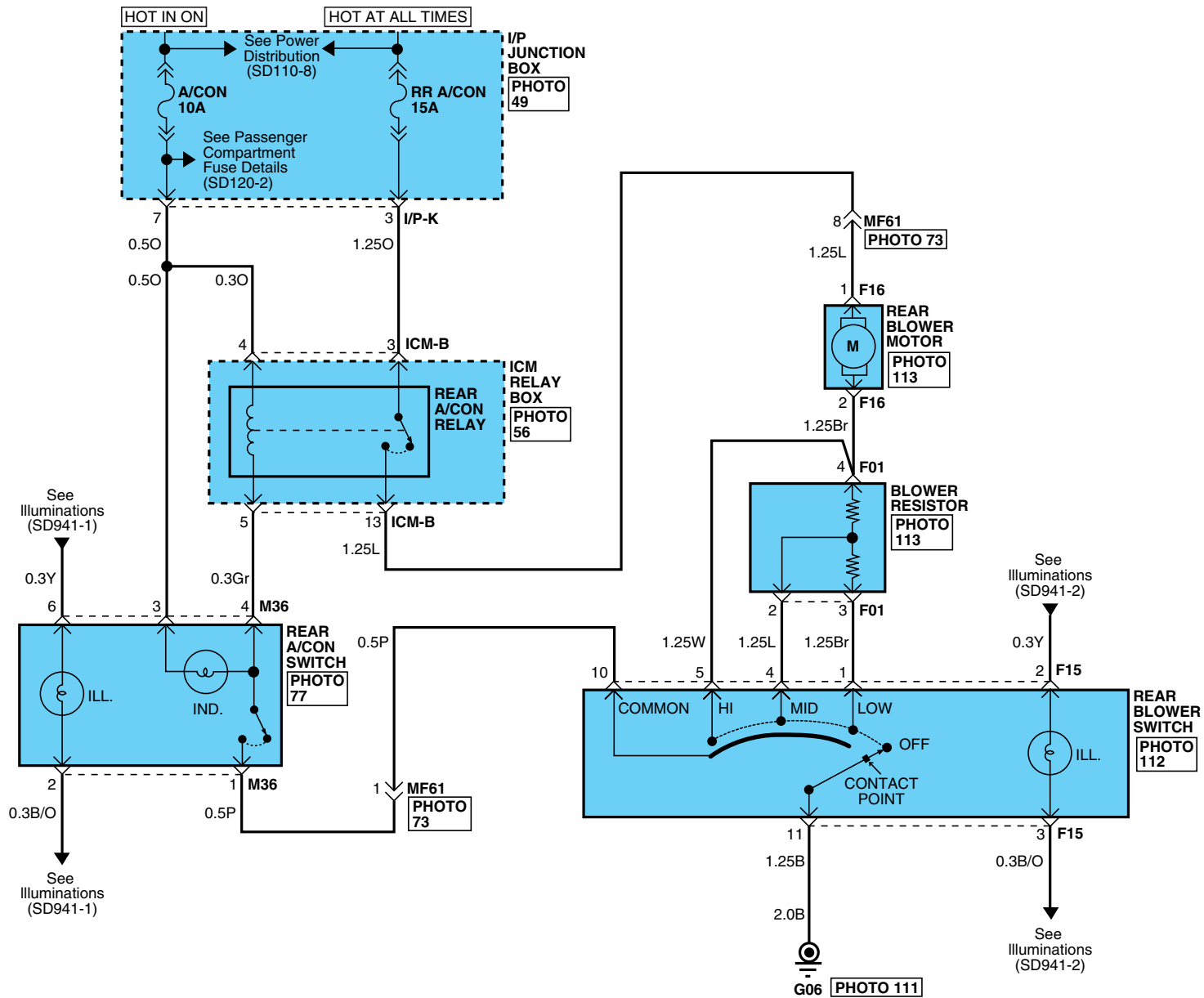

BLOWER & A/C CONTROLS

BLOWER & A/C CONTROLS (REAR) (2)

SD971-12

F01

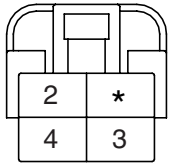

KET_250DL_04F_W

F15

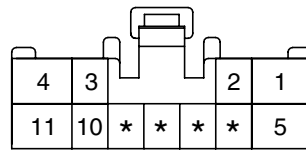

KET_1809_11F_W_HD

F16



KET_250_02F_W

ICM-B

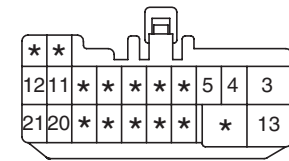

KET_1809_21F_W_A

M36

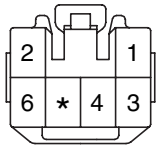

KET_0901I_06F_G

BLANK

BLANK

BLANK

FRONT WIPER & WASHER

FRONT WIPER & WASHER (3)

SD981-3

C217



AMP_MCPE_06F_B

C271



KET_090IWP_03F_Gr

M13-C

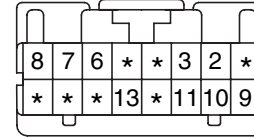

KET_0407_16F_W

M13-D

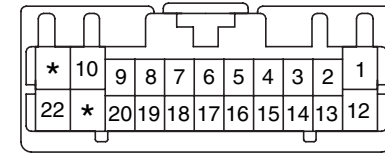

KET_0407_22F_W

M20-1/M20-1A

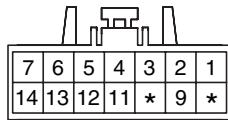

KET_090II_14F_B

R35

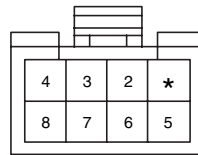

MLX_118_08F_B

BLANK

BLANK

FRONT WIPER & WASHER

FRONT WIPER & WASHER (4)

SD981-4

MEMO

REAR WIPER & WASHER

REAR WIPER & WASHER (2)

SD982-2

C271



KET_090IWP_03F_Gr

F32

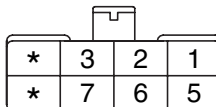

KET_250_08F_B

M20-1/M20-1A

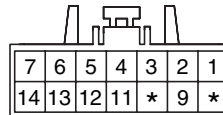

KET_090II_14F_B

R11

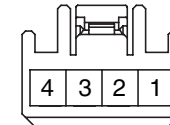

AMP_090III_04F_W

COMPONENT LOCATIONS(1)

CL-1

PHOTO.1

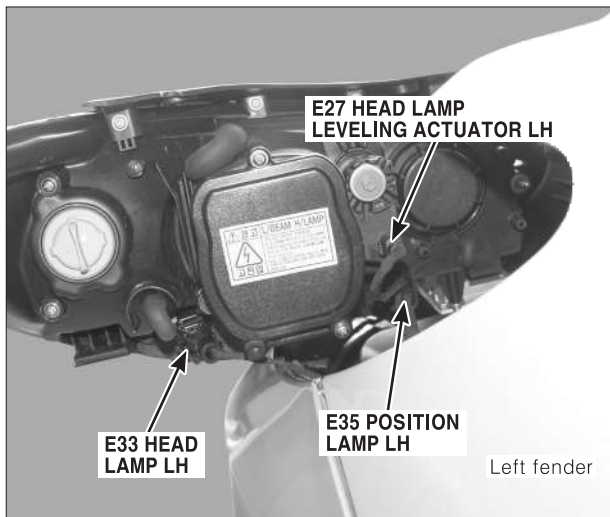

PHOTO.2



PHOTO.3

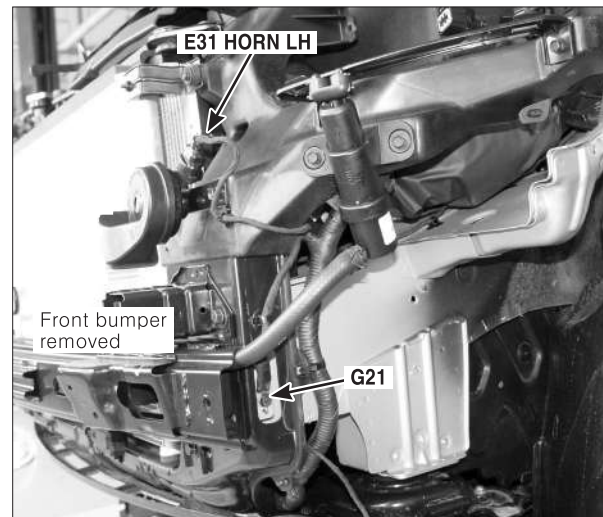

PHOTO.4

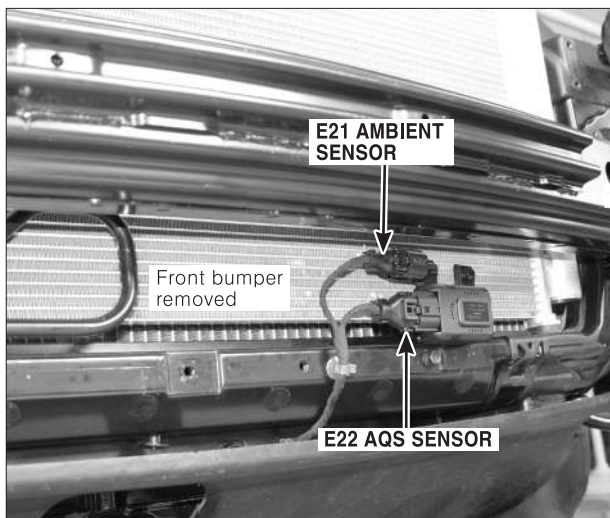

PHOTO.5

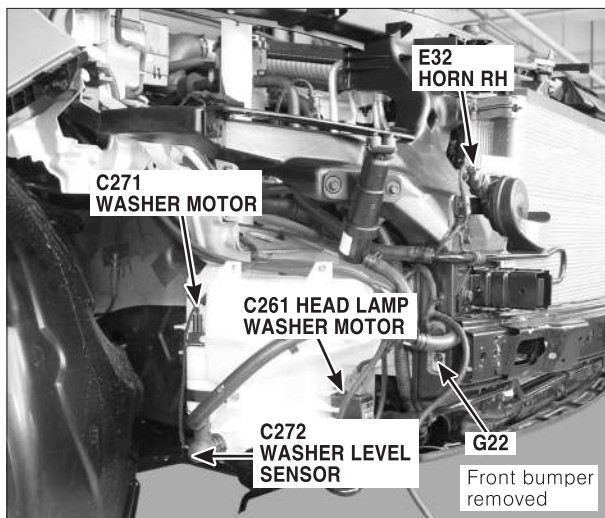
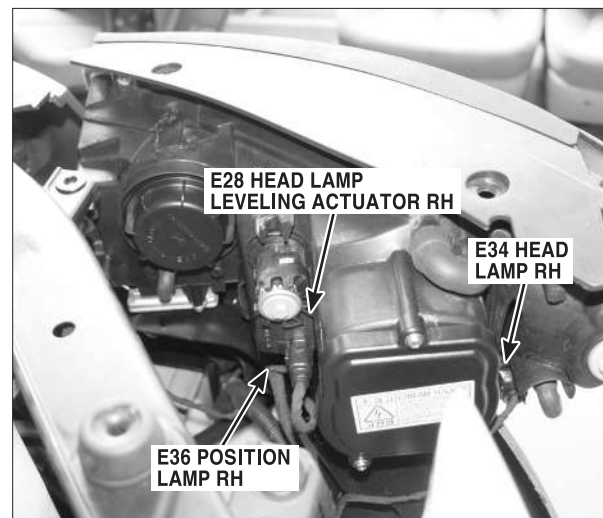

PHOTO.6



COMPONENT LOCATIONS

COMPONENT LOCATIONS(2)

CL-2

PHOTO.7

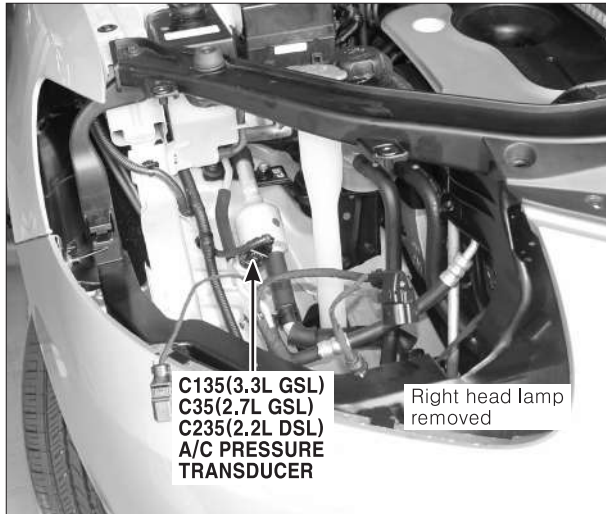

PHOTO.8

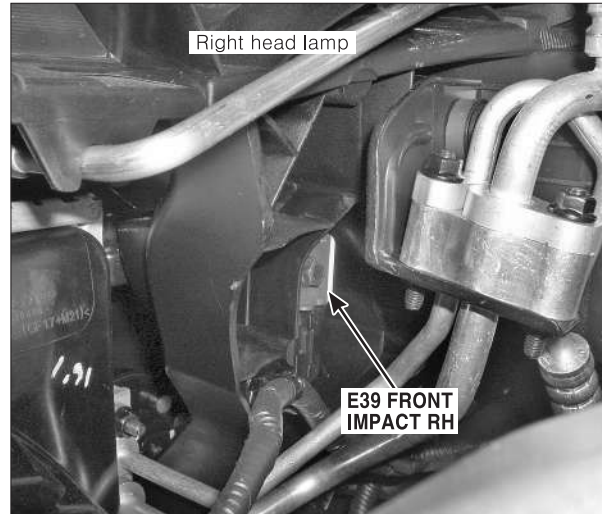

PHOTO.9

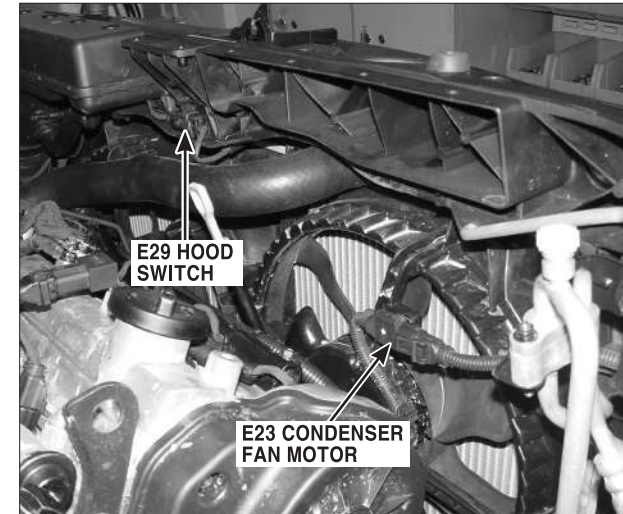

PHOTO.10

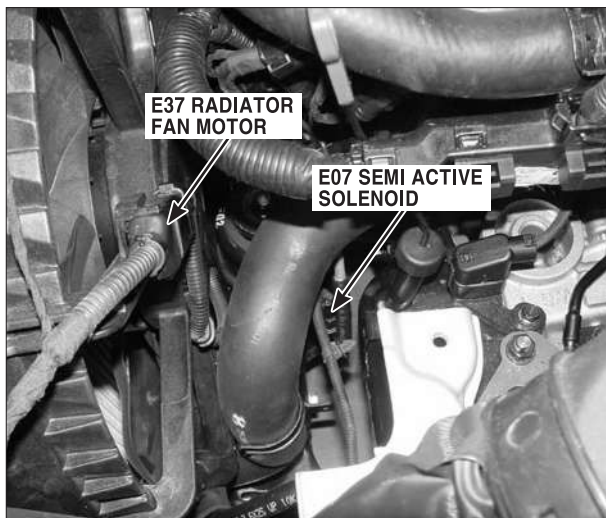
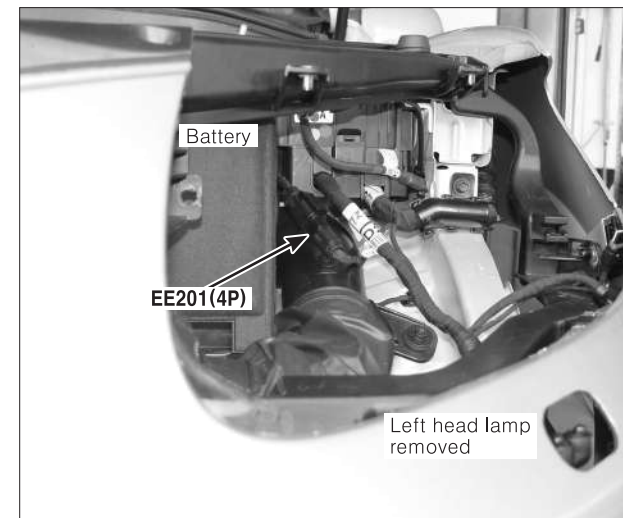

PHOTO.11



PHOTO.12



COMPONENT LOCATIONS

COMPONENT LOCATIONS(3)

CL-3

PHOTO.13

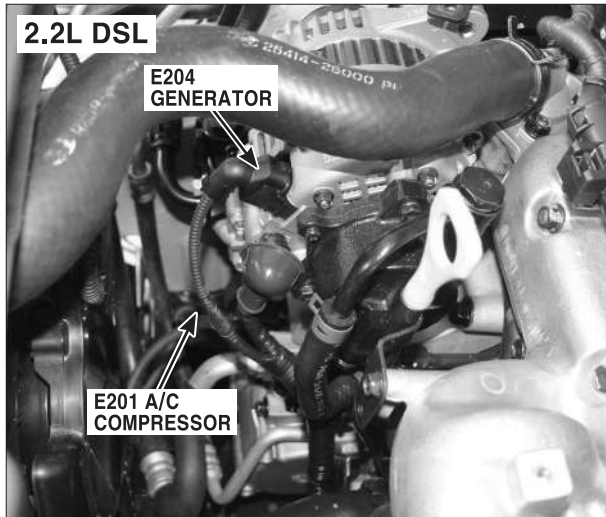

PHOTO.14

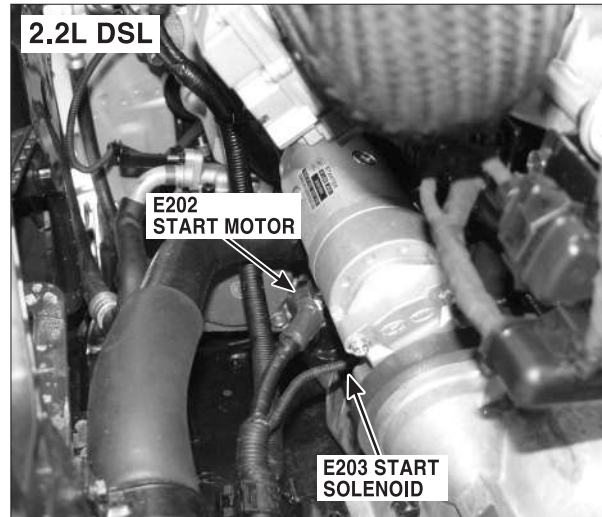

PHOTO.15

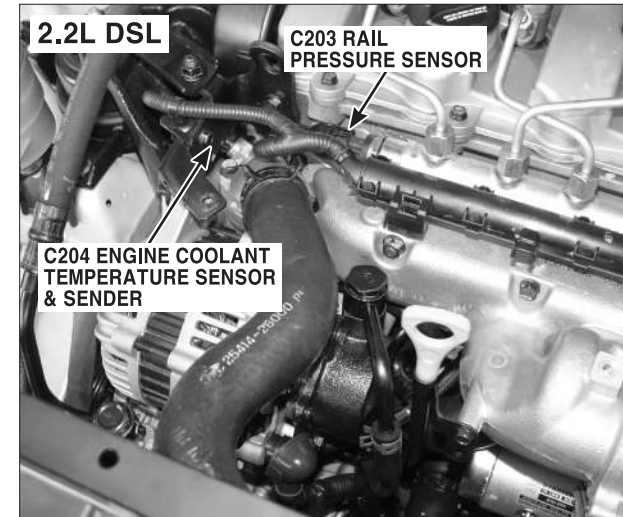

PHOTO.16

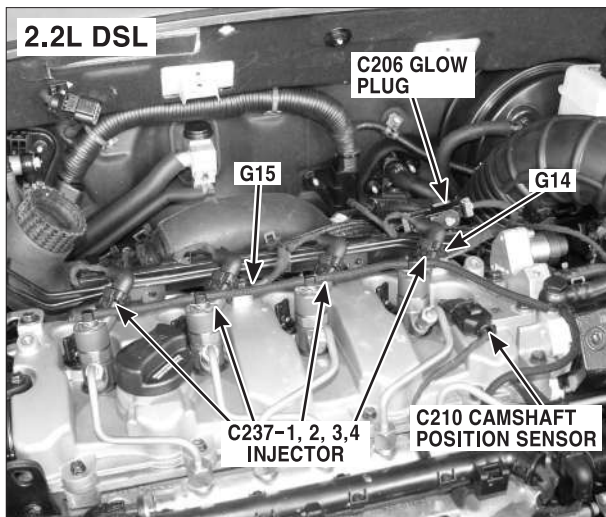

PHOTO.17

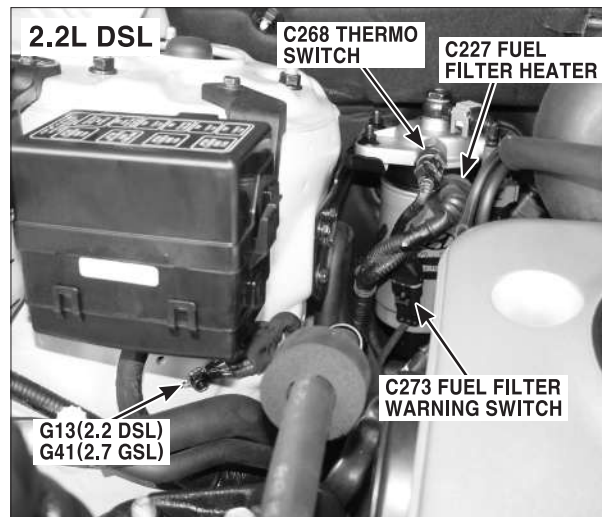
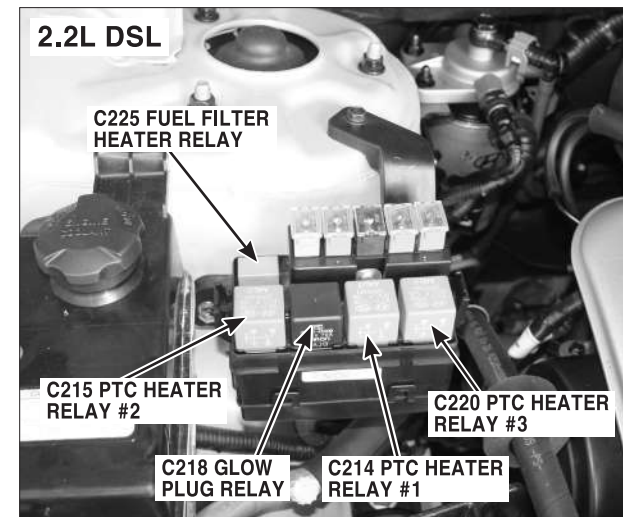

PHOTO.18



COMPONENT LOCATIONS

COMPONENT LOCATIONS(4)

CL-4

PHOTO.19

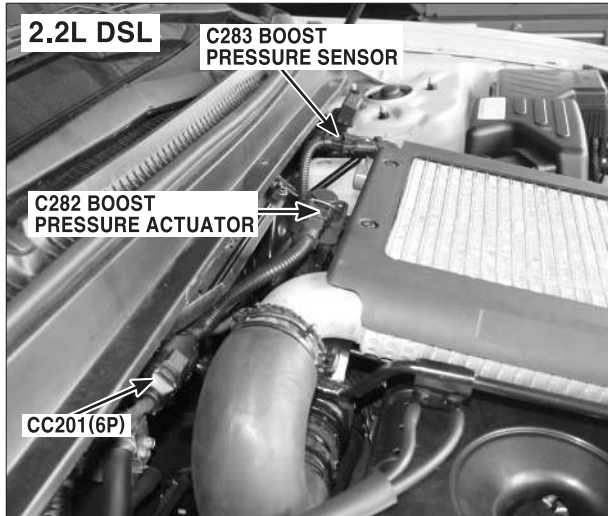

PHOTO.20

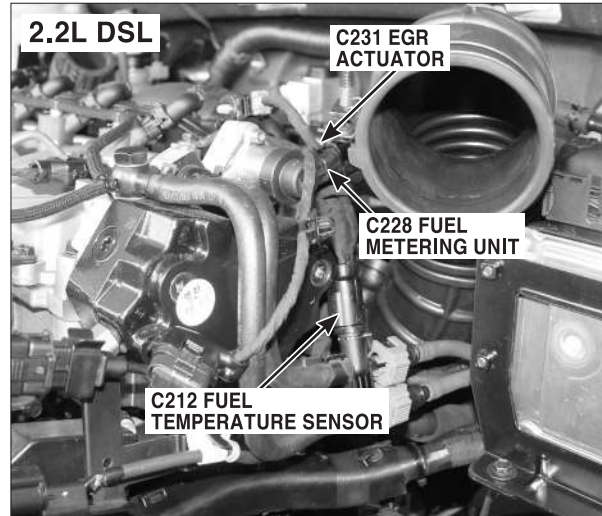

PHOTO.21



PHOTO.22

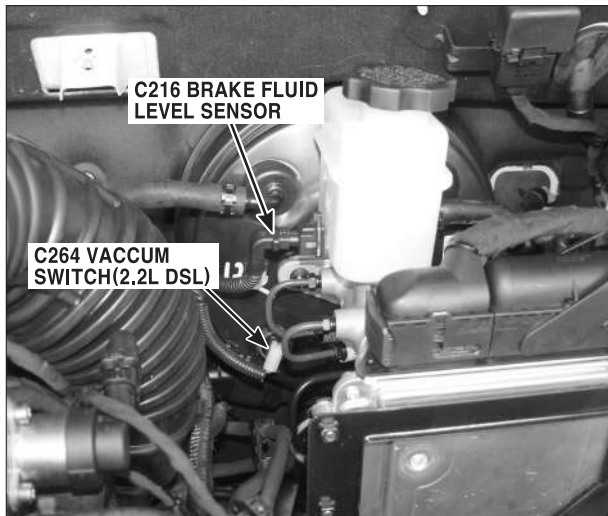

PHOTO.23

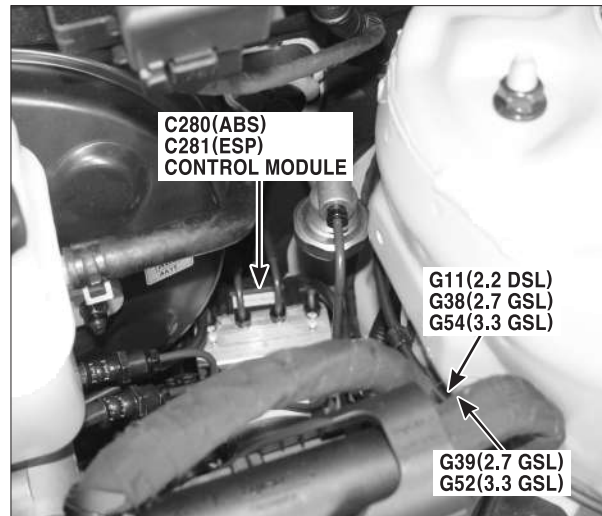
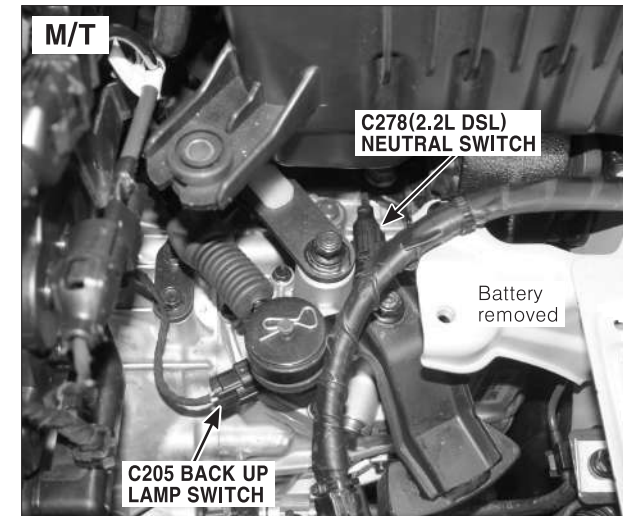

PHOTO.24



COMPONENT LOCATIONS

COMPONENT LOCATIONS(5)

CL-5

PHOTO.25

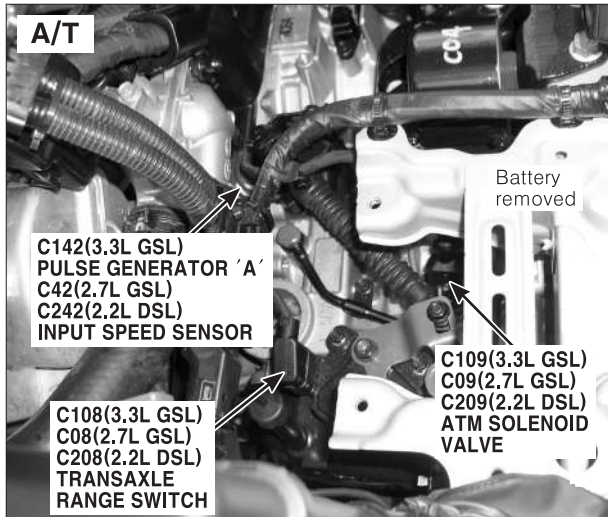

PHOTO.26

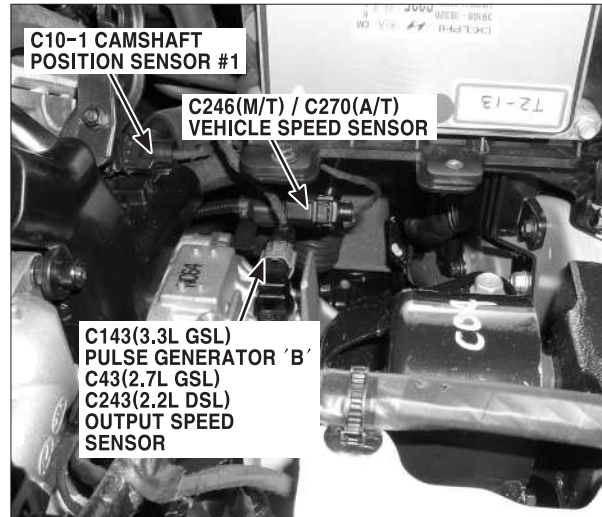

PHOTO.27

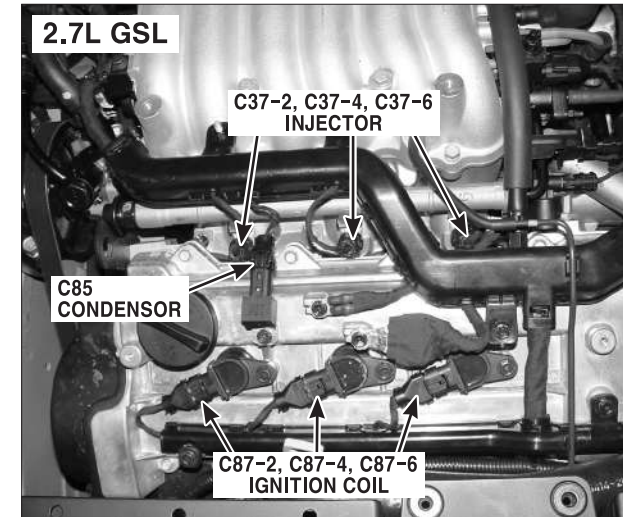

PHOTO.28

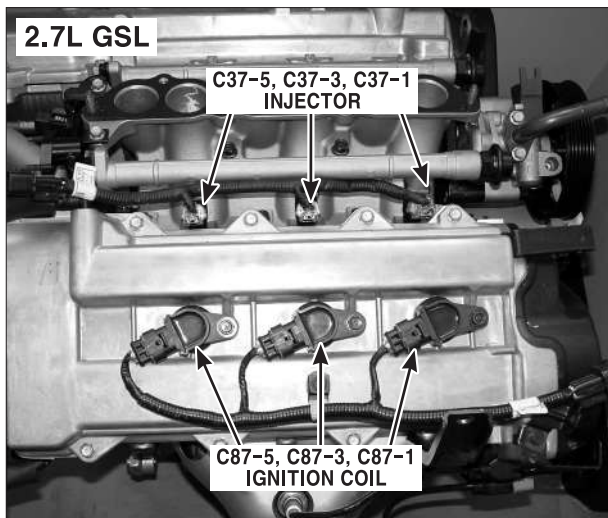

PHOTO.29

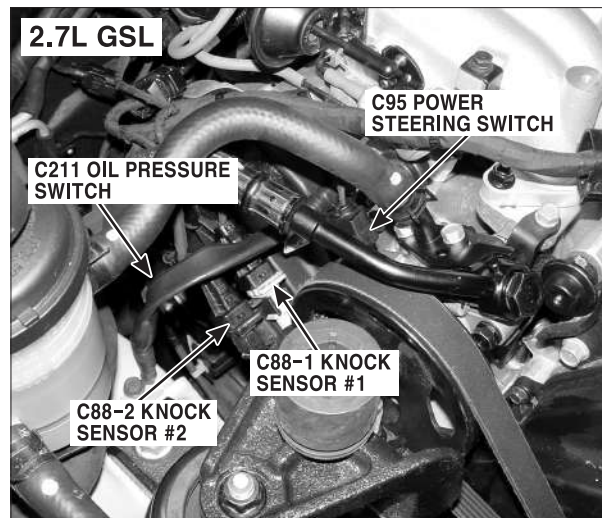
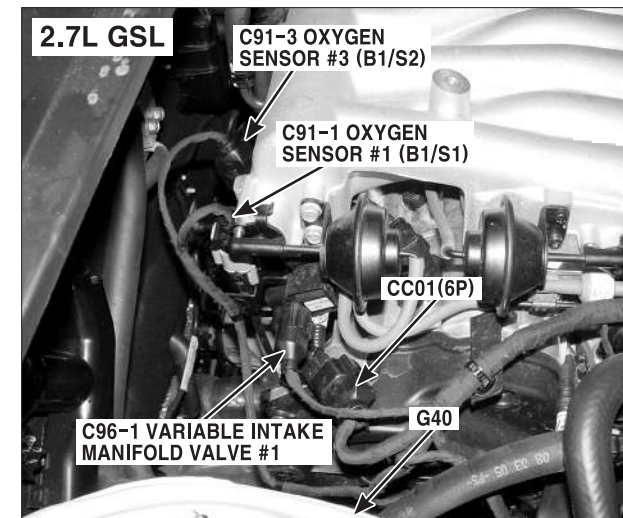

PHOTO.30



COMPONENT LOCATIONS

COMPONENT LOCATIONS(6)

CL-6

PHOTO.31

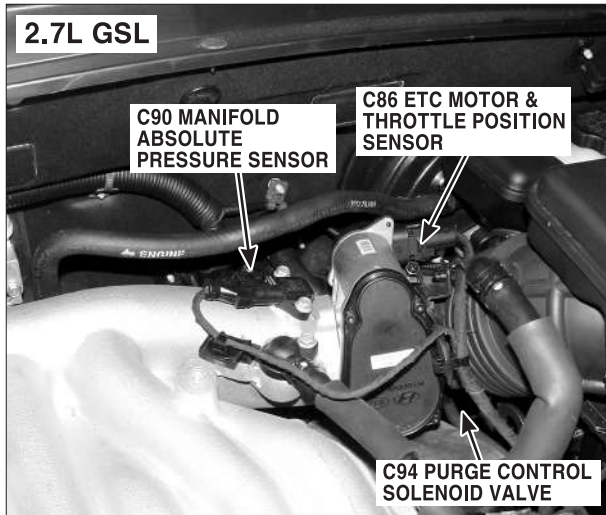

PHOTO.32

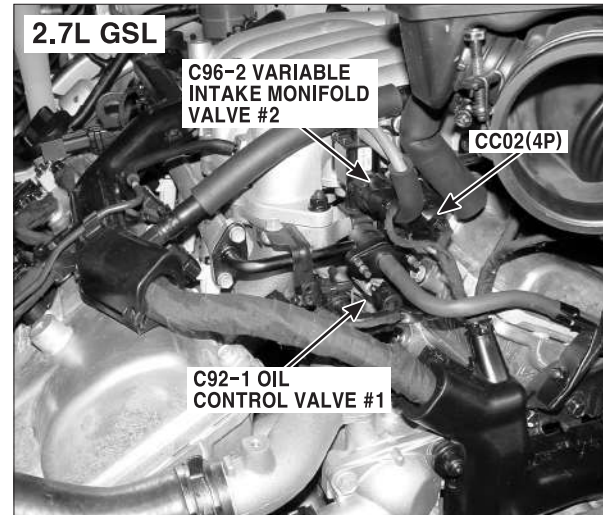

PHOTO.33

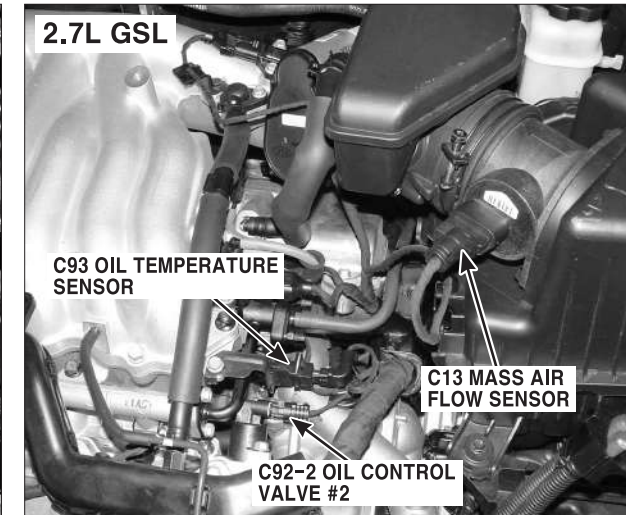

PHOTO.34

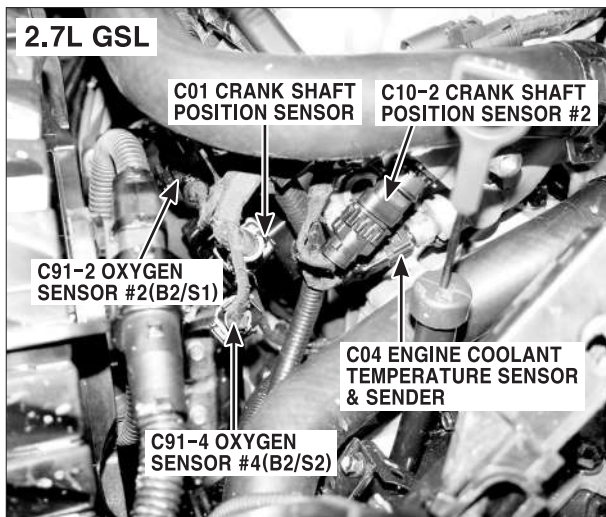

PHOTO.35

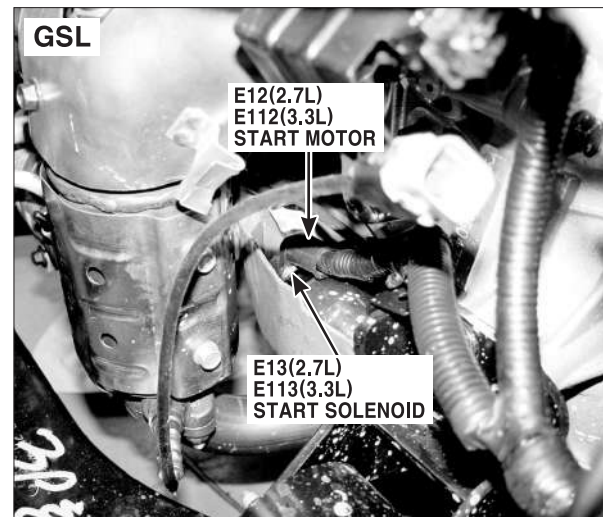
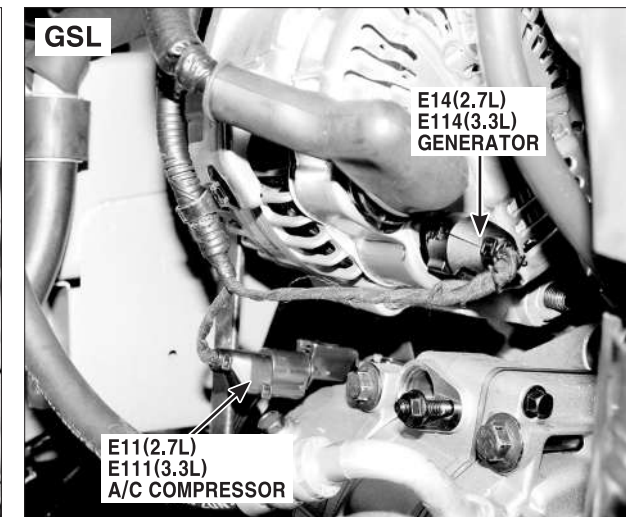

PHOTO.36



COMPONENT LOCATIONS

COMPONENT LOCATIONS(7)

CL-7

PHOTO.37



PHOTO.38

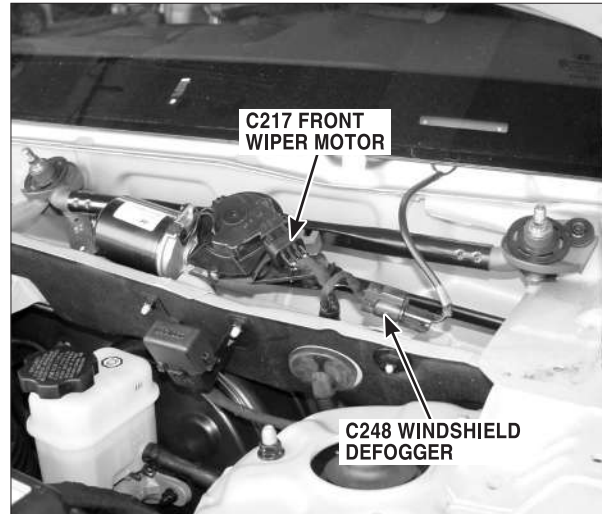

PHOTO.39

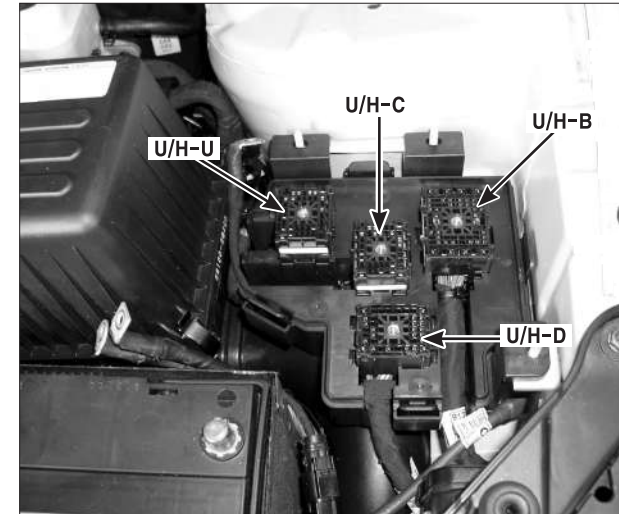

PHOTO.40



PHOTO.41

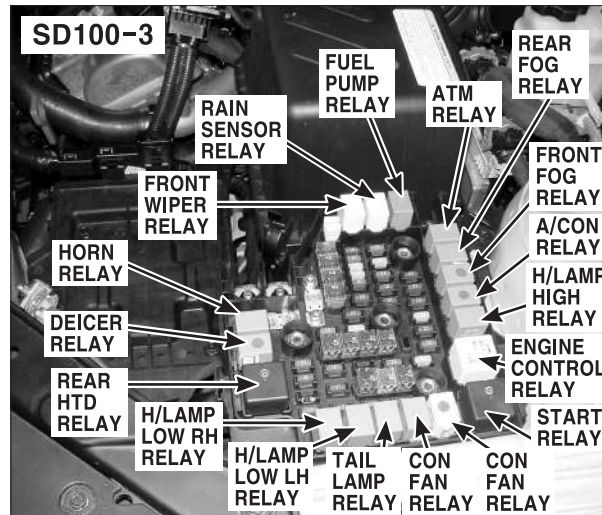
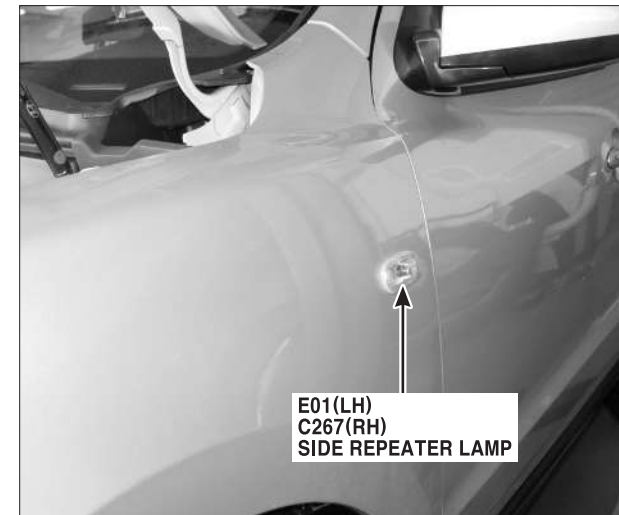

PHOTO.42



COMPONENT LOCATIONS

COMPONENT LOCATIONS(8)

CL-8

PHOTO.43

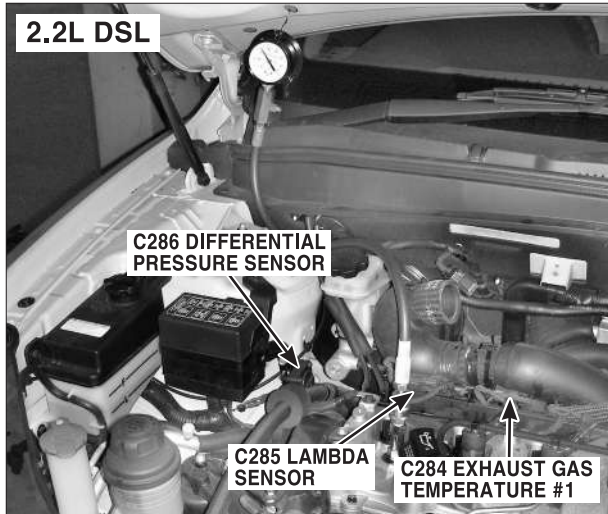

PHOTO.44

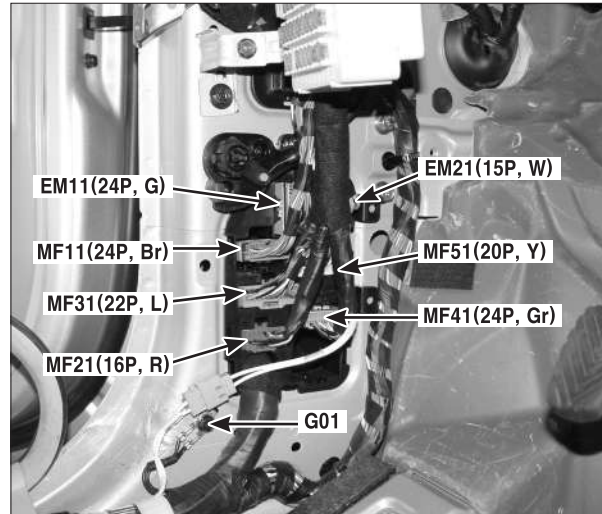

PHOTO.45

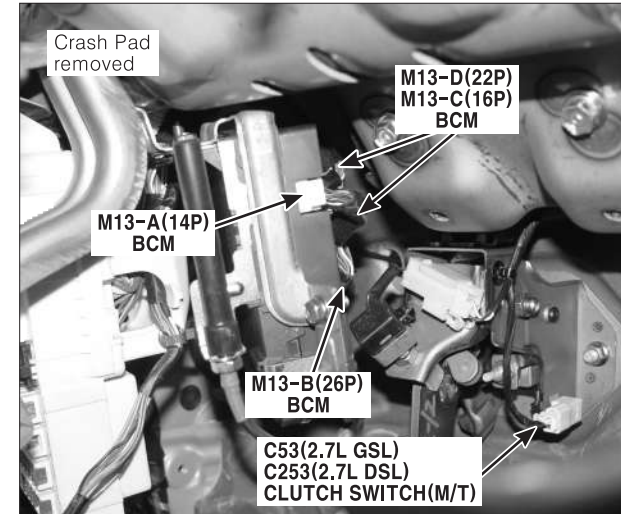

PHOTO.46

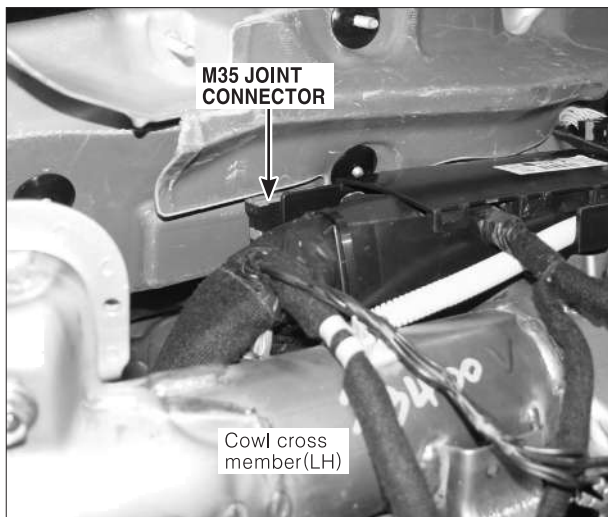

PHOTO.47

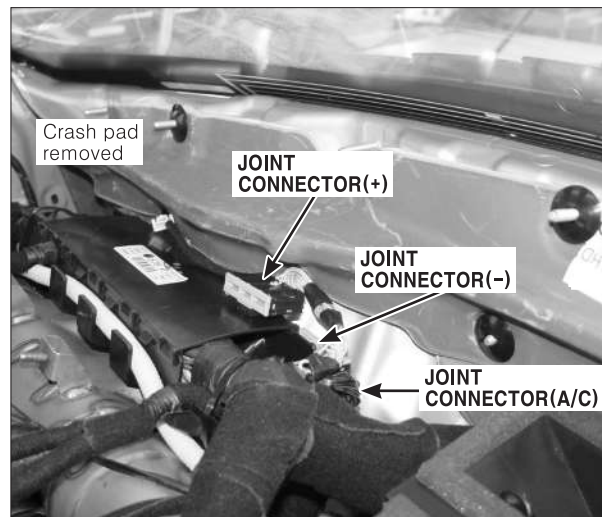
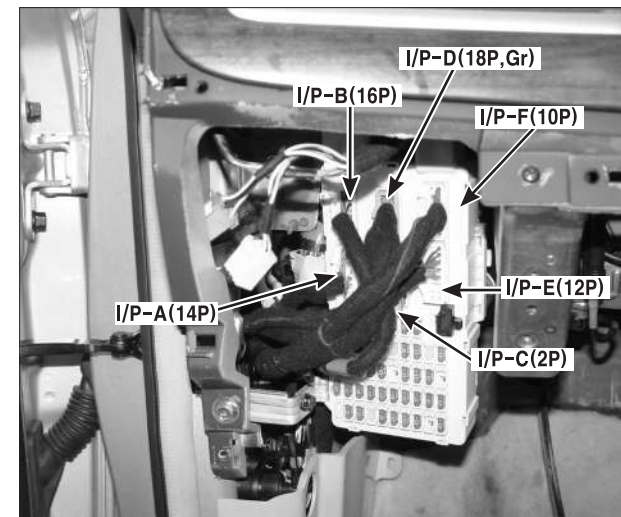

PHOTO.48



COMPONENT LOCATIONS

COMPONENT LOCATIONS(9)

CL-9

PHOTO.49

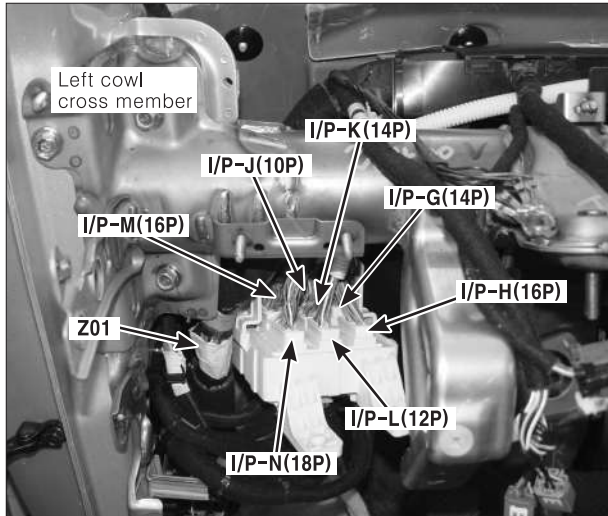

PHOTO.50

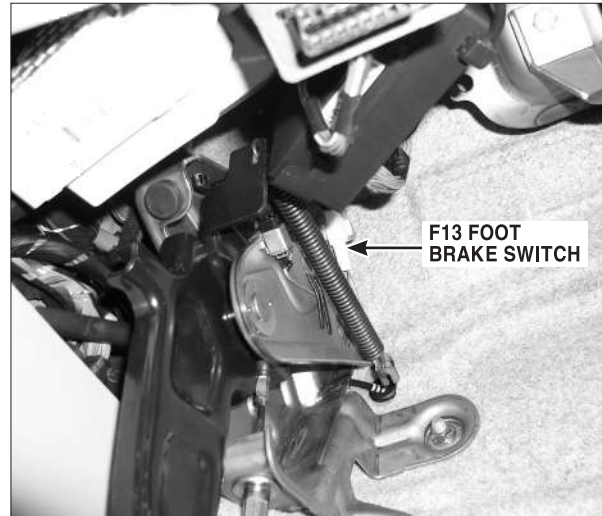

PHOTO.51

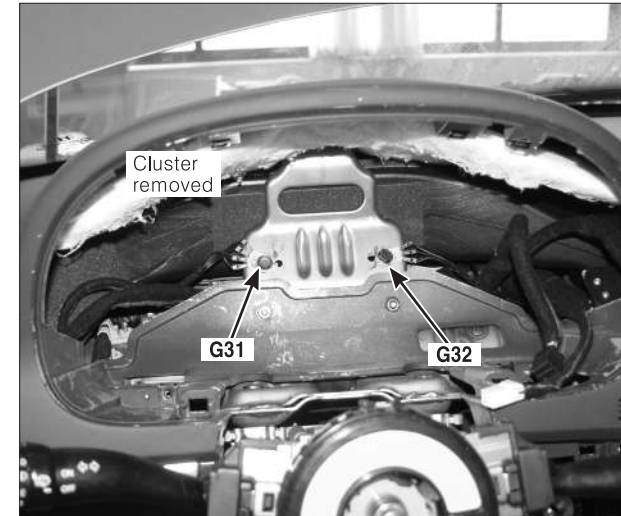

PHOTO.52

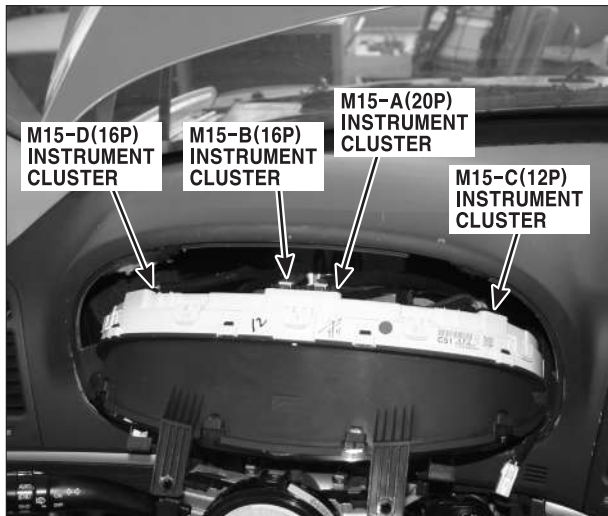

PHOTO.53

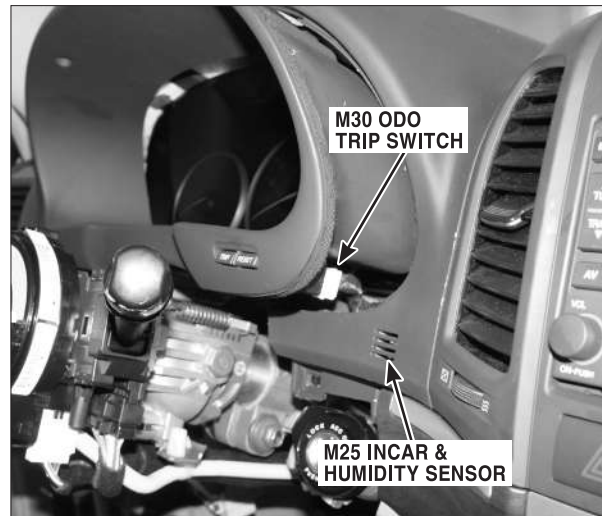
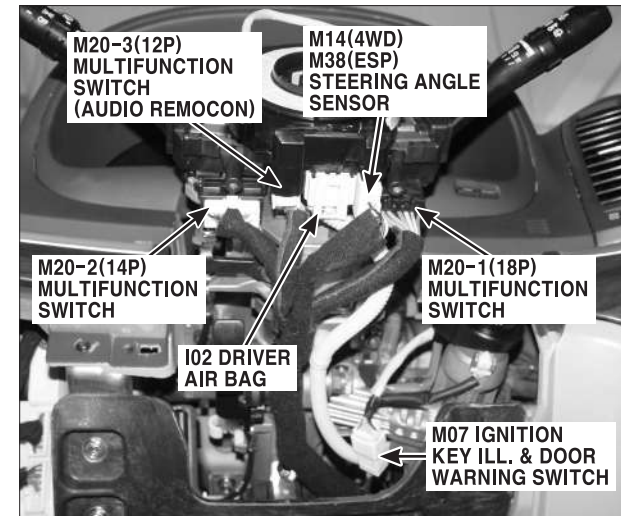

PHOTO.54



COMPONENT LOCATIONS

COMPONENT LOCATIONS(10)

CL-10

PHOTO.55

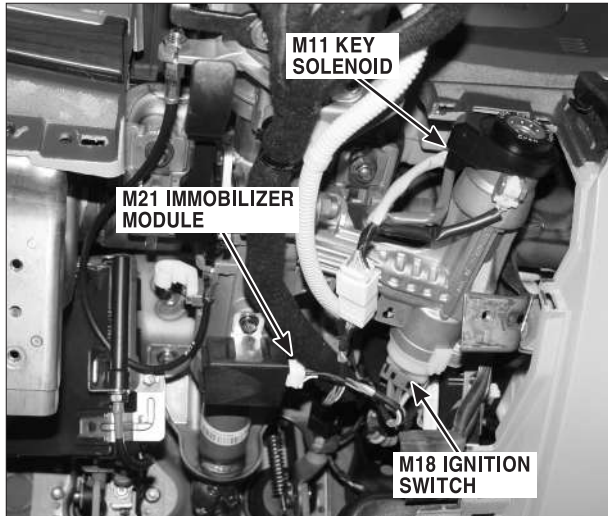

PHOTO.56

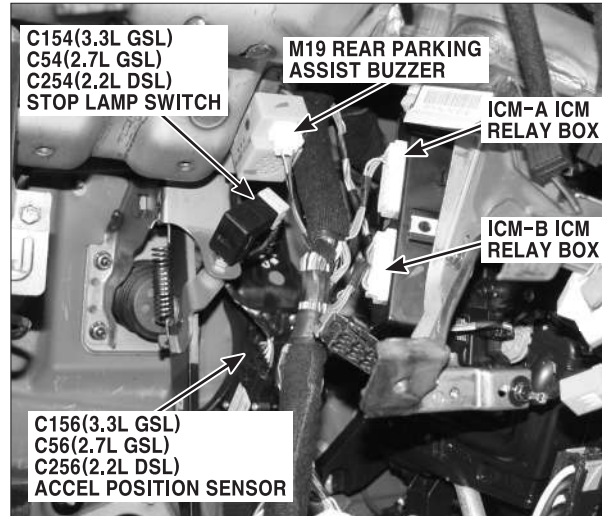

PHOTO.57

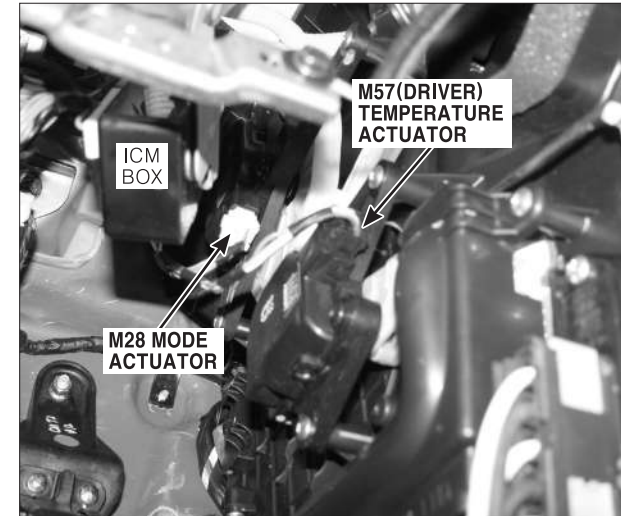

PHOTO.58

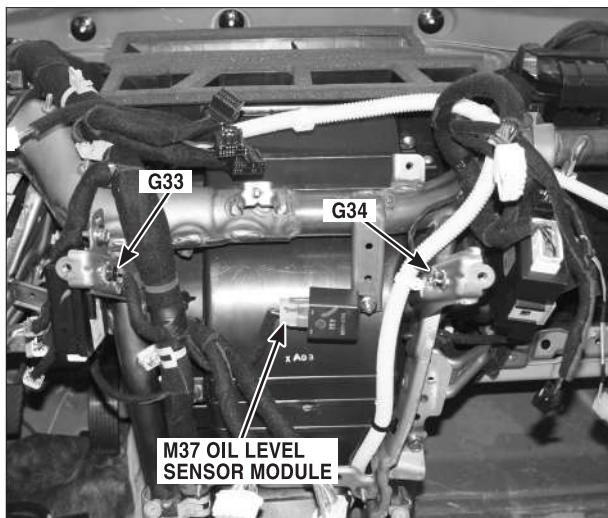

PHOTO.59

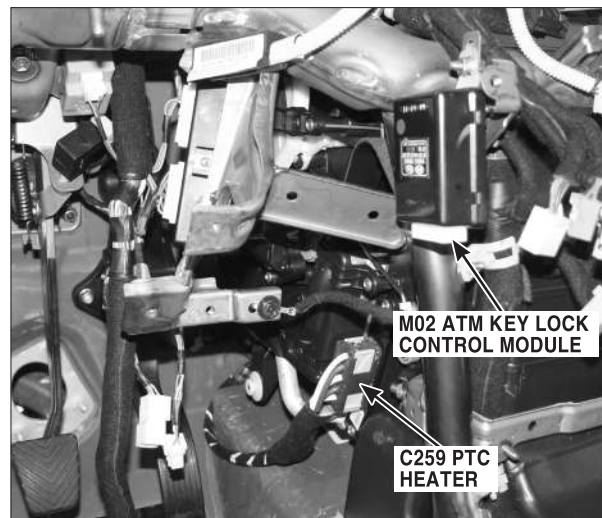
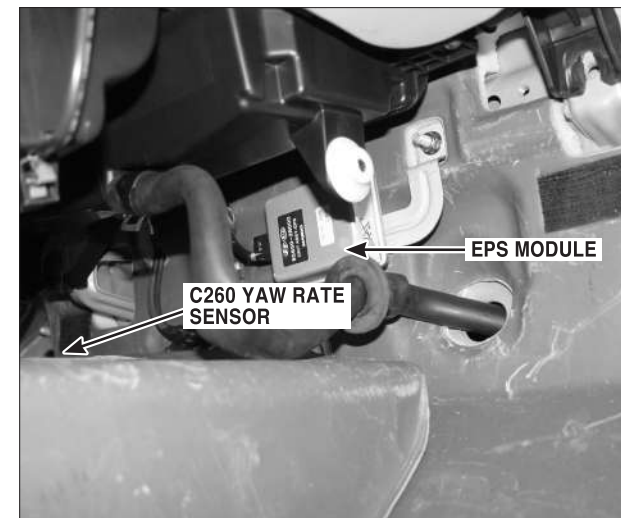

PHOTO.60



COMPONENT LOCATIONS

COMPONENT LOCATIONS(11)

CL-11

PHOTO.61

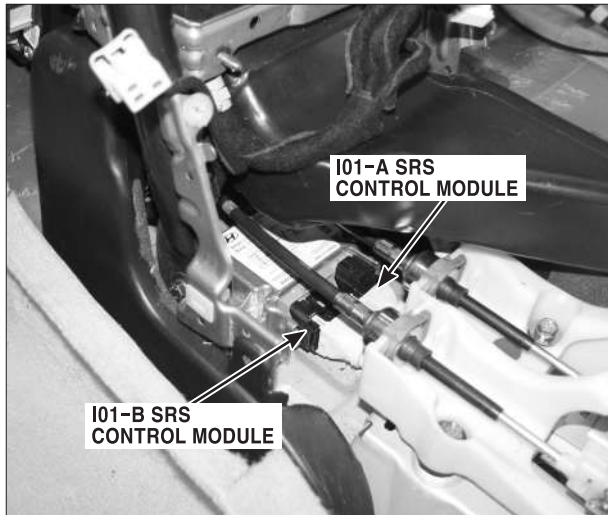

PHOTO.62



PHOTO.63



PHOTO.64

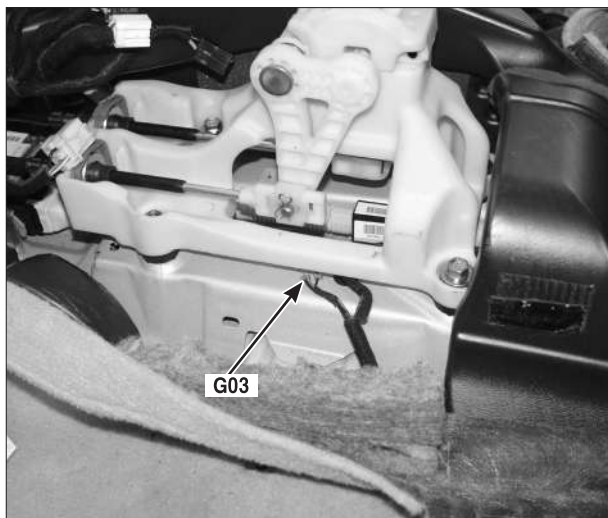

PHOTO.65

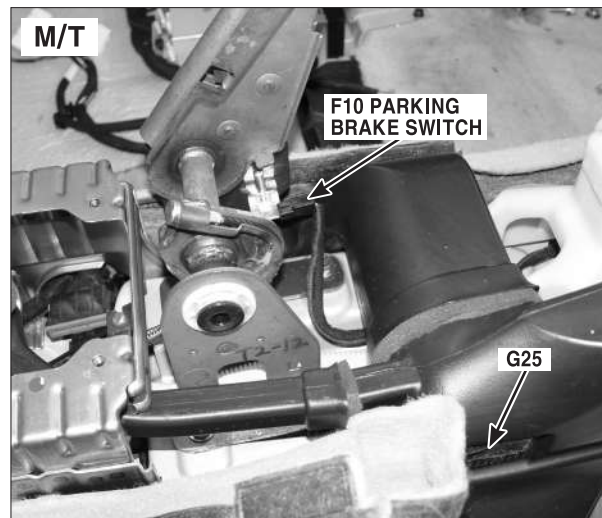
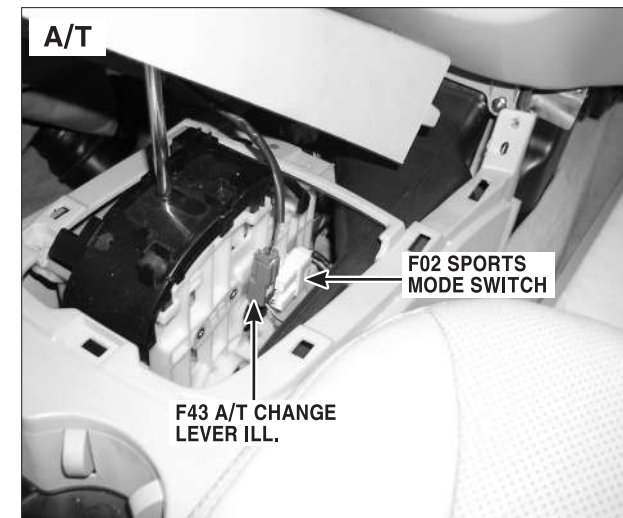

PHOTO.66



COMPONENT LOCATIONS

COMPONENT LOCATIONS(12)

CL-12

PHOTO.67

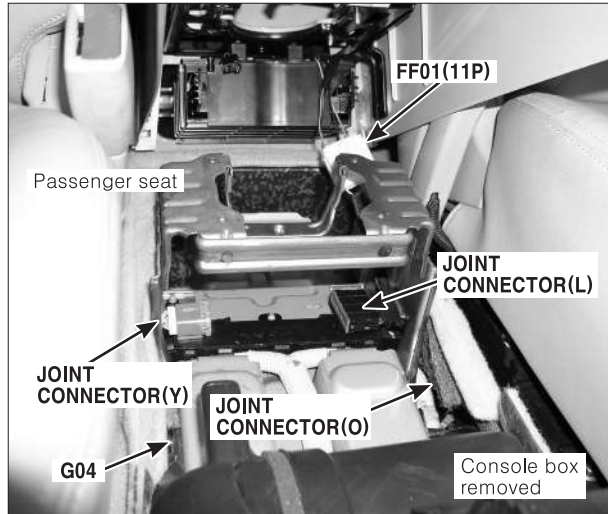

PHOTO.68



PHOTO.69

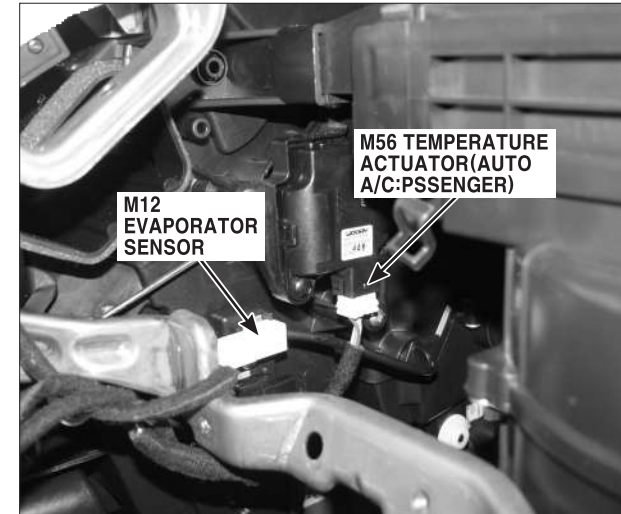

PHOTO.70

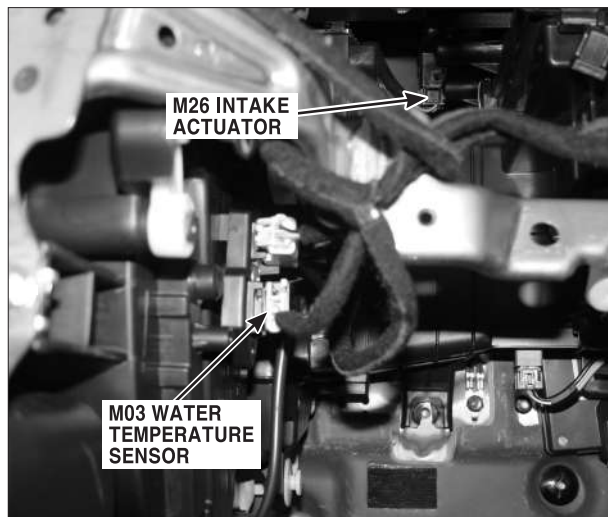

PHOTO.71

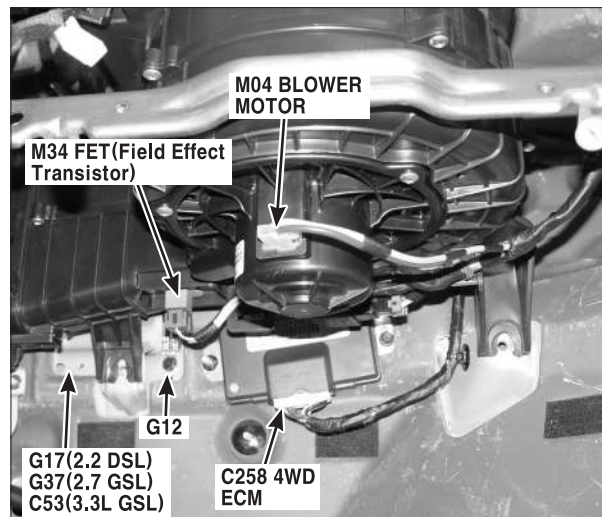
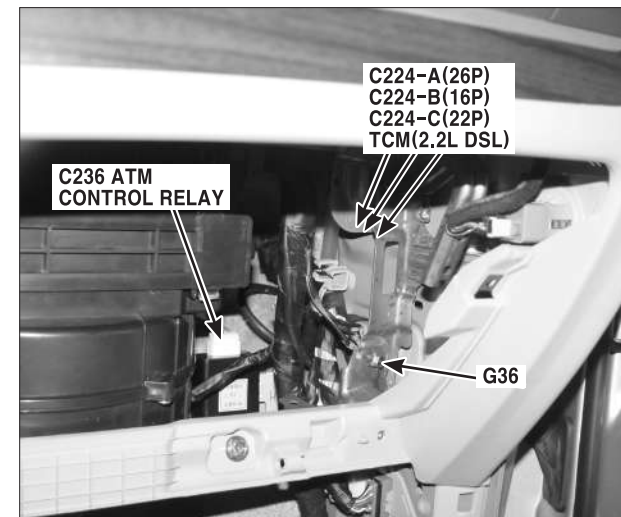

PHOTO.72



COMPONENT LOCATIONS

COMPONENT LOCATIONS(13)

CL-13

PHOTO.73

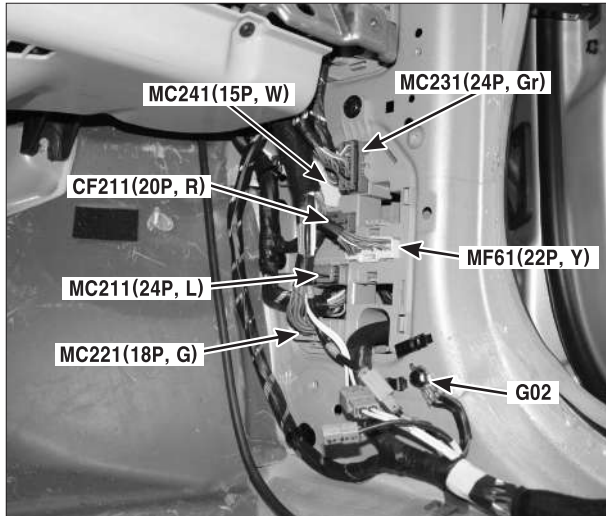

PHOTO.74

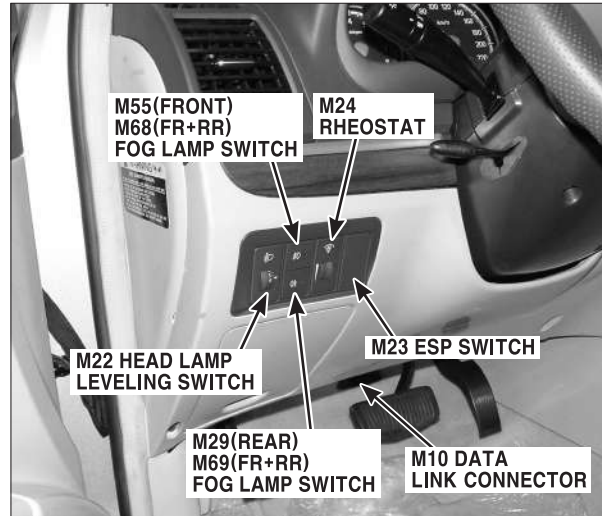

PHOTO.75

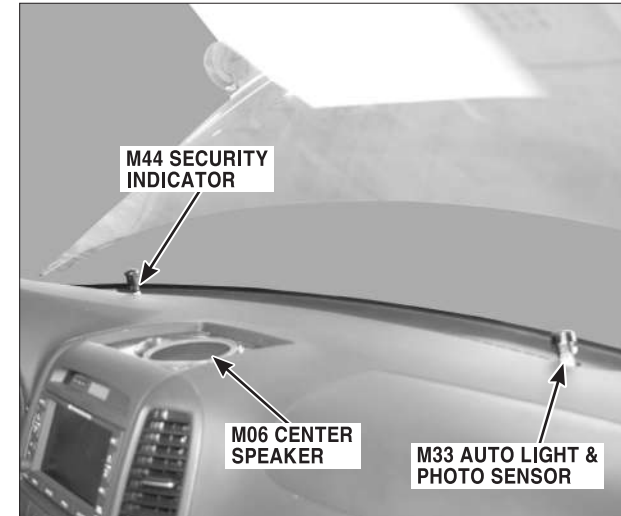

PHOTO.76

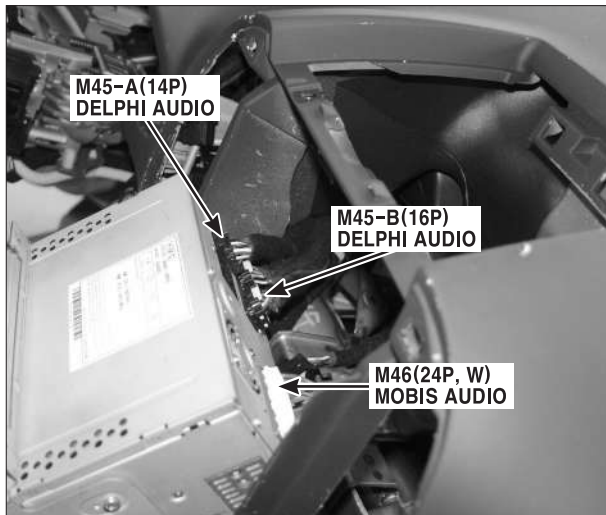

PHOTO.77

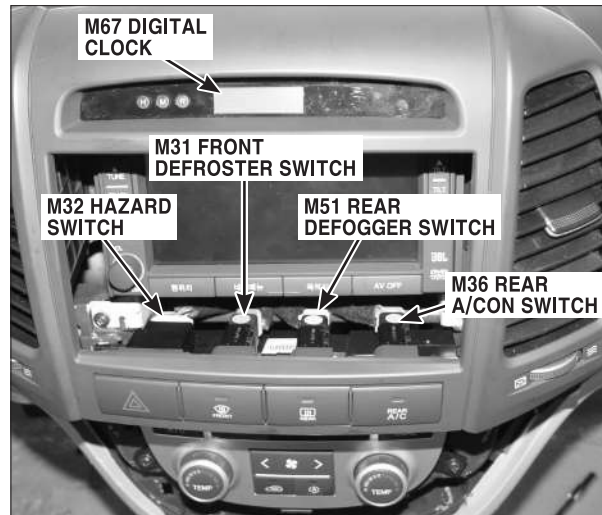
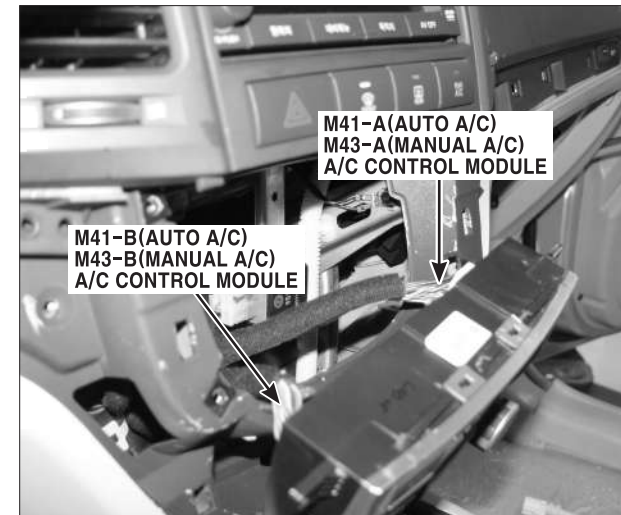

PHOTO.78



COMPONENT LOCATIONS

COMPONENT LOCATIONS(14)

CL-14

PHOTO.79



PHOTO.80

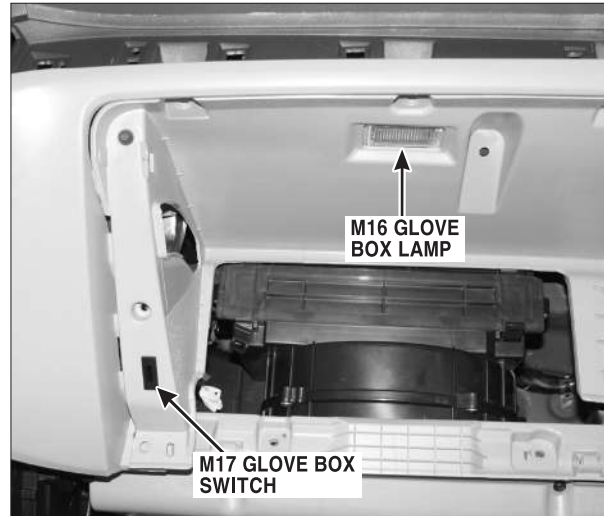

PHOTO.81



PHOTO.82

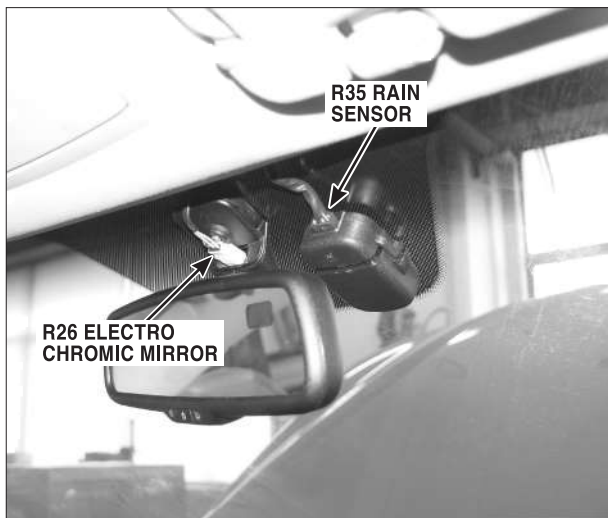
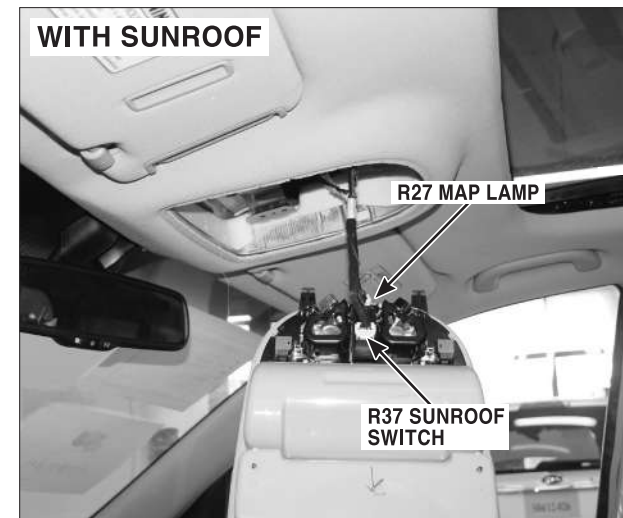

PHOTO.83



PHOTO.84



COMPONENT LOCATIONS

COMPONENT LOCATIONS(15)

CL-15

PHOTO.85

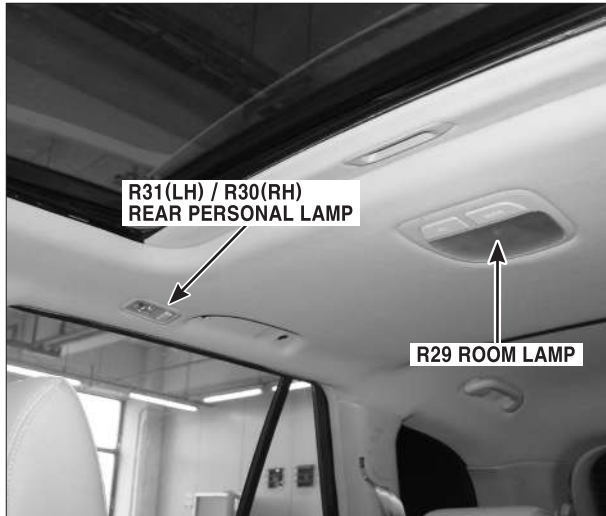

PHOTO.86

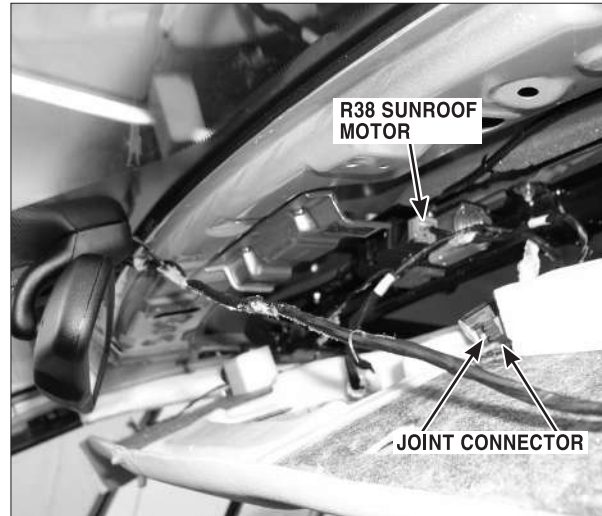

PHOTO.87



PHOTO.88

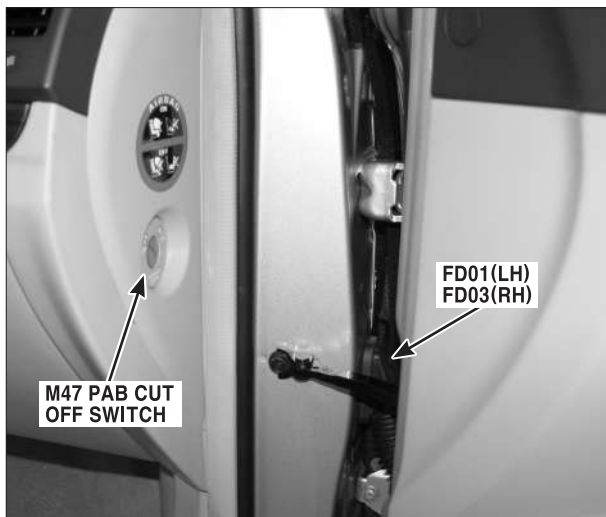

PHOTO.89

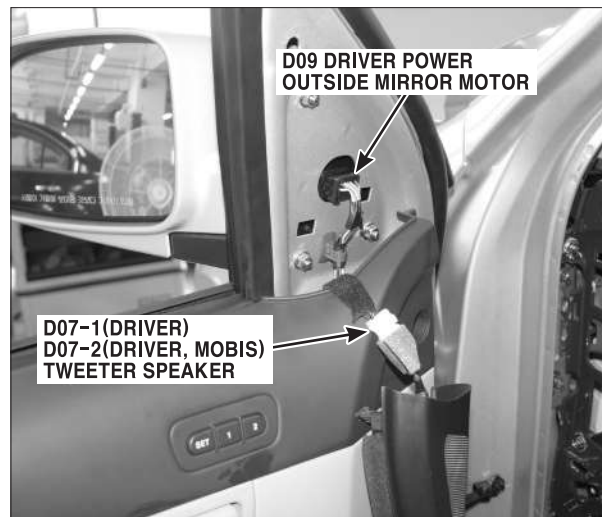
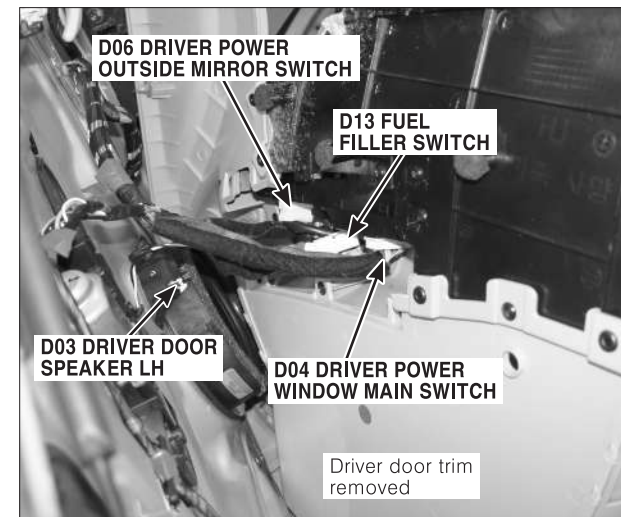

PHOTO.90



COMPONENT LOCATIONS

COMPONENT LOCATIONS(16)

CL-16

PHOTO.91

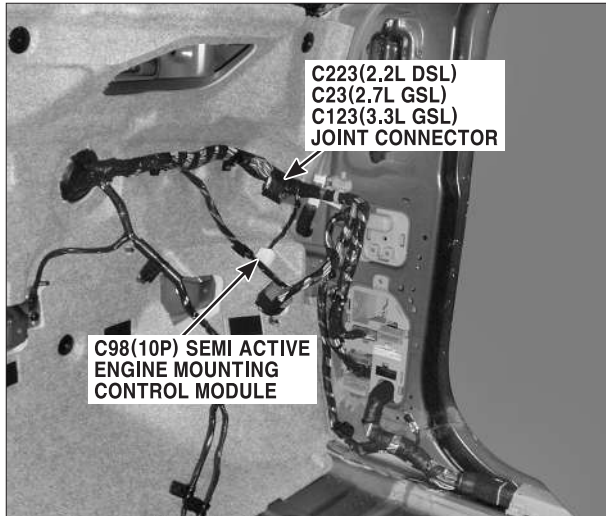

PHOTO.92

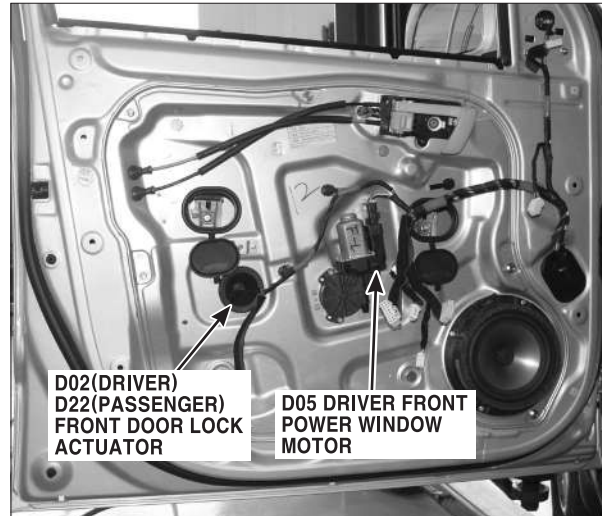

PHOTO.93

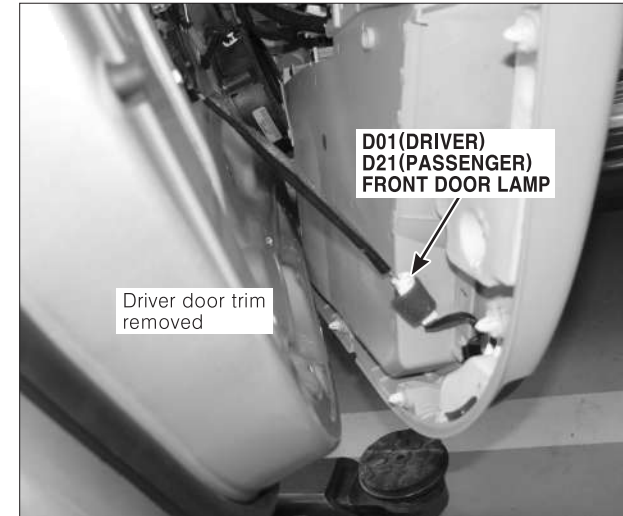

PHOTO.94

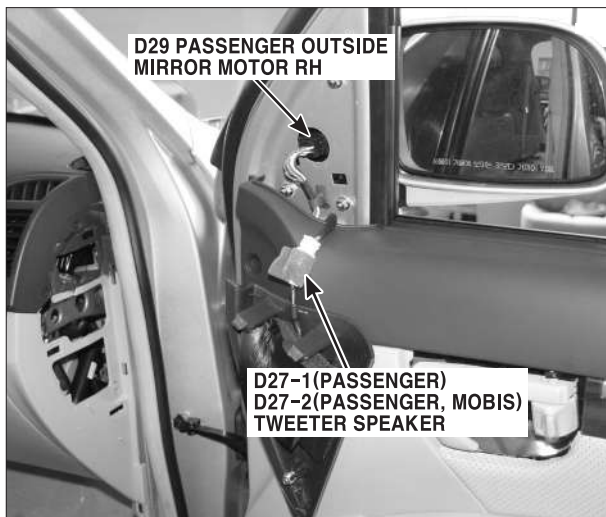

PHOTO.95

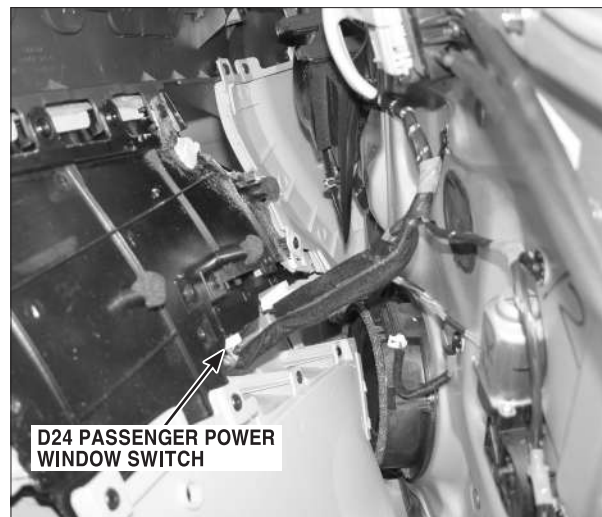
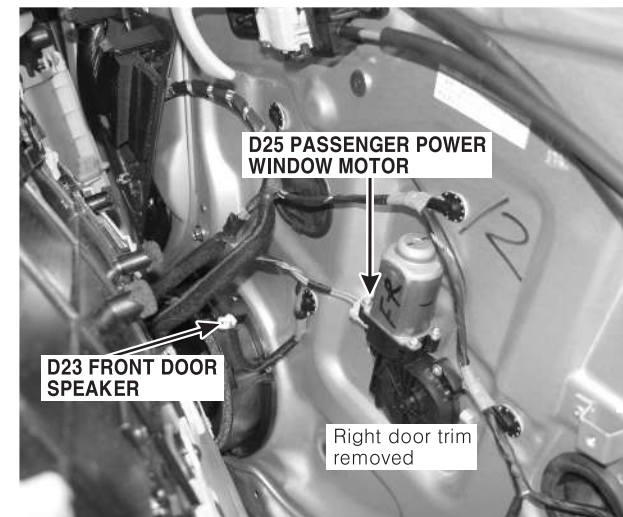

PHOTO.96



COMPONENT LOCATIONS

COMPONENT LOCATIONS(17)

CL-17

PHOTO.97

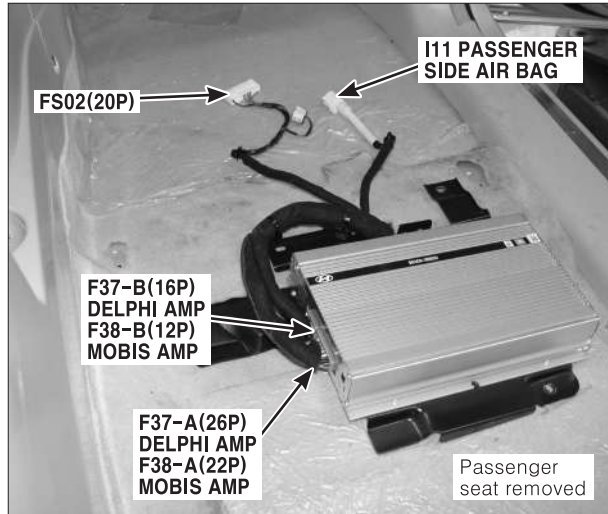

PHOTO.98

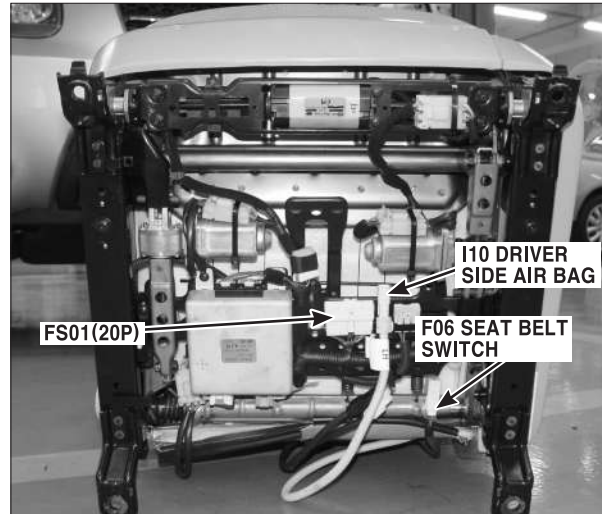

PHOTO.99

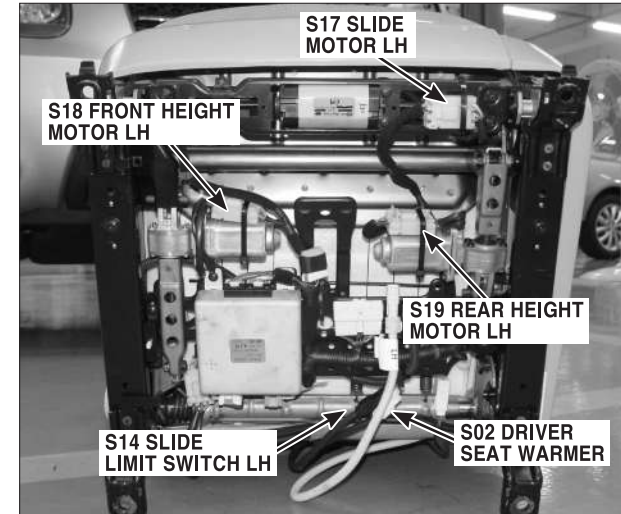

PHOTO.100

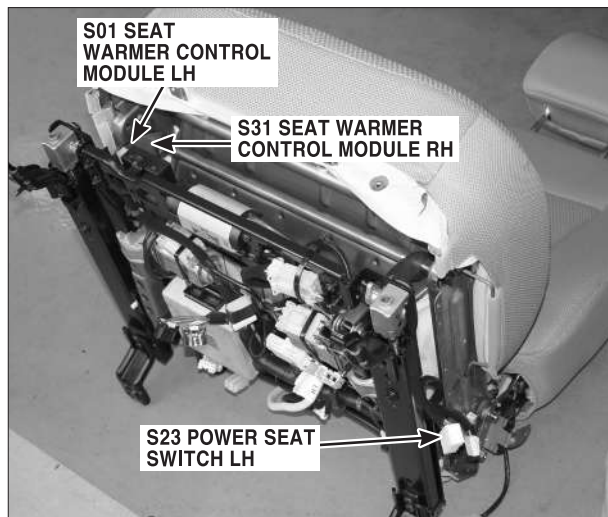

PHOTO.101

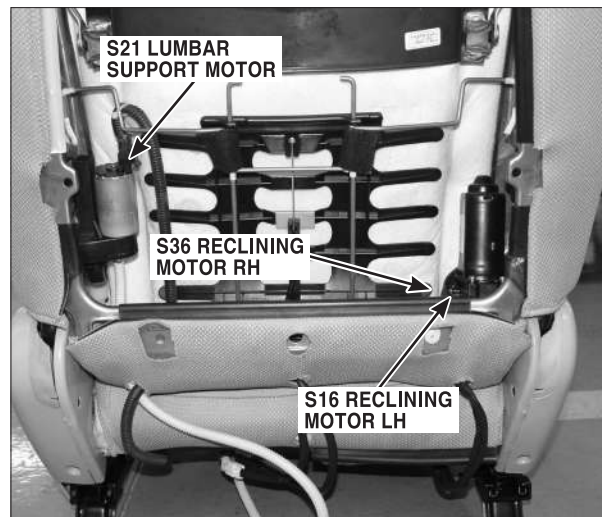
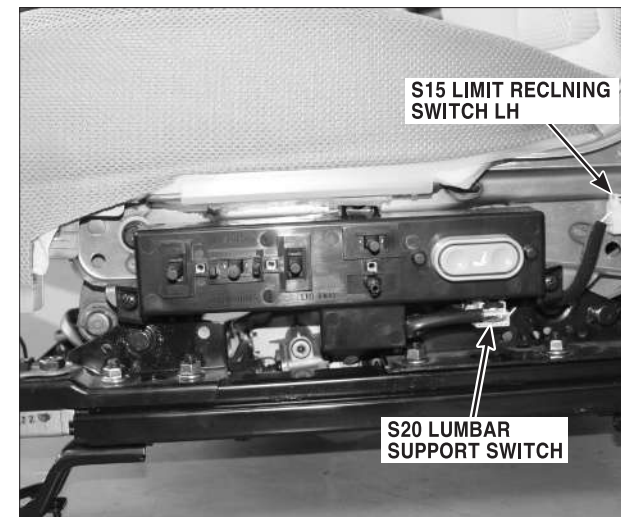

PHOTO.102



COMPONENT LOCATIONS

COMPONENT LOCATIONS(18)

CL-18

PHOTO.103

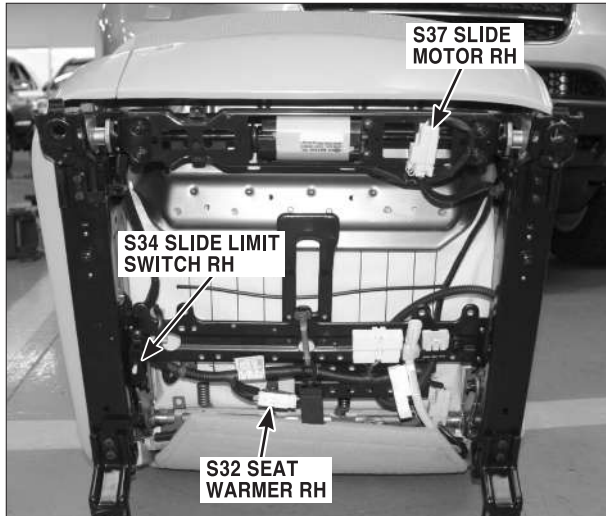

PHOTO.104

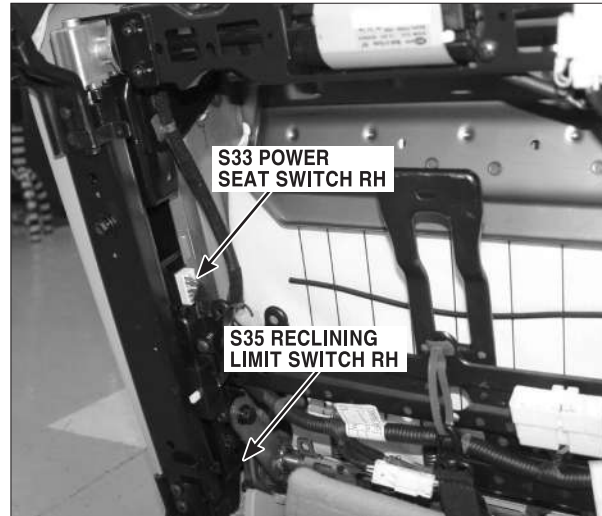

PHOTO.105

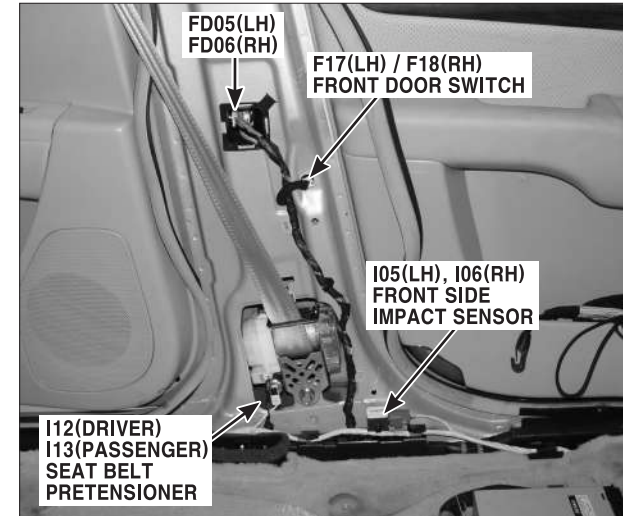

PHOTO.106

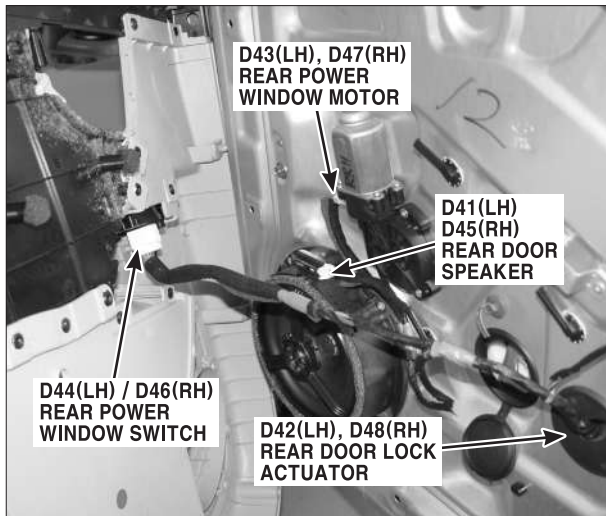

PHOTO.107

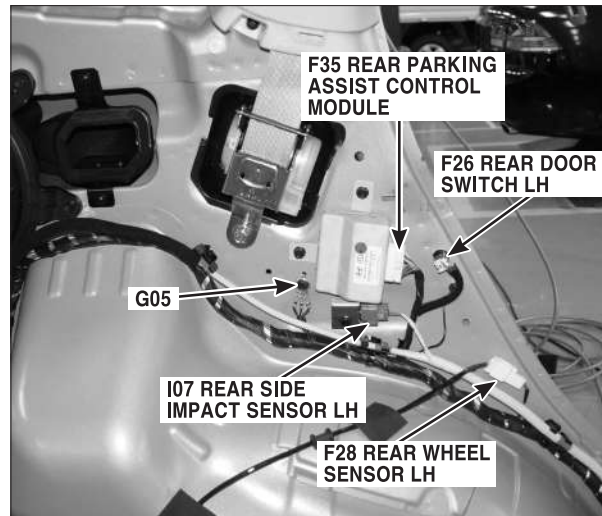
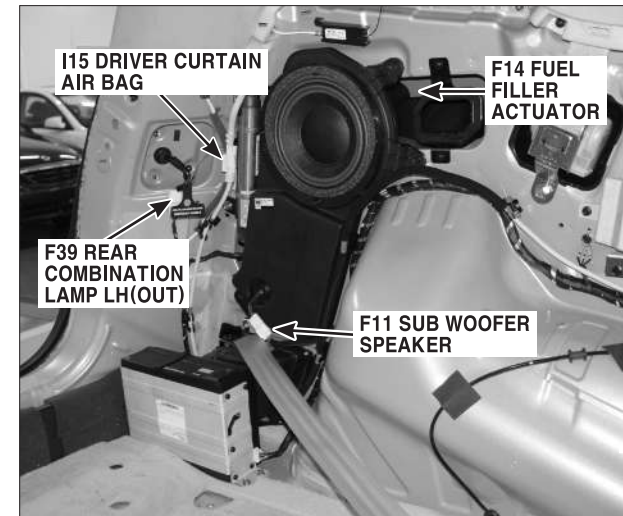

PHOTO.108



COMPONENT LOCATIONS

COMPONENT LOCATIONS(19)

CL-19

PHOTO.109

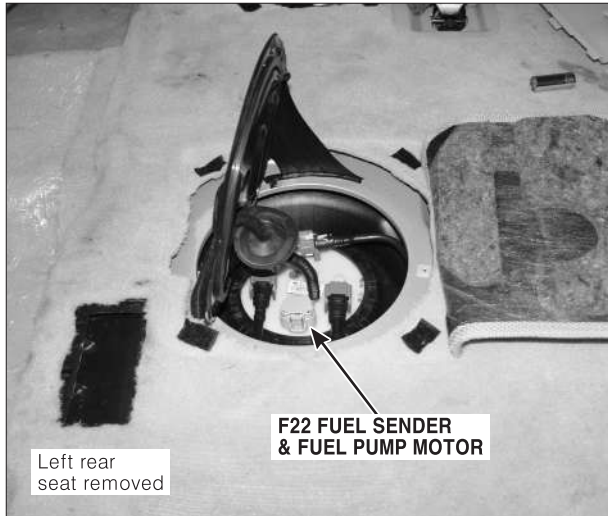

PHOTO.110

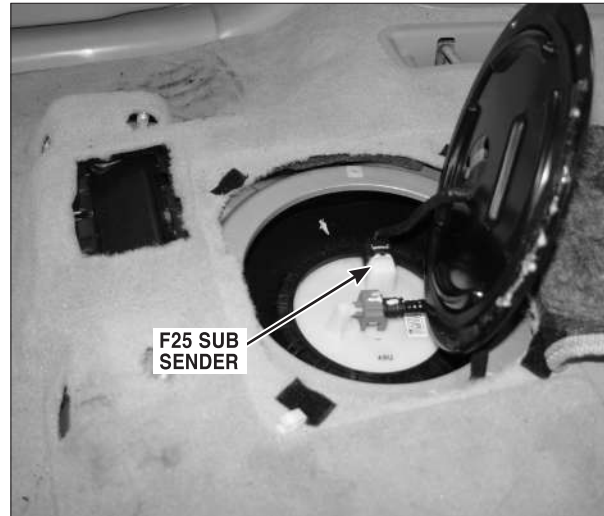

PHOTO.111

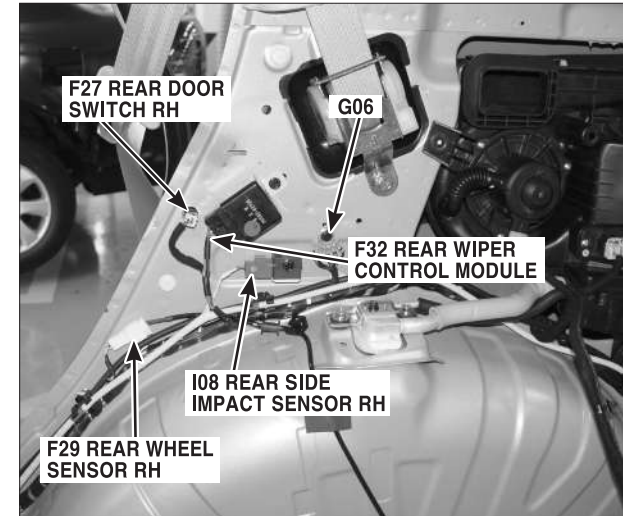

PHOTO.112

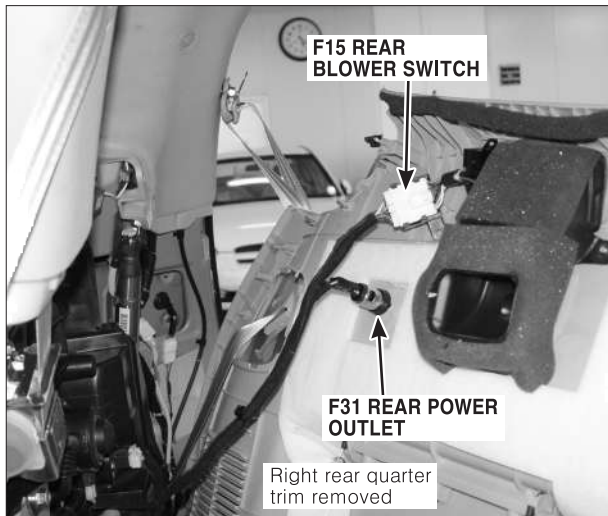

PHOTO.113

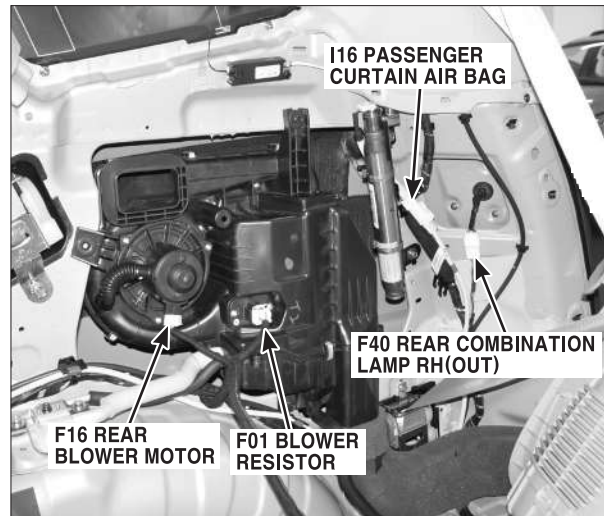
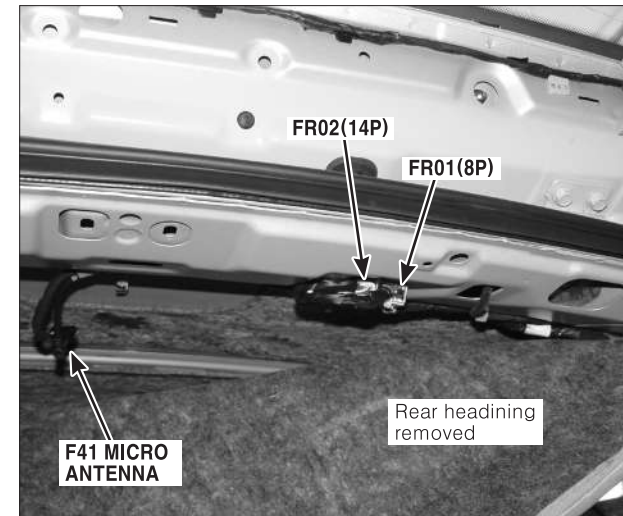

PHOTO.114



COMPONENT LOCATIONS

COMPONENT LOCATIONS(20)

CL-20

PHOTO.115



PHOTO.116

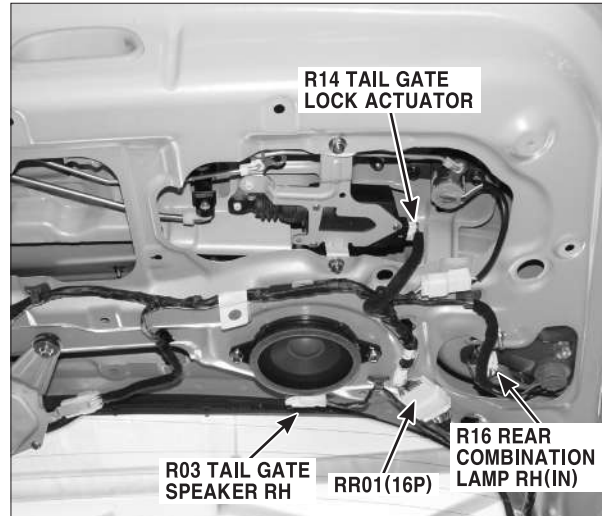

PHOTO.117

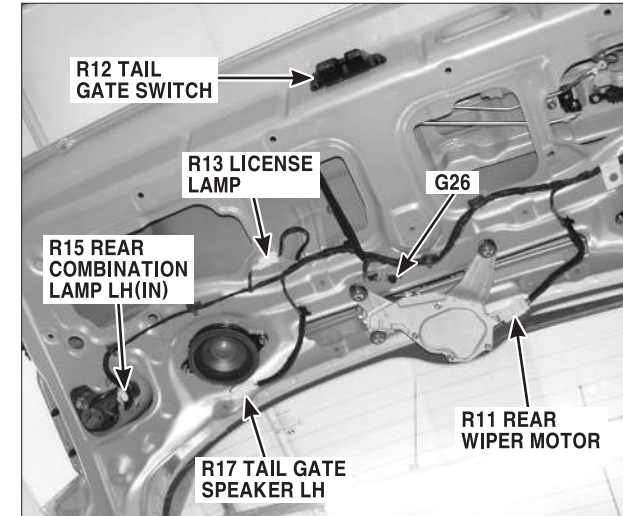

PHOTO.118



PHOTO.119



PHOTO.120

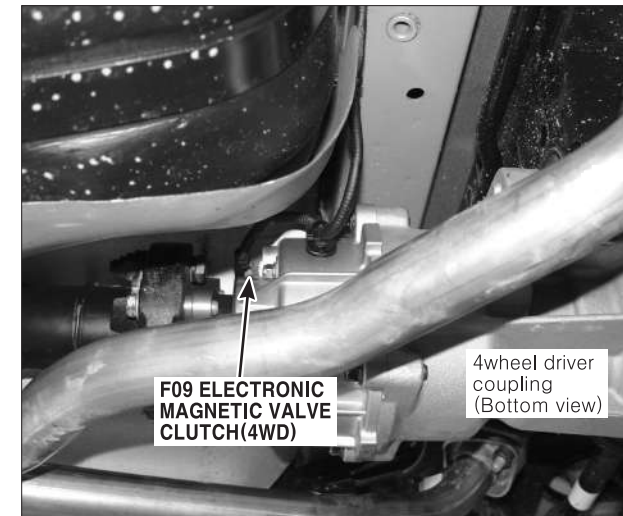

COMPONENT LOCATIONS

COMPONENT LOCATIONS(21)

CL-21

PHOTO.121

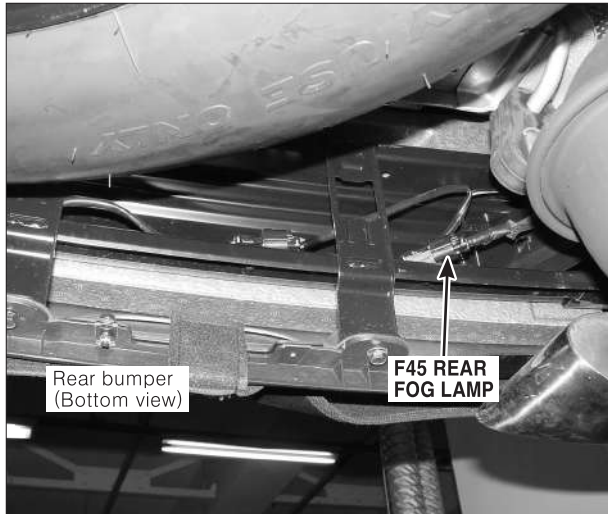

PHOTO.122

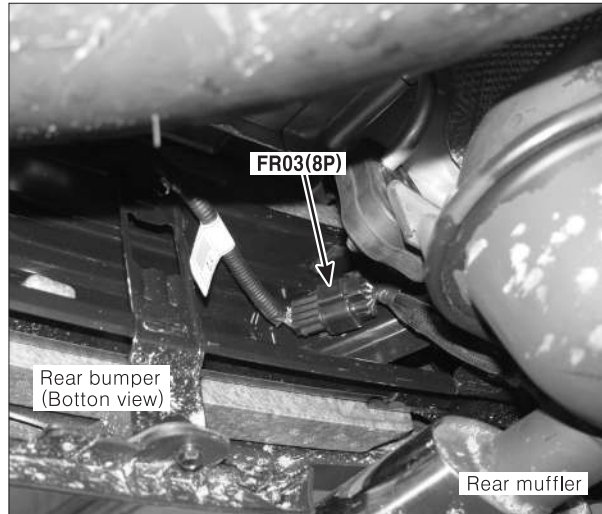

PHOTO.123

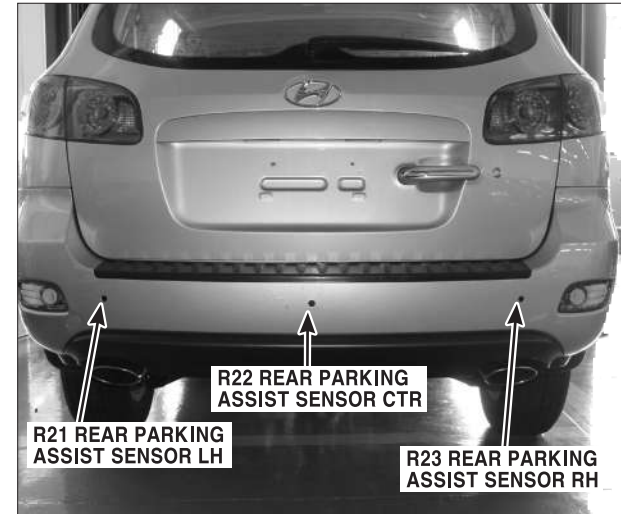

PHOTO.124

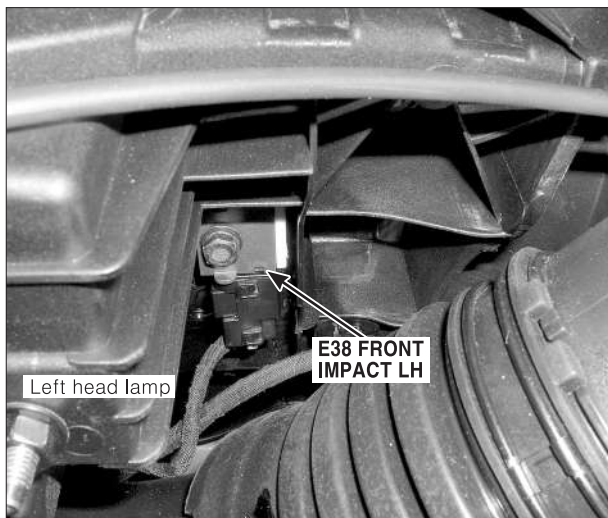

PHOTO.125

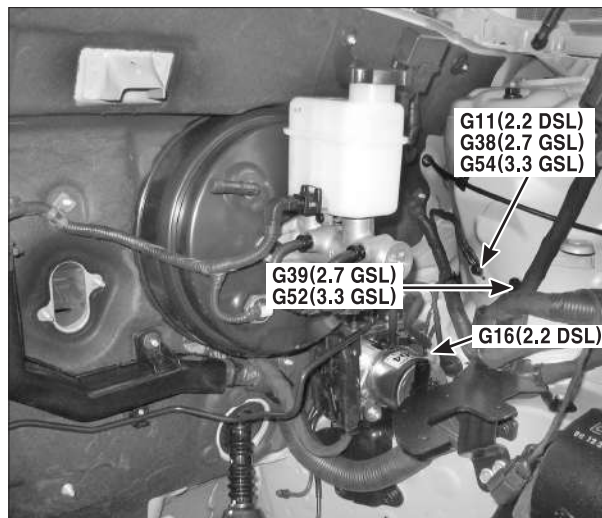
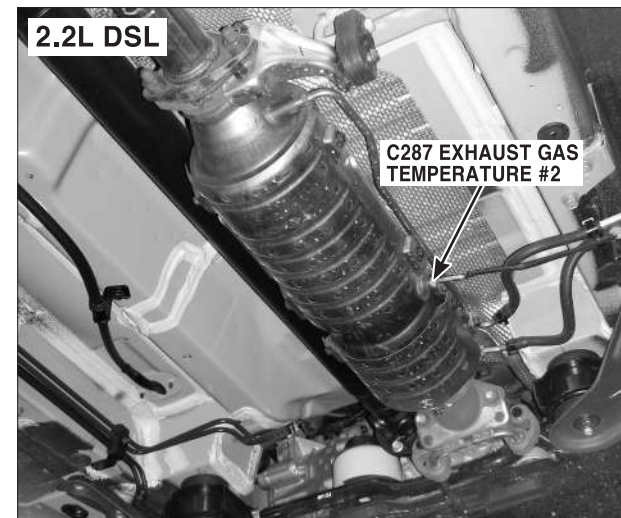

PHOTO.126



COMPONENT LOCATIONS

COMPONENT LOCATIONS(22)

CL-22

PHOTO.127

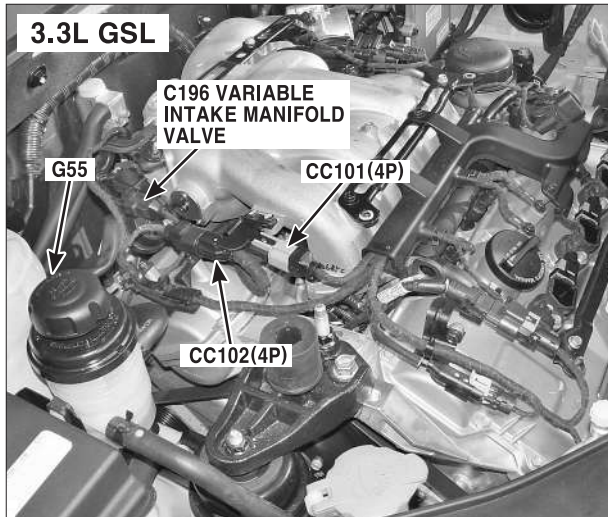

PHOTO.128



PHOTO.129

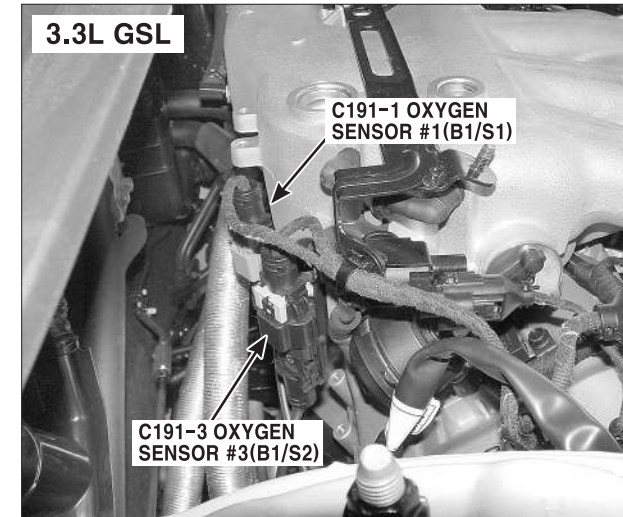

PHOTO.130

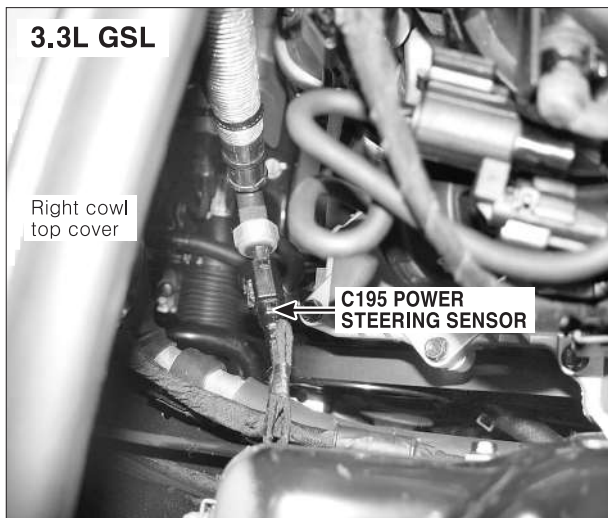

PHOTO.131

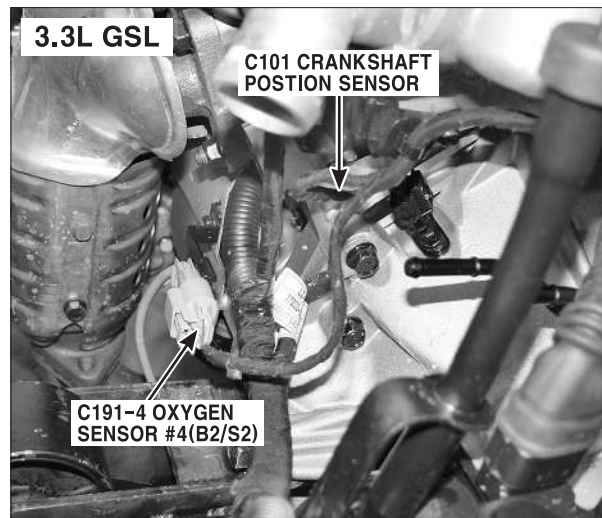
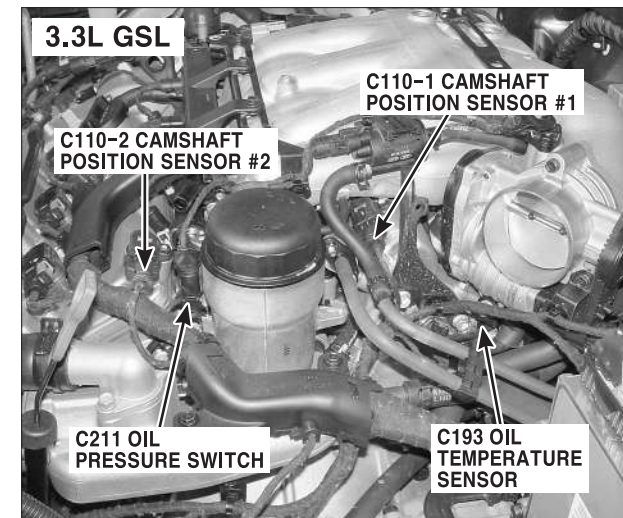

PHOTO.132



COMPONENT LOCATIONS

COMPONENT LOCATIONS(23)

CL-23

PHOTO.133

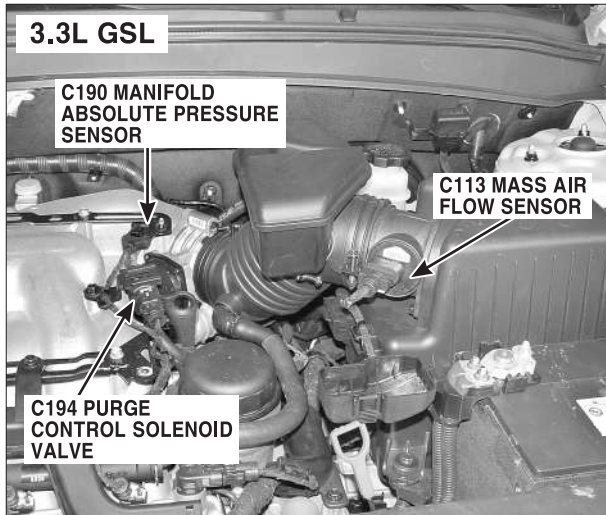

PHOTO.134

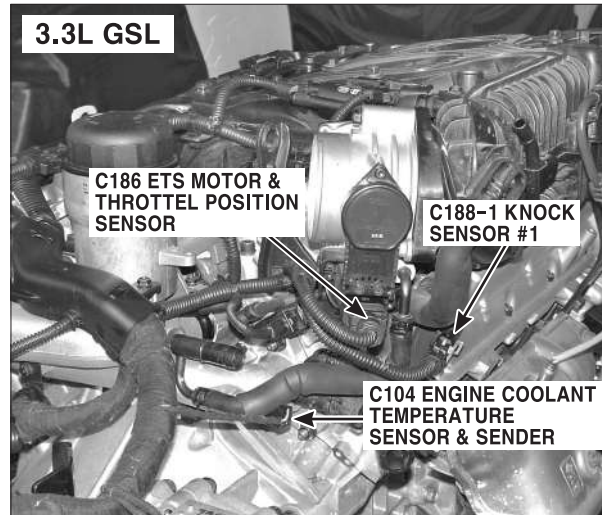

PHOTO.135

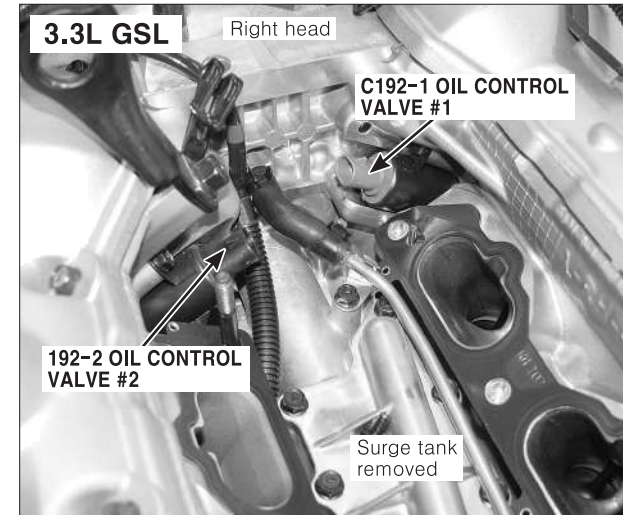

PHOTO.136

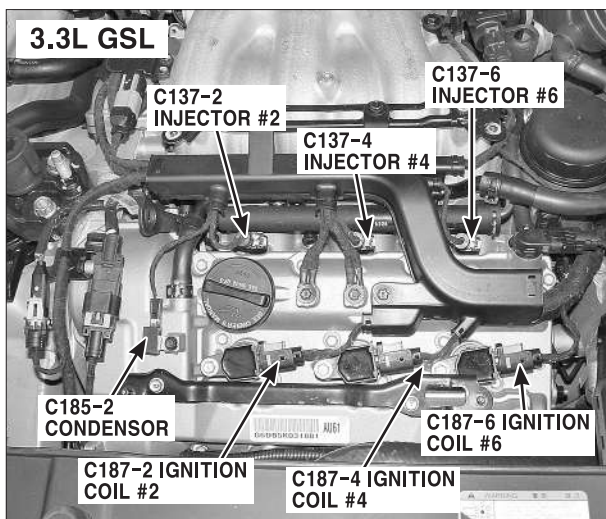
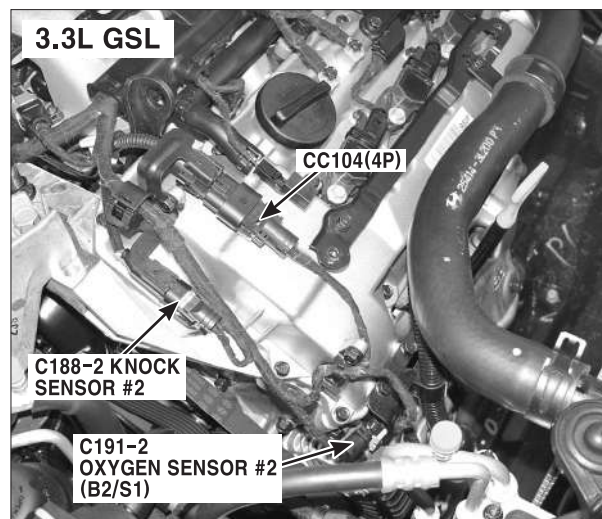
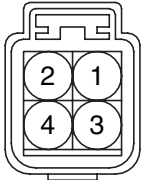
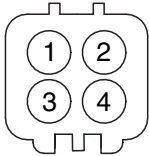
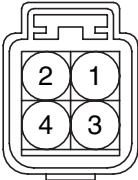
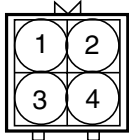

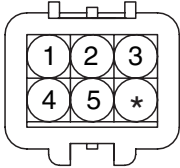

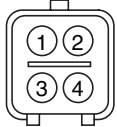
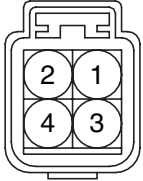
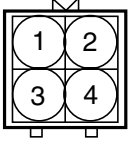
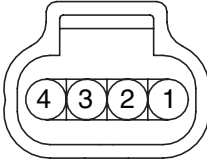
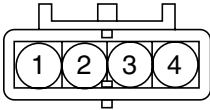

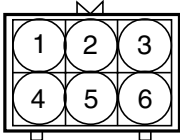
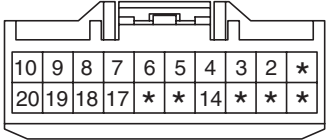
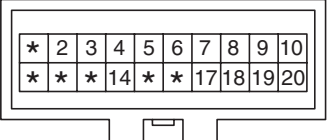
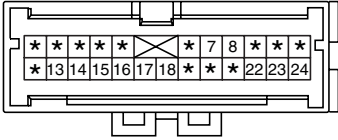
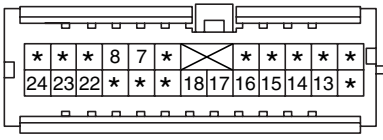

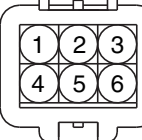

PHOTO.137



HARNESS CONNECTORS (1)		CC-1
<p>CC01</p>  <p>KUM_NMWP_04F_B</p>  <p>KUM_NMWP_04P_M</p>	<p>CC02</p>  <p>KUM_NMWP_04F_Gr</p>  <p>KUM_NMWP_4F_Gr</p>	
<p>CC03</p>  <p>KUM_NMWP_06F_B</p>  <p>KUM_NMWP_06M_B</p>	<p>CC101</p>  <p>KUM_KNMWP_04F_Gr</p>  <p>KUM_PM621_04120</p>	
<p>CC102</p>  <p>KUM_NMWP_04F_B</p>  <p>KUM_PB621_04021_C01</p>	<p>CC104</p>  <p>PKD_GT150_04F_B</p>  <p>CR04M044</p>	
<p>CC201</p>  <p>KUM_NMWP_06F_B</p>  <p>KUM_PB_621_06021</p>	<p>CF211</p>  <p>AMP_090III_20F_R</p>  <p>AMP_090III_20M_R_090</p>	
<p>EC211</p>  <p>AMP_040III_24M_B</p>  <p>AMP_040III_24F_B</p>	<p>EE01</p>  <p>KUM_NMWP_06F_B</p>  <p>KUM_NMWP_06M_B</p>	

HARNES CONNECTORS

HARNES CONNECTORS (2)

CC-2

EE201



CR04F094

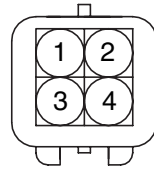

AMP_MCP_04M_B

EM11

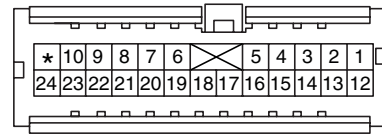

AMP_040III_24F_G

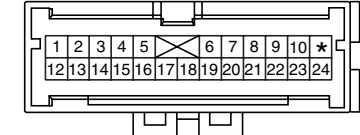

AMP_040III_24M_G

EM21

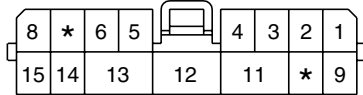

AMP_0725_15F_W



AMP_0725_15M_W

FD01

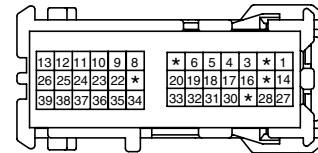

KET_LIF0409_39F_W

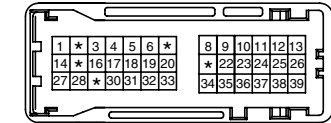

KET_LIF0409_39M_W_DR

FD03

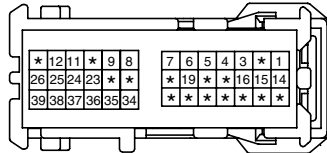

KET_LIF0409_39F_W

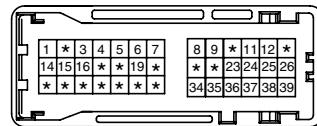

KET_LIF0409_39M_W_DR

FD05

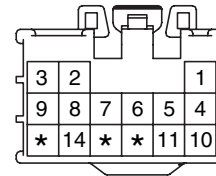

KET_090III_15F_W

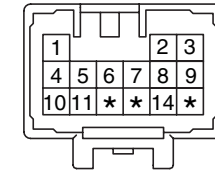

KET_090III_15M_W

FD06

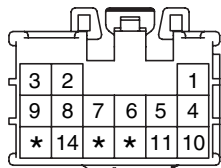

KET_090III_15F_W

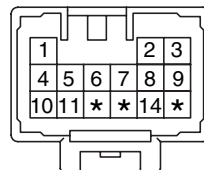

KET_090III_15M_W

FF01

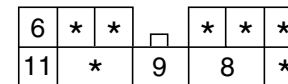

CR11F004

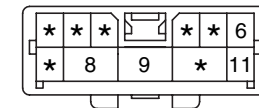

AMP_0725_11M_W_HD

FR01

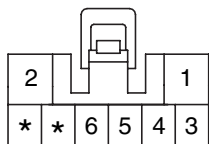

KET_2507_08F_W

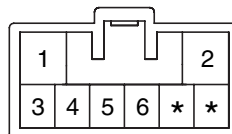

KET_2507_08M_W

FR02

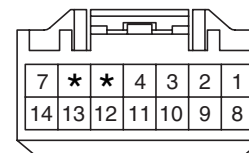

AMP_090III_14F_G

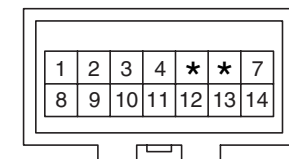

AMP_090III_14M_G

HARNESS CONNECTORS

HARNESS CONNECTORS (3)

CC-3

FR03

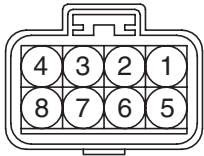

KUM_NMWP_08F_B_090

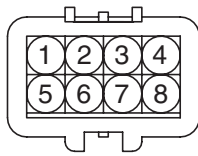

KUM_NMWP_08M_B

FS01

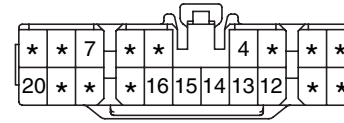

KET_090II_20F_W

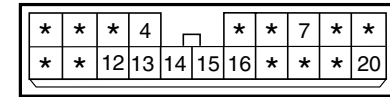

CR20M002

FS02

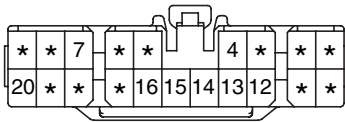

KET_090II_20F_W

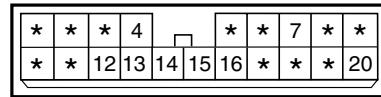

CR20M002

MC211

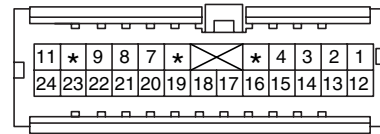

AMP_040III_24F_L

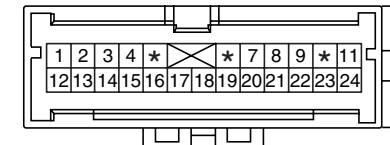

AMP_040III_24M_L

MC221

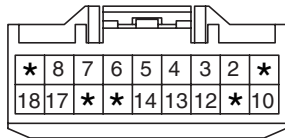

AMP_090III_18F_G

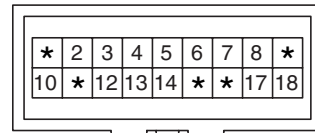

AMP_090III_18M_G

MC231

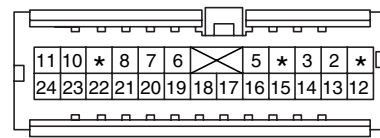

AMP_040III_24F_Br

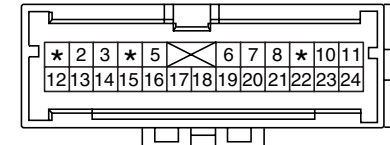

AMP_040III_24M_Br

MC241

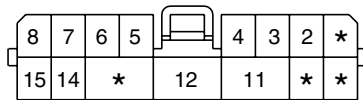

AMP_0725_15F_W

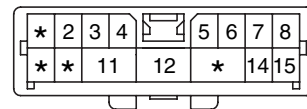

AMP_0725_15M_W

MF11

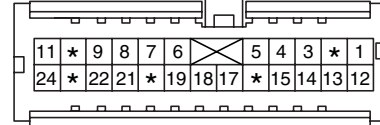

AMP_040III_24F_Br

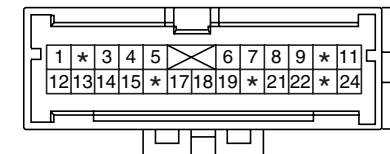

AMP_040III_24M_Br

MF31

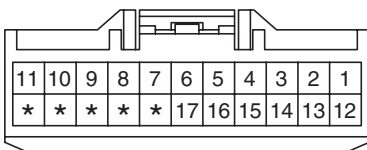

AMP_090III_22F_L

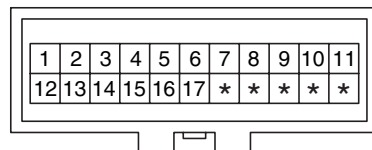

AMP_090III_22M_L

MF61

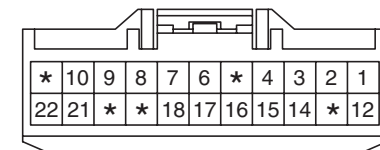

AMP_090III_22F_Y

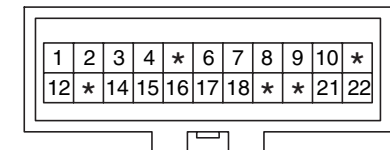

AMP_090III_24M_Y

HARNES CONNECTORS

HARNES CONNECTORS (4)

CC-4

MM03

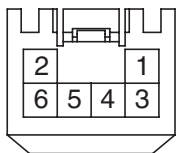

AMP_090III_06F_2_Br

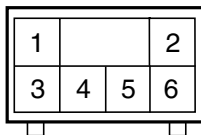

CR06M013

RR01

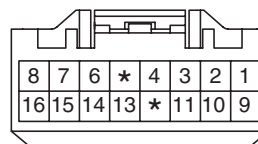

AMP_090III_16F_W

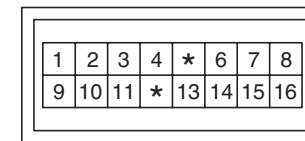

AMP_090III_16M_W

ENGINE COMPARTMENT JUNCTION BOX (1)

CC-5

U/H-B

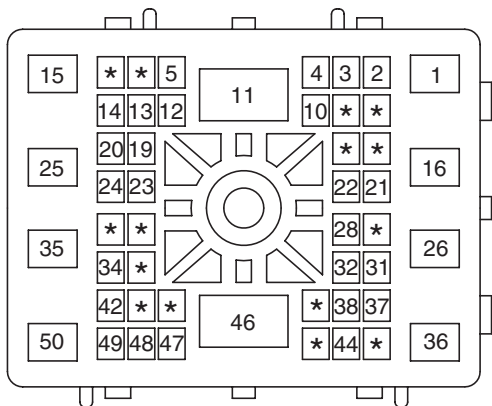

KET_MULTIBOX_50F_B

U/H-C

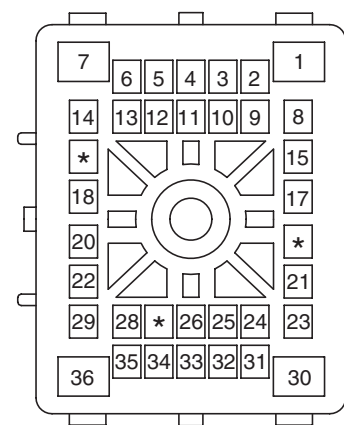

KET_MULTIBOX_36F_B_C

U/H-D

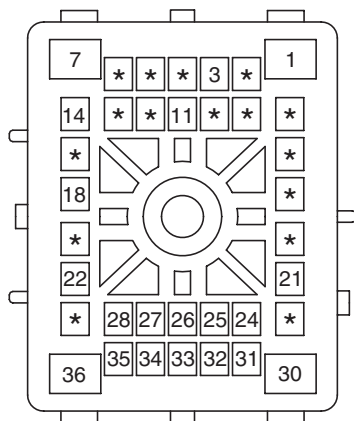

KET_MULTIBOX_36F_B_B

U/H-U

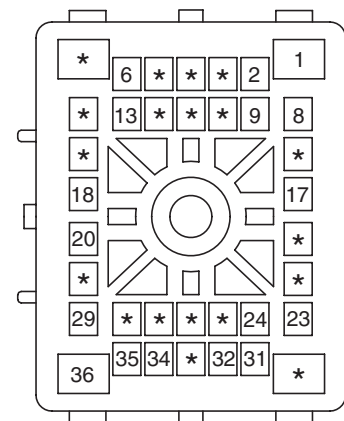

KET_MULTIBOX_36F_B_D

PASSENGER COMPARTMENT JUNCTION BOX & JOINT CONNECTORS EC8E1BAC

PASSENGER COMPARTMENT JUNCTION BOX & JOINT CONNECTORS (1) CC-6

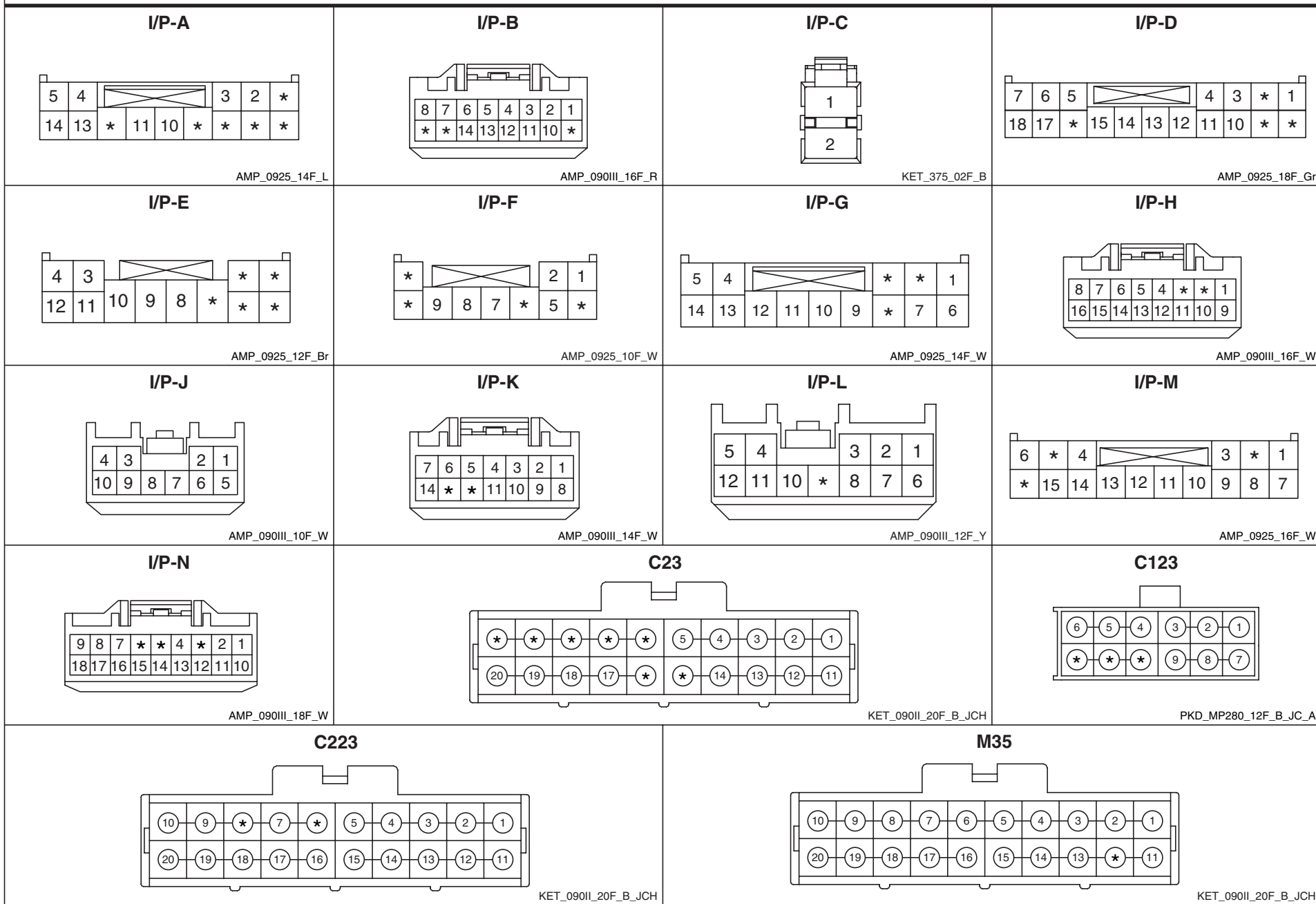

MAIN & AIR BAG HARNESS (1)

HL-1

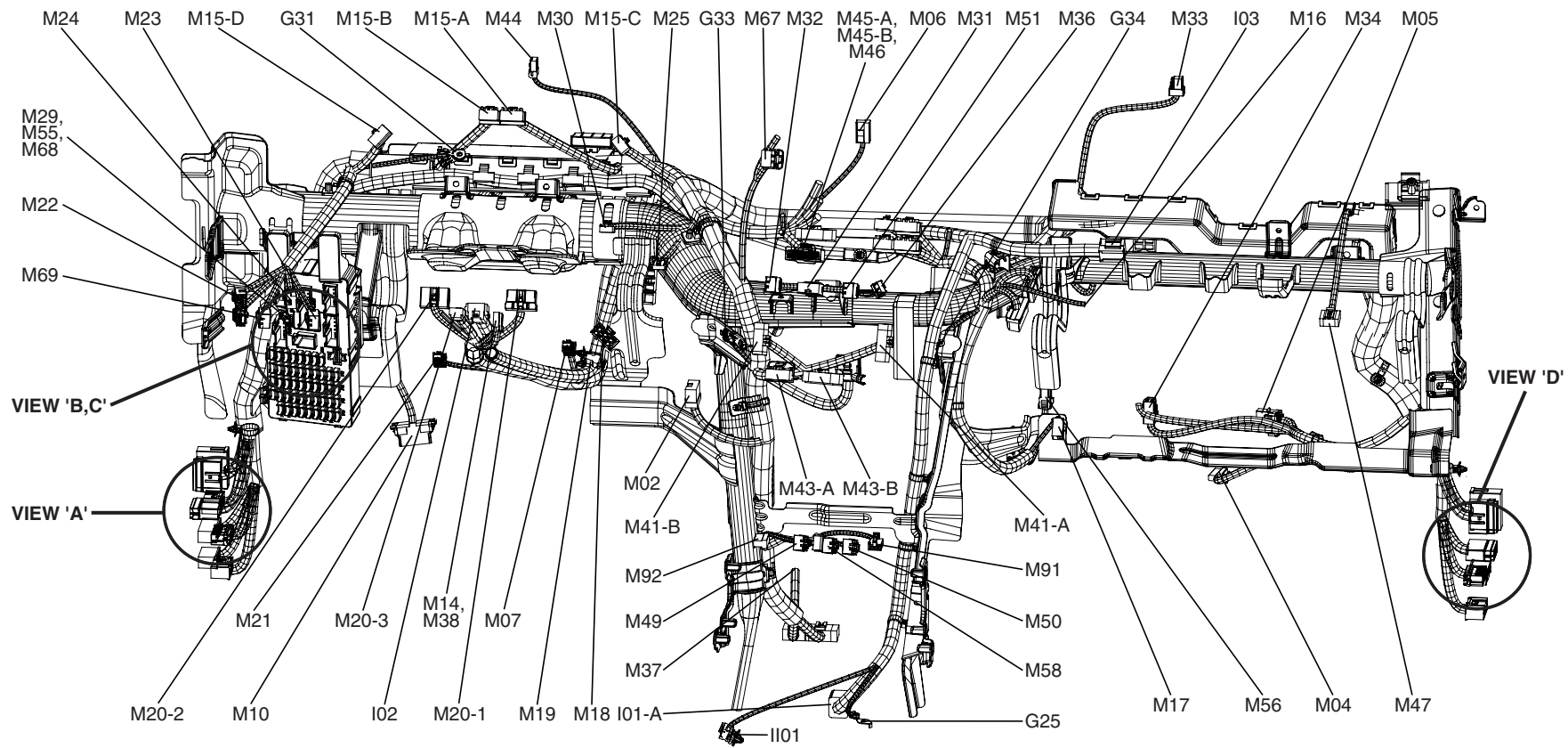

VIEW 'A'

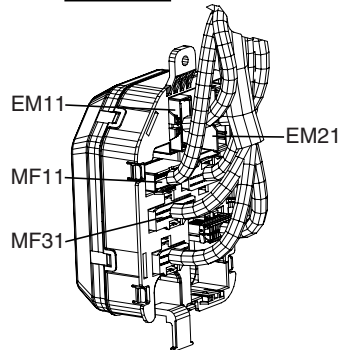

VIEW 'B'

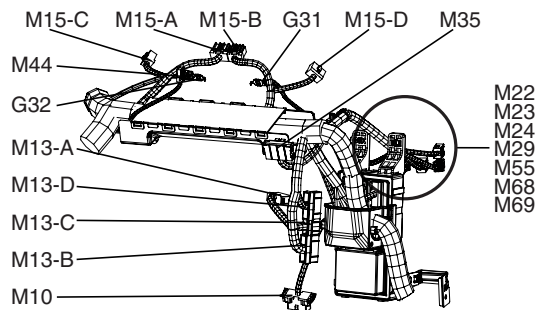

VIEW 'C'

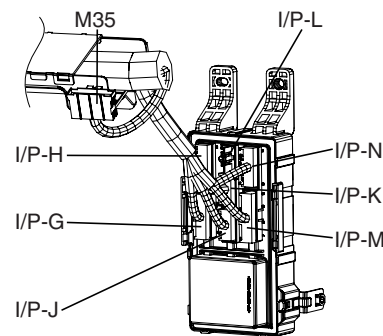

VIEW 'C'

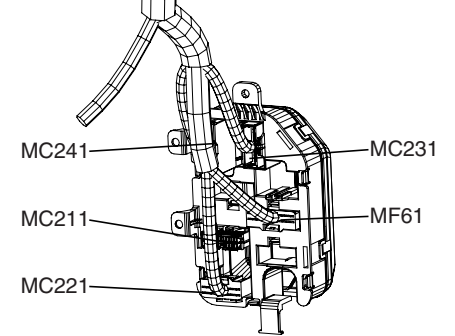

MAIN & AIR BAG HARNESS

MAIN & AIR BAG HARNESS (2)

HL-2

MAIN HARNESS

ICM-A	ICM Relay Box	M36	Rear A/Con Switch
ICM-B	ICM Relay Box	M37	Oil Level Sensor Module
M02	ATM Key Lock Control Module	M38	Steering Angle Sensor (With ESP)
M03	Water Temperature Sensor	M41-A	A/C Control Module (Auto)
M04	Blower Motor	M41-B	A/C Control Module (Auto)
M06	Center Speaker	M43-A	A/C Control Module (Manual)
M07	Ignition Key ILL. & Door Warning Switch	M43-B	A/C Control Module (Manual)
M10	Data Link Connector	M44	Security Indicator
M11	Key Solenoid	M45-A	Delphi Audio
M12	Evaporator Sensor	M45-B	Delphi Audio
M13-A	BCM (Body Control Module)	M46	Mobis Audio
M13-B	BCM (Body Control Module)	M47	PAB Cut Off Switch
M13-C	BCM (Body Control Module)	M49	Seat Warmer Switch LH
M13-D	BCM (Body Control Module)	M50	Seat Warmer Switch RH
M14	Steering Angle Sensor (W/O ESP)	M51	Rear Defogger Switch
M15-A	Instrument Cluster	M55	Front Fog Lamp Switch (Only Front)
M15-B	Instrument Cluster	M56	Temperature Actuator (LHD)
M15-C	Instrument Cluster	M56A	Temperature Actuator (RHD)
M15-D	Instrument Cluster	M57	Driver Temperature Actuator (LHD)
M16	Glove Box Lamp	M57A	Driver Temperature Actuator (RHD)
M17	Glove Box Switch	M58	4WD Lock Switch
M18	Ignition Switch	M66	Ashtray ILL.
M19	Rear Parking Assist Warning Buzzer	M67	Digital Clock
M20-1	Multifunction Switch (Wiper)(LHD)	M68	Front Fog Lamp Switch (Front + Rear)
M20-1A	Multifunction Switch (Wiper)(RHD)	M69	Rear Fog Lamp Switch (Front + Rear)
M20-2	Multifunction Switch (Light)(LHD)	EM11	Connection With ENGINE Harness
M20-2A	Multifunction Switch (Light)(RHD)	EM21	Connection With ENGINE Harness
M20-3	Multifunction Switch (Remocon)	I/P-G	Connection With I/P JUNCTION BOX Harness
M21	Immobilizer Module	I/P-H	Connection With I/P JUNCTION BOX Harness
M22	Head Lamp Leveling Switch	I/P-J	Connection With I/P JUNCTION BOX Harness
M23	ESP Switch	I/P-K	Connection With I/P JUNCTION BOX Harness
M24	Rheostat	I/P-M	Connection With I/P JUNCTION BOX Harness
M25	Incar & Humidity Sensor	I/P-N	Connection With I/P JUNCTION BOX Harness
M26	Intake Actuator (LHD)	MC211	Connection With CONTROL Harness
M26A	Intake Actuator (RHD)	MC221	Connection With CONTROL Harness
M28	Mode Actuator (LHD)	MC231	Connection With CONTROL Harness
M28A	Mode Actuator (LHD)	MC241	Connection With CONTROL Harness
M29	Rear Fog Lamp Switch (Only Rear)	MF11	Connection With FLOOR Harness
M30	ODO Trip Switch	MF31	Connection With FLOOR Harness
M31	Front Defroster Switch	MF61	Connection With FLOOR Harness
M32	Hazard Switch	MM03	Connection With SOCKET EXT. Harness
M33	Auto Light & Photo Sensor	G31	Ground
M34	FET (Field Effect Transistor)	G32	Ground
M35	Joint Connector	G33	Ground

G34	Ground
G36	Ground
Z01	Diode (Front Fog Lamp)
Z02	Pre-Excitation Resistor

FRONT SOCKET EXT. HARNESS

M91	Front Power Outlet
M92	Cigarette Lighter
MM03	Connection With MAIN Harness

AIR BAG HARNESS

I01-A	SRS Control Module
I02	Driver Air Bag
I03	Passenger Air Bag
I/P-L	Connection With I/P JUNCTION BOX Harness
G25	Ground

FRONT/ FRONT END MODULE/ BATTERY HARNESS (1)

HL-3

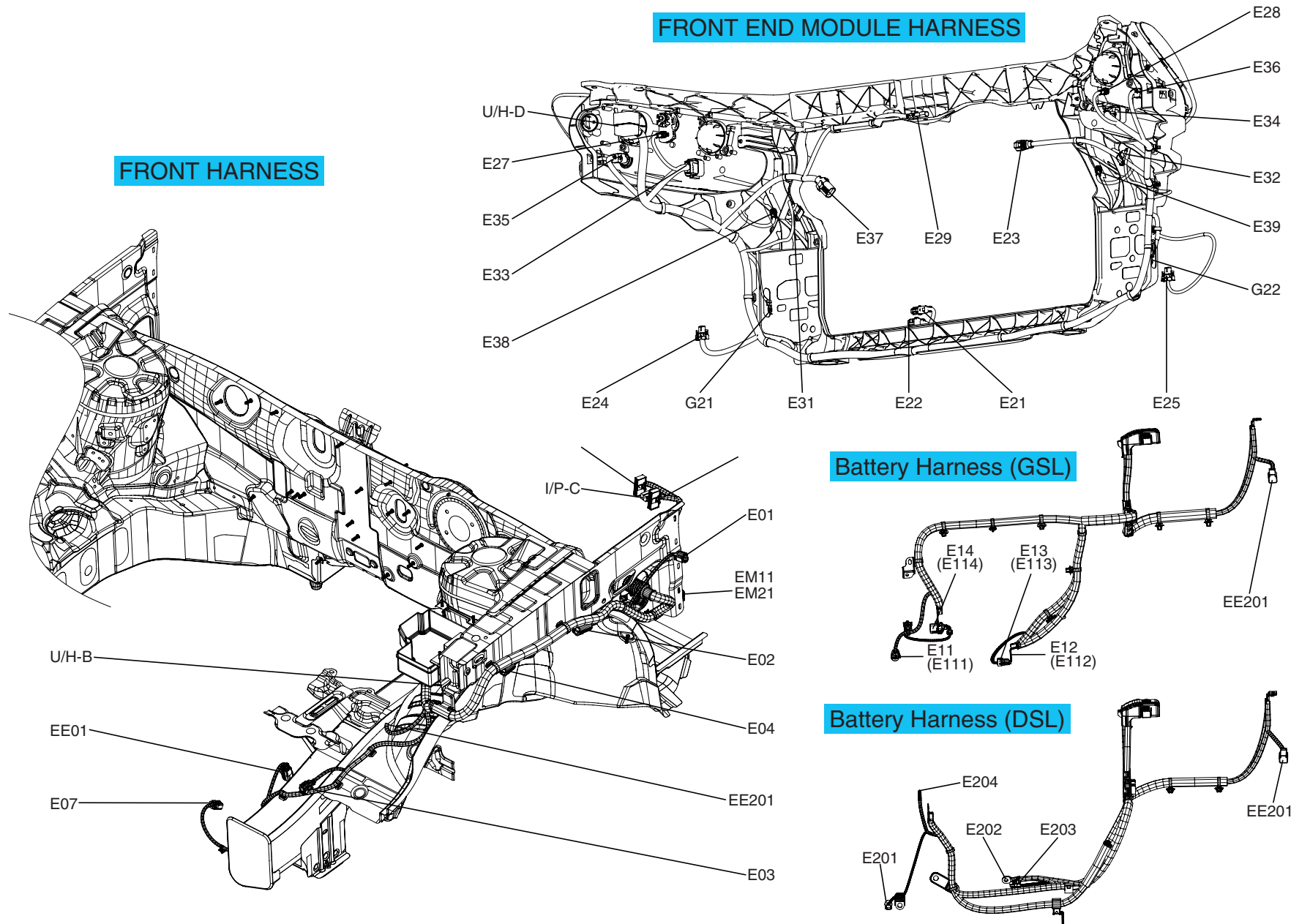

FRONT/ FRONT END MODULE/ BATTERY HARNESS

FRONT/ FRONT END MODULE/ BATTERY HARNESS (2)

HL-4

FRONT HARNESS

E01 Side Repeater Lamp LH
E02 Front Wheel Sensor LH
E03 Burglar Alarm Horn
E05 Ignition Lock Switch(RHD)
E06 Foot Brake Switch
E07 Semi Active Solenoid
E08 Accel Pedal Position Sensor(RHD)
E09 Clutch Switch(RHD)
E10 Stop Lamp Switch(RHD)
EC211 Connection with CONTROL harness
EE01 Connection with FRONT END MODULE harness
EE201 Connection With BATTERY Harness
EM11 Connection With MAIN Harness
EM21 Connection With MAIN Harness
I/P-A Connection With I/P JUNCTION BOX Harness
I/P-C Connection With I/P JUNCTION BOX Harness
I/P-E Connection With I/P JUNCTION BOX Harness
U/H-B Connection With U/H JUNCTION BOX Harness

BATTERY HARNESS (2.7L)

E11 A/C Compressor
E12 Start Motor
E13 Start Solenoid
E14 Generator
EE201 Connection With FRONT Harness

BATTERY HARNESS (3.3L)

E111 A/C Compressor
E112 Start Motor
E113 Start Solenoid
E114 Generator
EE201 Connection With FRONT Harness

FRONT END MODULE HARNESS

E21 Ambient Sensor
E22 AQS Sensor
E23 Condenser Fan Motor
E24 Front Fog Lamp LH
E25 Front Fog Lamp RH
E27 Head Lamp Leveling Actuator LH
E28 Head Lamp Leveling Actuator RH
E29 Hood Switch
E31 Horn LH
E32 Horn RH
E33 Head Lamp LH
E34 Head Lamp RH
E35 Position Lamp LH
E36 Position Lamp RH
E37 Radiator Fan Motor
E38 Front Impact Sensor LH
E39 Front Impact Sensor RH
EE01 Connection with FRONT harness
U/H-D Connection With U/H JUNCTION BOX Harness
G21 Ground
G22 Ground

BATTERY HARNESS (DSL)

E201 A/C Compressor
E202 Start Motor
E203 Start Solenoid
E204 Generator
EE201 Connection With FRONT Harness

CONTROL HARNESS (DSL 2.2L) (1)

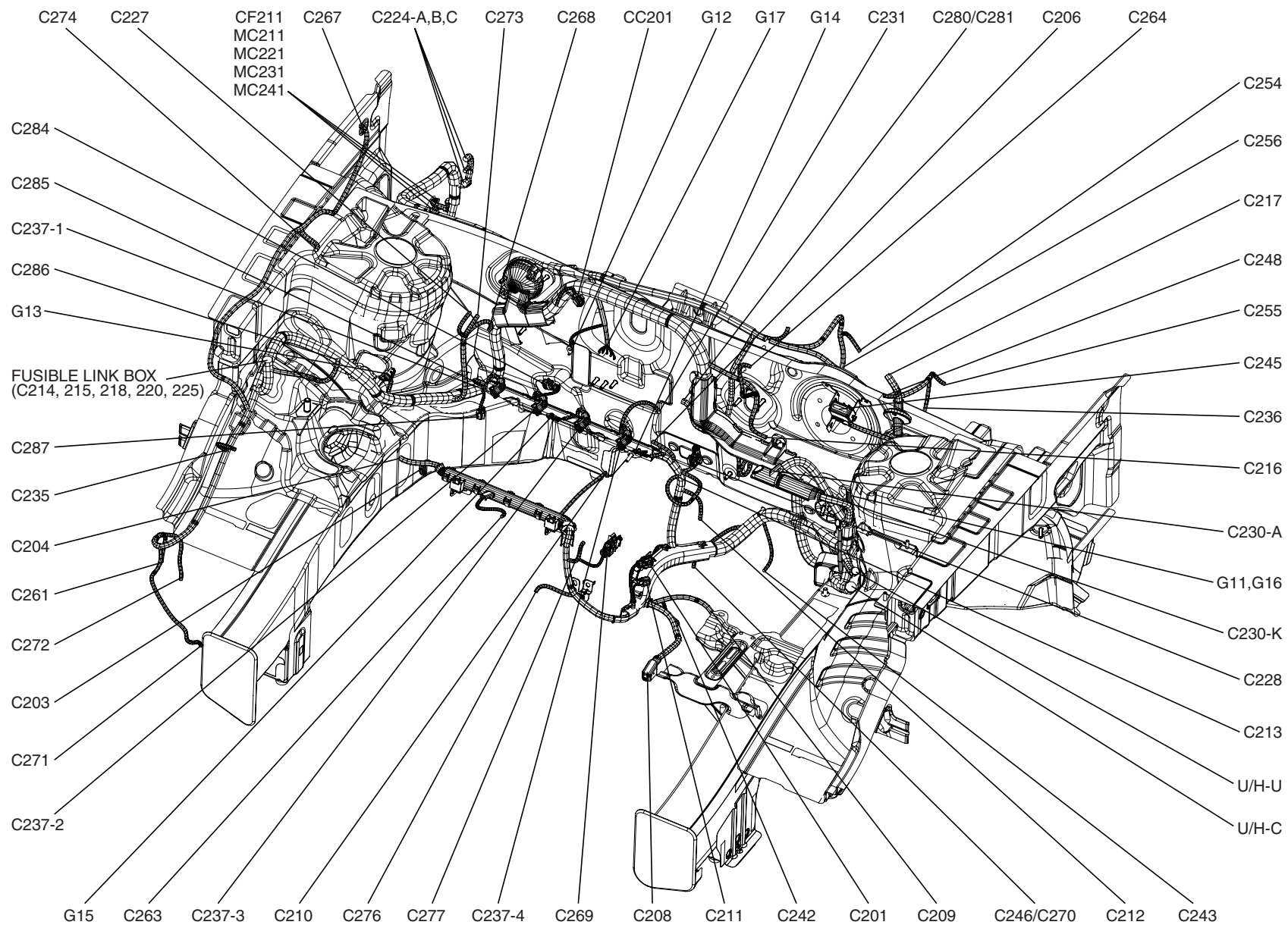

CONTROL HARNESS

CONTROL HARNESS (GSL 2.7L) (3)

HL-7

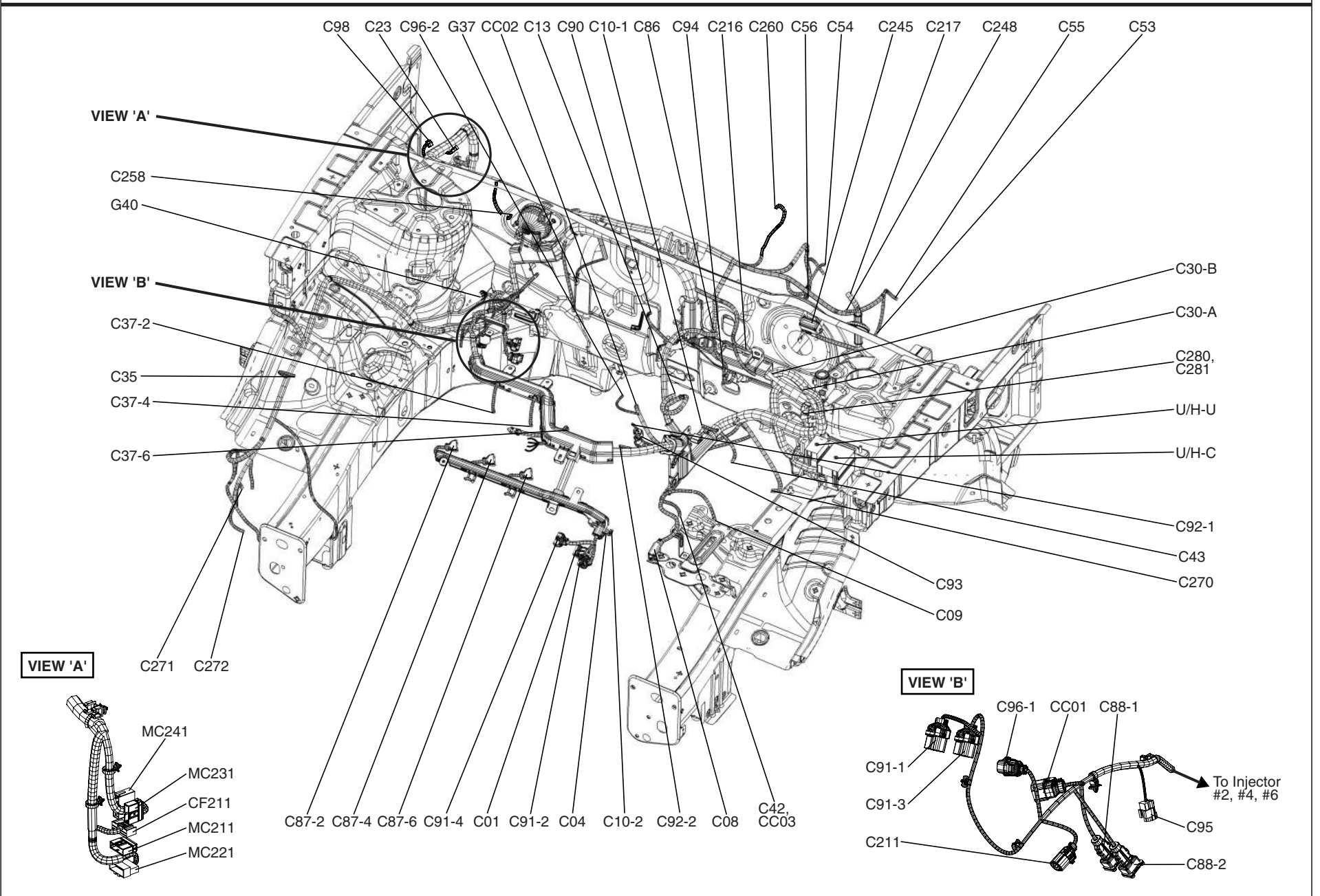

CONTROL HARNESS

CONTROL HARNESS (GSL 2.7L) (4)

HL-8

CONTROL HARNESS

C01 Crankshaft Position Sensor
C04 Engine Coolant Temperature Sensor & Sender
C08 Transaxle Range Switch
C09 ATM Solenoid Valve
C10-1 Camshaft Position Sensor #1
C10-2 Camshaft Position Sensor #2
C13 Mass Air Flow Sensor
C23 Joint Connector
C30-A PCM
C30-B PCM
C35 A/C Pressure Transducer
C37-2 Injector #2
C37-4 Injector #4
C37-6 Injector #6
C42 Input Speed Sensor
C43 Output Speed Sensor
C53 Clutch Switch
C54 Stop Lamp Switch
C55 Ignition Lock Switch(M/T)
C56 Accel Position Sensor
C85 Condensor
C86 ETC Motor & Throttle Position Sensor
C87-2 Ignition Coil #2
C87-4 Ignition Coil #4
C87-6 Ignition Coil #6
C88-1 Knock Sensor #1
C88-2 Knock Sensor #2
C90 Manifold Absolute Pressure Sensor
C91-1 Oxygen Sensor #1 (B1/S1)
C91-2 Oxygen Sensor #2 (B2/S1)
C91-3 Oxygen Sensor #3 (B1/S2)
C91-4 Oxygen Sensor #4 (B2/S2)
C92-1 Oil Control Valve #1
C92-2 Oil Control Valve #2
C93 Oil Temperature Sensor
C94 Purge Control Solenoid Valve
C95 Power Steering Switch
C96-1 Variable Intake Manifold Valve #1
C96-2 Variable Intake Manifold Valve #2
C98 Semi Active Engine Mounting Control Module
C211 Oil Pressure Switch
C216 Brake Fluid Level Sensor
C217 Front Wiper Motor
C245 Multipurpose Check Connector
C248 Windshield Defogger

C258 4WD ECM
C260 Yaw Rate Sensor
C267 Side Repeater Lamp RH
C270 Vehicle Speed Sensor (A/T)
C271 Washer Motor
C272 Washer Level Sensor
C274 Front Wheel Sensor RH
C280 ABS Control Module
C281 ESP Control Module
CC01 Connection With IGNITION EXT. Harness
CC02 Connection With INJECTOR EXT. Harness
CC03 Connection With MTM EXT. Harness
CF211 Connection With FLOOR Harness
EC211 Connection With FRONT Harness
MC211 Connection With MAIN Harness
MC221 Connection With MAIN Harness
MC231 Connection With MAIN Harness
MC241 Connection With MAIN Harness
U/H-C Connection With U/H JUNCTION BOX Harness
U/H-U Connection With U/H JUNCTION BOX Harness
G37 Ground
G38 Ground
G39 Ground
G41 Ground

IGNITION EXT. HARNESS

C87-1 Ignition Coil #1
C87-3 Ignition Coil #2
C87-5 Ignition Coil #3
CC01 Connection With CONTROL Harness

INTECTOR EXT. HARNESS

C37-1 Injector #1
C37-3 Injector #3
C37-5 Injector #5
CC02 Connection With CONTROL Harness

MTM EXT. HARNESS

C205 Back-Up Lamp Switch
C246 Vehicle Speed Sensor
CC03 Connection With CONTROL Harness

CONTROL HARNESS

CONTROL HARNESS (GSL 3.3L) (5)

HL-9

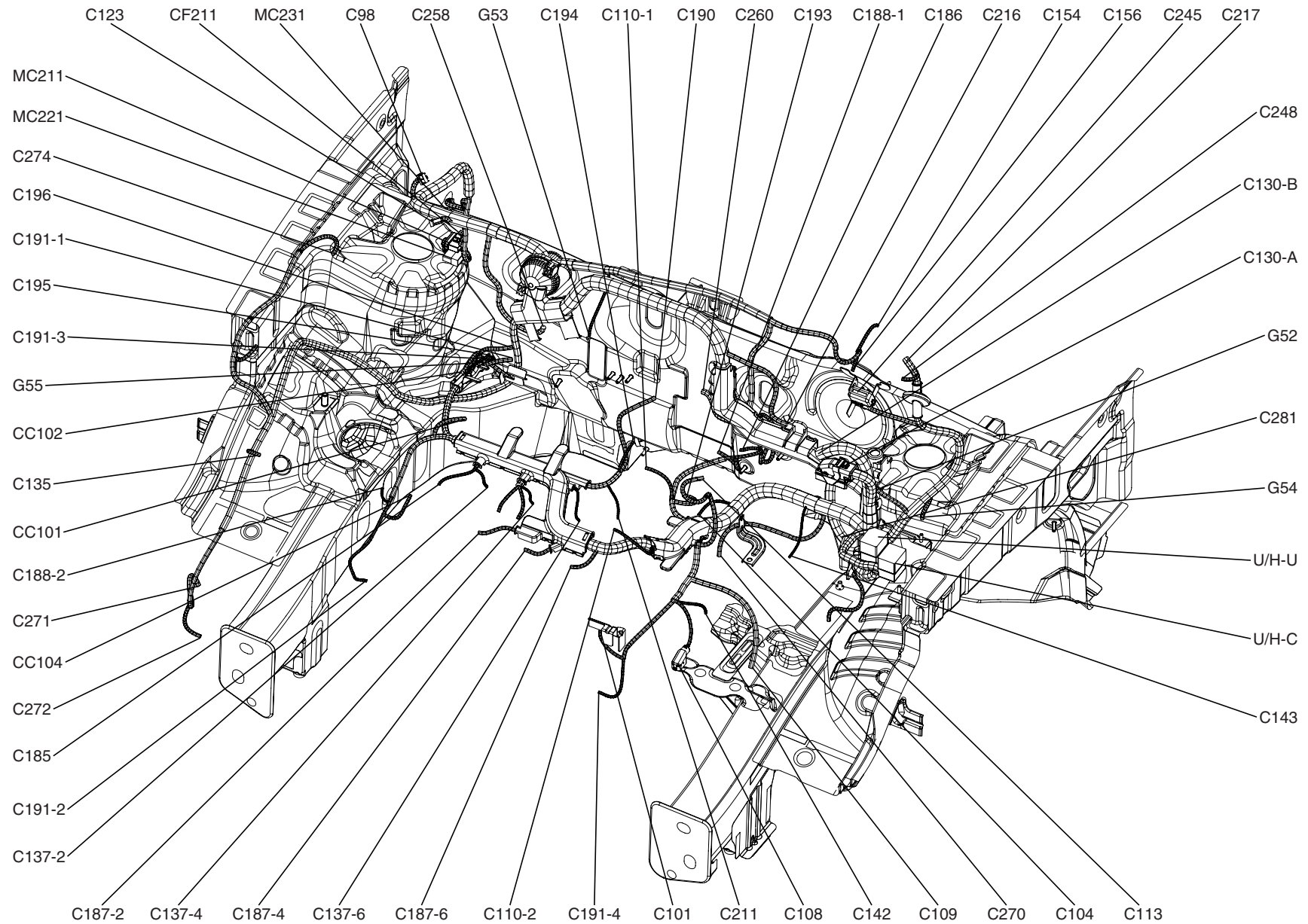

CONTROL HARNESS

CONTROL HARNESS (GSL 3.3L) (6)

HL-10

CONTROL HARNESS

C98 Semi Active Engine Mounting Control Module
C101 Crankshaft Position Sensor
C104 Engine Coolant Temperature Sensor & Sender
C108 Transaxle Range Switch
C109 ATM Solenoid Valve
C110-1 Camshaft Position Sensor #1
C110-2 Camshaft Position Sensor #2
C113 Mass Air Flow Sensor
C123 Joint Connector
C130-A PCM
C130-B PCM
C135 A/C Pressure Transducer
C137-2 Injector #2
C137-4 Injector #4
C137-6 Injector #6
C142 Pulse Generator #A
C143 Pulse Generator #B
C154 Stop Lamp Switch
C156 Accel Position Sensor
C185 Condenser #2
C186 ETC Motor & Throttle Position Sensor
C187-2 Ignition Coil #2
C187-4 Ignition Coil #4
C187-6 Ignition Coil #6
C188-1 Knock Sensor #1
C188-2 Knock Sensor #2
C190 Manifold Absolute Pressure Sensor
C191-1 Oxygen Sensor #1(B1/S1)
C191-2 Oxygen Sensor #2(B2/S1)
C191-3 Oxygen Sensor #3(B1/S2)
C191-4 Oxygen Sensor #4(B2/S2)
C193 Oil Temperature Sensor
C194 Purge Control Solenoid Valve
C195 Power Steering Switch
C196 Variable Intake Manifold Valve
C211 Oil Pressure Switch
C216 Brake Fluid Level Sensor
C217 Front Wiper Motor
C245 Multipurpose Check Connector
C248 Windshield Defogger
C258 4WD ECM
C260 Yaw Rate Sensor

C270 Vehicle Speed Sensor
C271 Washer Motor
C272 Washer Level Sensor
C274 Front Wheel Sensor RH
C281 ESP Control Module
CC101 Connection With IGNITION EXT. Harness
CC102 Connection With INJECTOR EXT. Harness
CC104 Connection With OCV EXT. Harness
CF211 Connection With FLOOR Harness
MC211 Connection With MAIN Harness
MC221 Connection With MAIN Harness
MC231 Connection With MAIN Harness
U/H-C Connection With U/H JUNCTION BOX Harness
U/H-U Connection With U/H JUNCTION BOX Harness
G52 Ground
G53 Ground
G54 Ground
G55 Ground

IGNITION EXT. HARNESS

C185-1 Condenser #1
C187-1 Ignition Coil #1
C187-3 Ignition Coil #3
C187-5 Ignition Coil #5
CC101 Connection With CONTROL Harness

INJECTOR EXT. HARNESS

C137-1 Injector #1
C137-3 Injector #3
C137-5 Injector #5
CC102 Connection With CONTROL Harness

OCV EXT. HARNESS

C192-1 Oil Control Valve #1
C192-2 Oil Control Valve #2
CC104 Connection With CONTROL Harness

FLOOR & REAR AIR BAG HARNESS (1)

HL-11

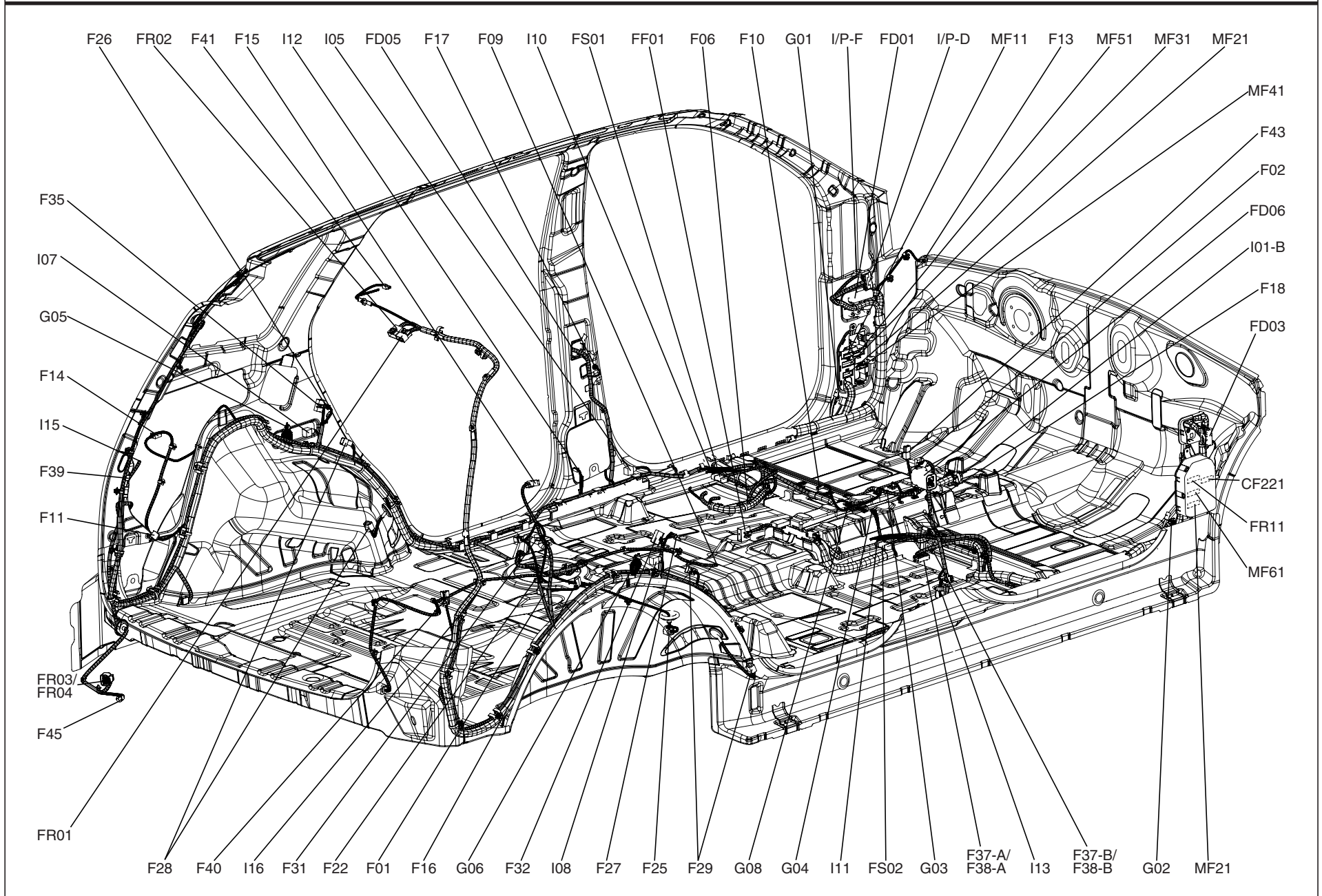

FLOOR & REAR AIR BAG HARNESS

FLOOR & REAR AIR BAG HARNESS (2)

HL-12

FLOOR HARNESS

F01 Blower Resistor
F02 Sports Mode Switch
F06 Seat Belt Switch
F09 Electronic Magnetic Valve Clutch
F10 Parking Brake Switch
F11 Sub Woofer Speaker
F13 Foot Brake Switch
F14 Fuel Filler Actuator
F15 Rear Blower Switch
F16 Rear Blower Motor
F17 Front Door Switch LH
F18 Front Door Switch RH
F22 Fuel Sender & Fuel Pump Motor
F25 Sub Sender
F26 Rear Door Switch LH
F27 Rear Door Switch RH
F28 Rear Wheel Sensor LH
F29 Rear Wheel Sensor RH
F31 Rear Power Outlet
F32 Rear Wiper Control Module
F35 Rear Parking Assist Control Module
F37-A Delphi Amp
F37-B Delphi Amp
F38-A Mobis Amp
F38-B Mobis Amp
F39 Rear Combination Lamp LH (OUT)
F40 Rear Combination Lamp RH (OUT)
F41 Micro Antenna
F42 Luggage Lamp
F43 A/T Change Lever ILL.
F45 Rear Fog Lamp
CF211 Connection With CONTROL Harness
FD01 Connection With DOOR Harness
FD03 Connection With DOOR Harness
FD05 Connection With DOOR Harness
FD06 Connection With DOOR Harness
FF01 Connection With CONSOLE EXT. Harness
FR01 Connection With TAIL GATE EXT. Harness
FR02 Connection With TAIL GATE EXT. Harness
FR03 Connection With B.W.S EXT. Harness

FS01 Connection With SEAT EXT. Harness
FS02 Connection With SEAT EXT. Harness
I/P-D Connection With I/P JUNCTION BOX Harness
I/P-F Connection With I/P JUNCTION BOX Harness
MF11 Connection With MAIN Harness
MF31 Connection With MAIN Harness
MF61 Connection With MAIN Harness
G01 Ground
G02 Ground
G03 Ground
G04 Ground
G05 Ground
G06 Ground

CONSOLE EXT. HARNESS

F30 Center Power Outlet
FF01 Connection With FLOOR Harness

REAR AIR BAG HARNESS

I01-B SRS Control Module
I05 Front Side Impact Sensor LH
I06 Front Side Impact Sensor RH
I07 Rear Side Impact Sensor LH
I08 Rear Side Impact Sensor RH
I10 Driver Side Air Bag
I11 Passenger Side Air Bag
I12 Driver Seat Belt Pretensioner
I13 Passenger Seat Belt Pretensioner
I15 Driver Curtain Air Bag
I16 Passenger Curtain Air Bag

DOOR & TAIL GATE HARNESS (1)

HL-13

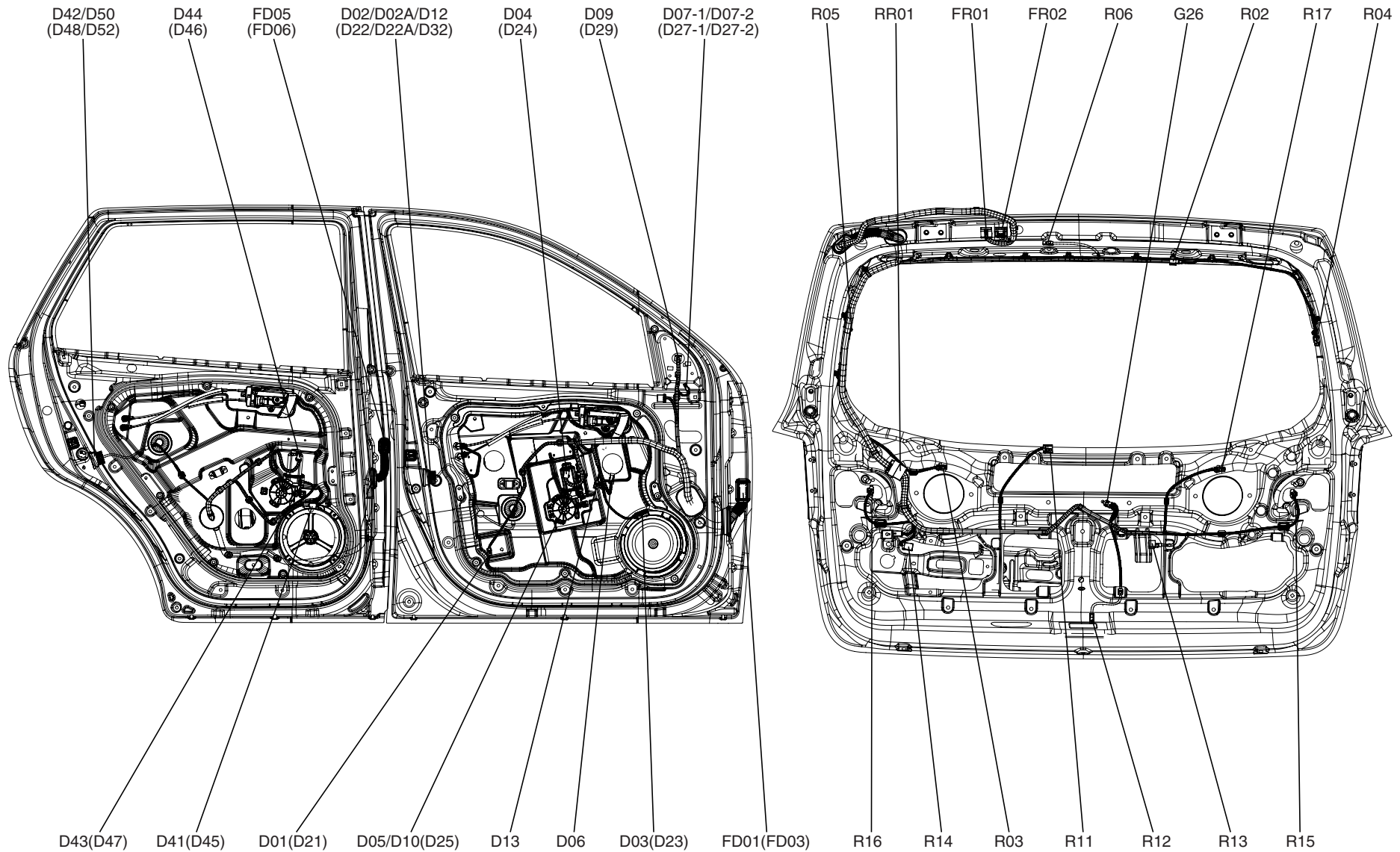

DOOR & TAIL GATE HARNESS

DOOR & TAIL GATE HARNESS (2)

HL-14

FRONT DOOR LH HARNESS

D01 Driver Door Lamp
D02 Driver Door Lock Actuator (LHD)
D02A Driver Door Lock Actuator (W/O Dade Lock)(RHD)
D03 Driver Door Speaker
D04 Driver Power Window Main Switch
D05 Driver Power Window Motor
D06 Driver Power Outside Mirror Switch
D07-1 Driver Tweeter Speaker (Delphi)
D07-2 Driver Tweeter Speaker (Mobis)
D09 Driver Power Outside Mirror Motor
D10 Driver Safety Power Window ECM
D12 Driver Door Lock Actuator (With Dade Lock)(RHD)
D13 Fuel Filler Switch
FD01 Connection With FLOOR Harness

FRONT DOOR RH HARNESS

D21 Passenger Door Lamp
D22 Passenger Door Lock Actuator (LHD)
D22A Passenger Door Lock Actuator (W/O Dade Lock)(RHD)
D23 Passenger Door Speaker RH
D24 Passenger Power Window Switch
D25 Passenger Power Window Motor
D27-1 Passenger Tweeter Speaker (Delphi)
D27-2 Passenger Tweeter Speaker (Mobis)
D29 Passenger Power Outside Mirror Motor
D32 Passenger Door Lock Actuator (With Dade Lock)(RHD)
FD03 Connection With FLOOR Harness

REAR DOOR LH HARNESS

D41 Rear Door Speaker LH
D42 Rear Door Lock Actuator LH (W/O Dade Lock)
D43 Rear Power Window Motor LH
D44 Rear Power Window Switch LH
D50 Rear Door Lock Actuator LH (With Dade Lock)
FD05 Connection With FLOOR Harness

REAR DOOR RH HARNESS

D45 Rear Door Speaker RH
D46 Rear Power Window Switch RH
D47 Rear Power Window Motor RH
D48 Rear Door Lock Actuator RH (W/O Dade Lock)
D52 Rear Door Lock Actuator RH (With Dade Lock)
FD06 Connection With FLOOR Harness

TAIL GATE EXT. HARNESS

R02 High Mounted Stop Lamp (Spoiler)
R03 Tail Gate Speaker RH
R04 Rear Defogger (+)
R05 Rear Defogger (-)
R06 High Mounted Stop Lamp
FR01 Connection With FLOOR Harness
FR02 Connection With FLOOR Harness
RR01 Connection With TAIL GATE Harness

TAIL GATE HARNESS

R11 Rear Wiper Motor
R12 Tail Gate Switch
R13 License Lamp
R14 Tail Gate Lock Actuator
R15 Rear Combination Lamp LH (IN)
R16 Rear Combination Lamp RH (IN)
R17 Tail Gate Speaker LH
RR01 Connection With TAIL GATE EXT. Harness
G26 Ground

B.W.S EXT. HARNESS

R21 Rear Parking Assist Sensor LH
R22 Rear Parking Assist Sensor CENTER
R23 Rear Parking Assist Sensor RH
FR03 Connection With FLOOR Harness

ROOF HARNESS (1)

HL-15

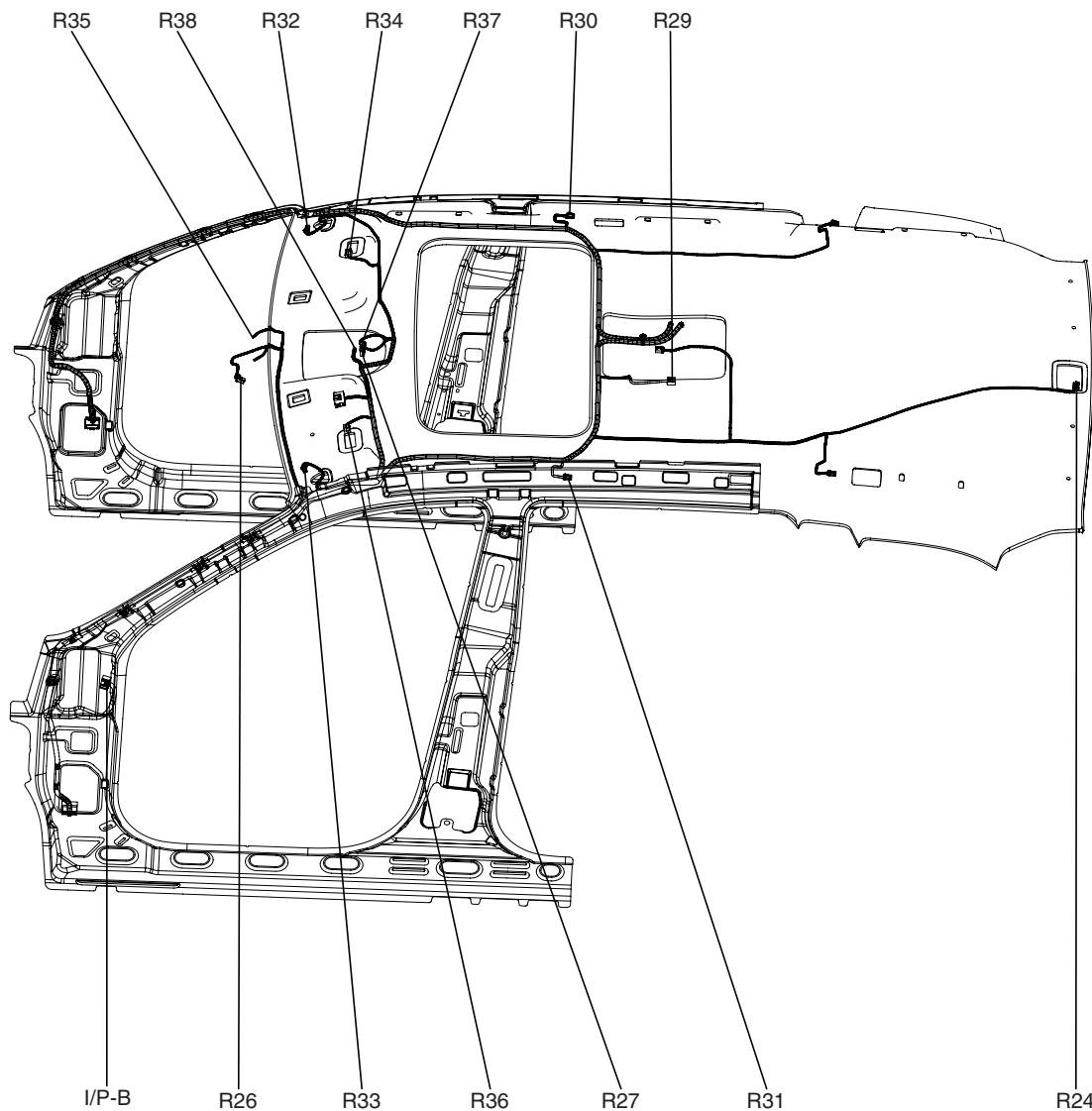

ROOF HARNESS

- R24 Cargo Lamp
- R26 Electro Chromic Mirror
- R27 Map Lamp
- R29 Room Lamp
- R30 Rear Personal Lamp RH
- R31 Rear Personal Lamp LH
- R32 Vanity Lamp Switch RH
- R33 Vanity Lamp Switch LH
- R34 Vanity Lamp RH
- R35 Rain Sensor
- R36 Vanity Lamp LH
- R37 Sunroof Switch
- R38 Sunroof Motor
- I/P-B Connection With I/P JUNCTION BOX Harness

Front Seat LH

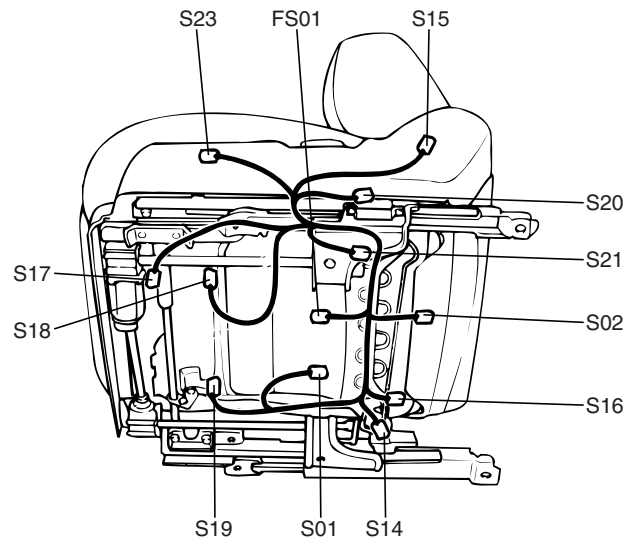

FRONT SEAT LH HARNESS

- S01 Seat Warmer Control Module LH
- S02 Seat Warmer LH
- S14 Slide Limit Switch LH
- S15 Reclining Limit Switch LH
- S16 Reclining Motor LH
- S17 Slide Motor LH
- S18 Front Height Motor LH
- S19 Rear Height Motor LH
- S20 Lumbar Support Switch
- S21 Lumbar Support Motor
- S23 Power Seat Switch LH
- FS01 Connection With FLOOR Harness

Front Seat RH

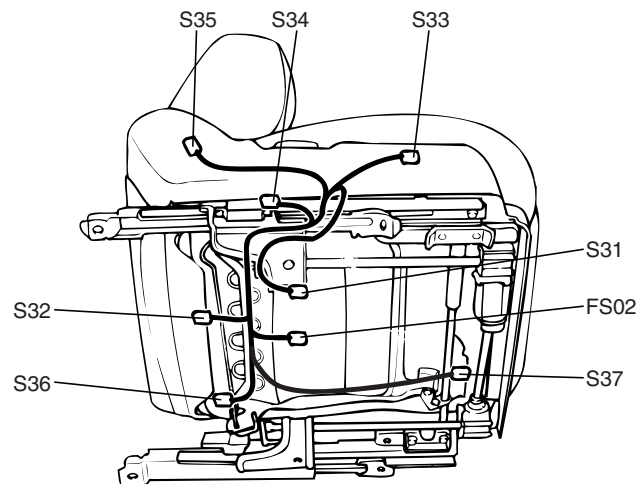

FRONT SEAT RH HARNESS

- S31 Seat Warmer Control Module RH
- S32 Seat Warmer RH
- S33 Power Seat Switch RH
- S34 Slide Limit Switch RH
- S35 Reclining Limit Switch RH
- S36 Reclining Motor RH
- S37 Slide Motor RH
- FS02 Connection With FLOOR Harness